



---

## DESCRIPTION

<b>Typology</b>	Sideboard
<b>Structure</b>	Panel of wooden particles in veneer
<b>Top</b>	Panel of wooden particles in veneer or marble
<b>Feet</b>	Aluminium painted
<b>Shelf</b>	Glass
<b>Drawers structure</b>	Panel of wooden particles melamine

---

## DIMENSIONS

### Two leaf doors, drawer and open compartment

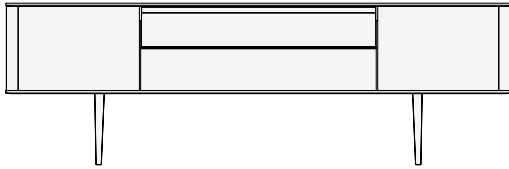

2128  
83 3/4"

680  
26 3/4"

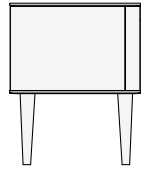

548  
21 1/2"

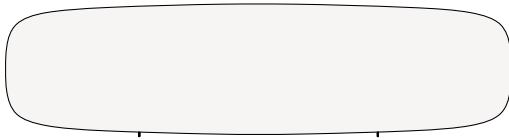

### Two leaf doors and two drawers

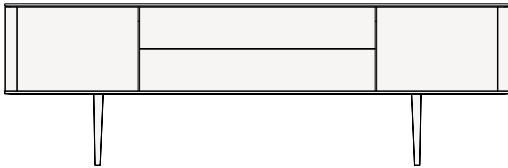

2128  
83 3/4"

680  
26 3/4"

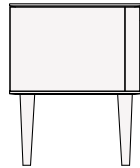

548  
21 1/2"

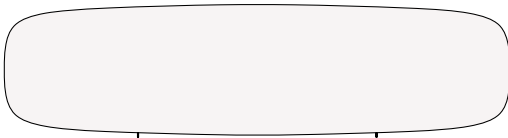

## Two leaf doors and three drawers

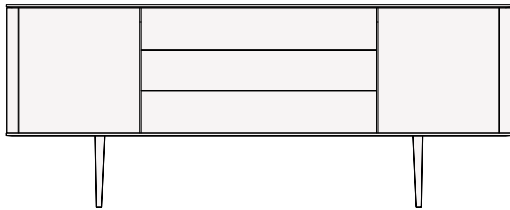

2128  
83 3/4"

855  
33 3/4"

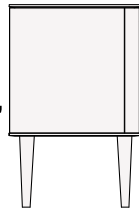

548  
21 1/2"

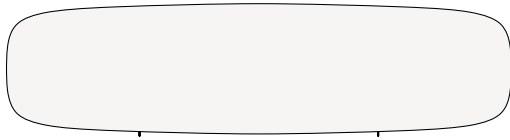

## Two leaf doors

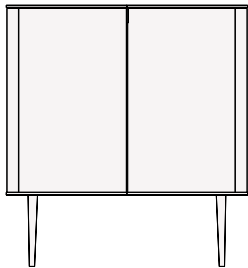

1018  
40"

1100  
43 1/4"

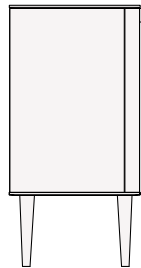

548  
21 1/2"

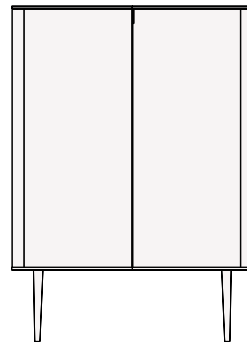

1018  
40"

1400  
55"

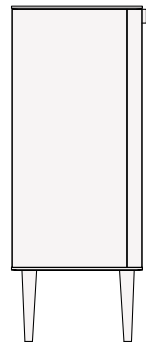

548  
21 1/2"

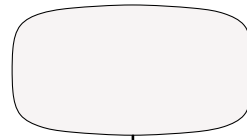
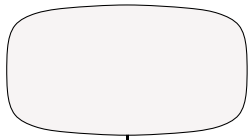

## Two leaf doors, drawer and open compartment

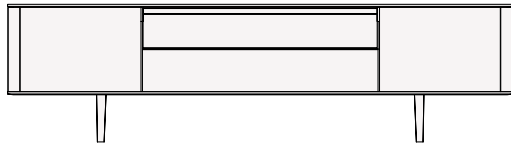

2128  
83 3/4"

580  
22 3/4"

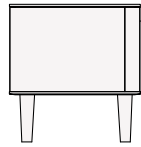

548  
21 1/2"

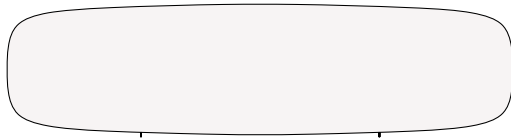

## Two leaf doors and two drawers

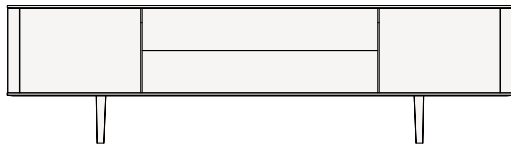

2128  
83 3/4"

580  
22 3/4"

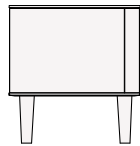

548  
21 1/2"

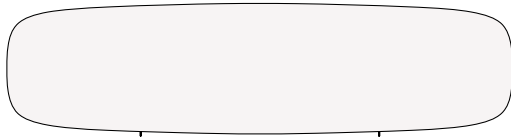

## Two leaf doors and three drawers

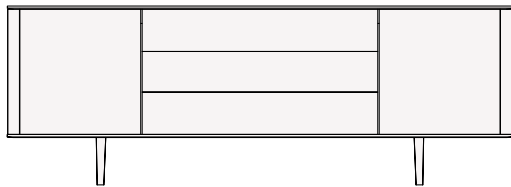

2128  
83 3/4"

755  
29 3/4"

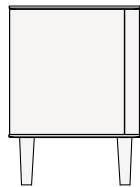

548  
21 1/2"

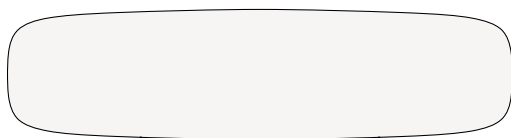

## Two leaf doors

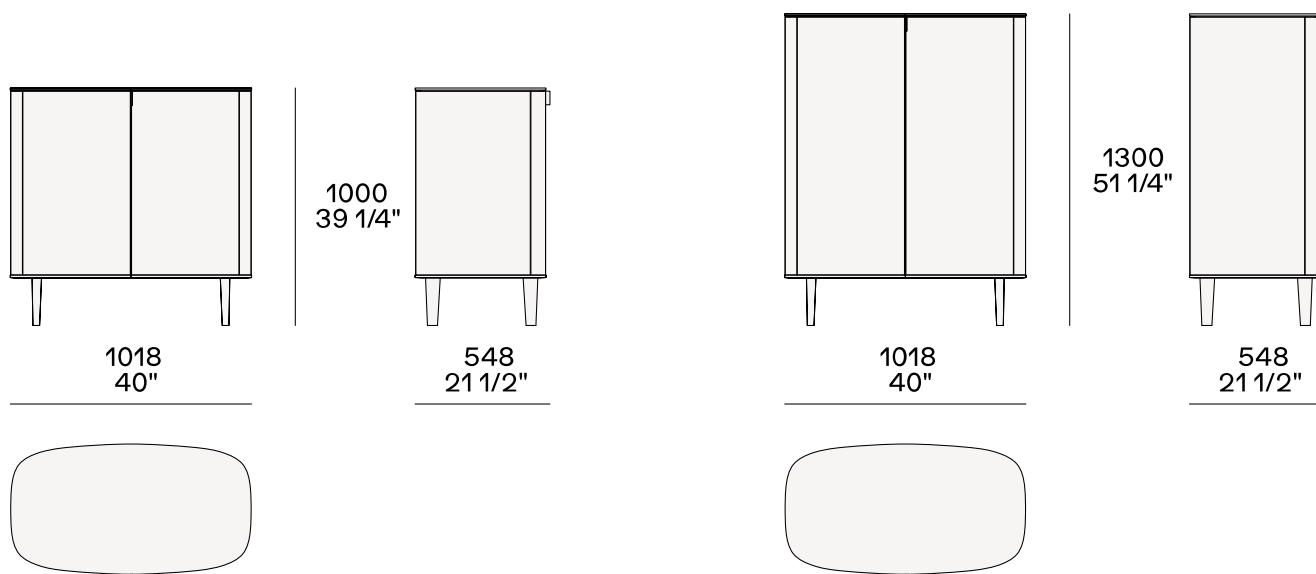

## STRUCTURE FINISHES

### Wood

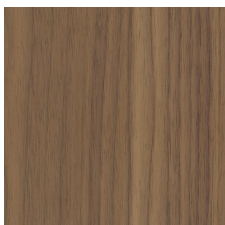

Woods

## BASE FINISHES

### Metal parts



Metal parts

## TOP FINISHES

### Marble

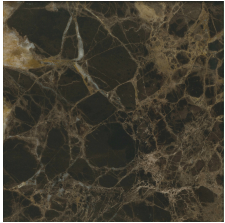

Mat marble

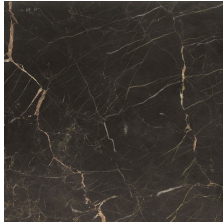

Glossy marble

### Wood

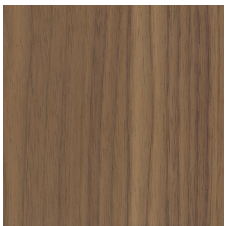

Woods