



---

????????

????????

?????

?????? ?????

26 ??

?????? ??????????

6-12-20-30-40-52 ??

???????? ???? ???? ?????

?? ?????????? ??????

???????? ???? ???? ???? ?

?? ?????????? ??????

???????? ???? ???? ???? ???? ?

???????

???????? ???? ???? ???? ???? ?

? ??????? ???? ???? ???? ???? ? Tip-on

---

??????????

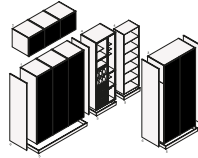
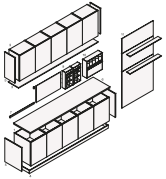

1 ??????

1 ??????

2 ??????

2 ??????? ? ? ? ? ? ? ? ? ?

3 ????????? ? ? ? ? ? ? ? ? ?

3 ??????? ? ? ? ? ? ? ?

?????????

4 ???????, ??????? ? ? ? ? ? ? ? ? ?

4 ???????, ??????? ? ? ? ? ? ? ? ? ?

5 ???????, ??????? ? ? ? ? ? ? ? ? ?

5 ??????? ? ? ? ? ? ? ? ? ? ? ? ? ? ? ?

?????????

?????????

6 ???????, ??????? ? ? ? ? ? ? ? ? ?

7 ???????, ??????? ? ? ? ? ? ? ? ? ?

8 ???????, ??????? ? ? ? ? ? ? ? ? ?

9 ??????, ????????????? ? ? ? ? ? ? ? ? ?

???????? ? ? ? ? ? ? ? ? ?

10 Deep Shaker, ????????????? ? ? ? ? ? ? ? ? ?

??????, ??????? ? ? ? ? ? ? ? ? ?

11 ?????? ? ? ? ? ? ? ? ? ? ? ? ? ? ? ?

?????????

?????



?????? ????  
?????????????? ???? 26 ?? ?  
????????? ? ?????????? ?????? ?  
??????

?????? ????  
?????????????? ???? 26 ?? ?  
????????? ? ?????????? ??????  
??????

???? ???????

???????



??19 ??????? 26 ??

??21 ??????? 26 ?? - 1"

???? ? ????  
????????? ???? 5051 ?  
????????? ???? , ????????? ?  
????????? ????.

???? ? ????  
????????? ???? 5059 ? ????  
? ???? ???? ???? ????  
?????

?? ?????? ? ????  
????????? ???? ??  
????????? ? ????.

?? ?????? ? ????  
????????? ???? ??  
?????, ?????????? ?  
????????? ???? , ????????? ?  
???? ???? . ????????? ??  
????????? ? ????.

???????? ?

## ?????? 12

???? ??. 410



????? 150, 300, 450, 600

?????? ??. 410

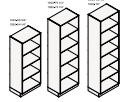

????? 150, 300, 450, 600

?????? ???? ? . 410

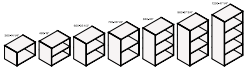

????? 150, 300, 450, 600; ??????  
606, 612, 622, 626 ???  
???????????? ???? ? ????  
????????? 6, 12, 22, 26

## ?????? 26

????? ?????? | 750 p 570

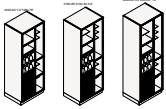

????? ?????? | 750 p 570

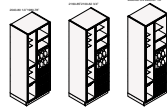

## ?????? 26 Trail

???? ? 300 ? 570



?????? | 300 p 570

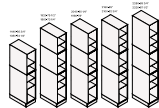

???????? ???? ? 300 ??????  
402

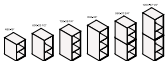

?? POLIFORM

?? Infinity

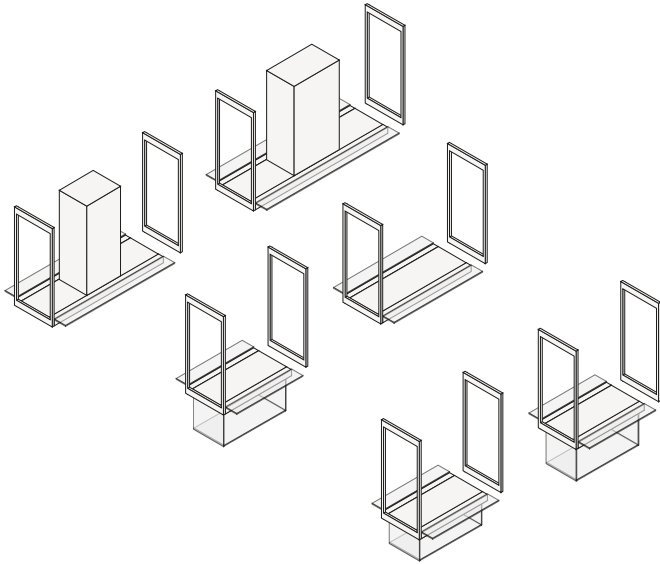

??

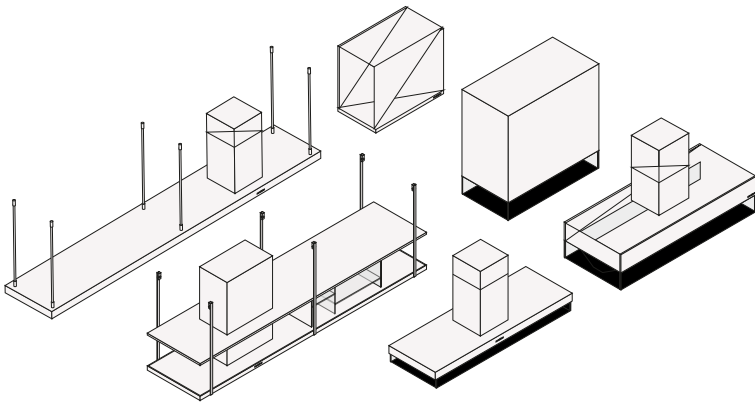

??

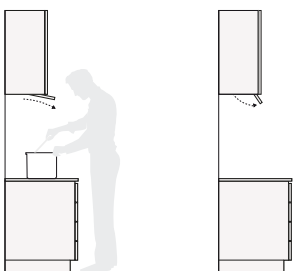

???????????????? ?

## Shaker

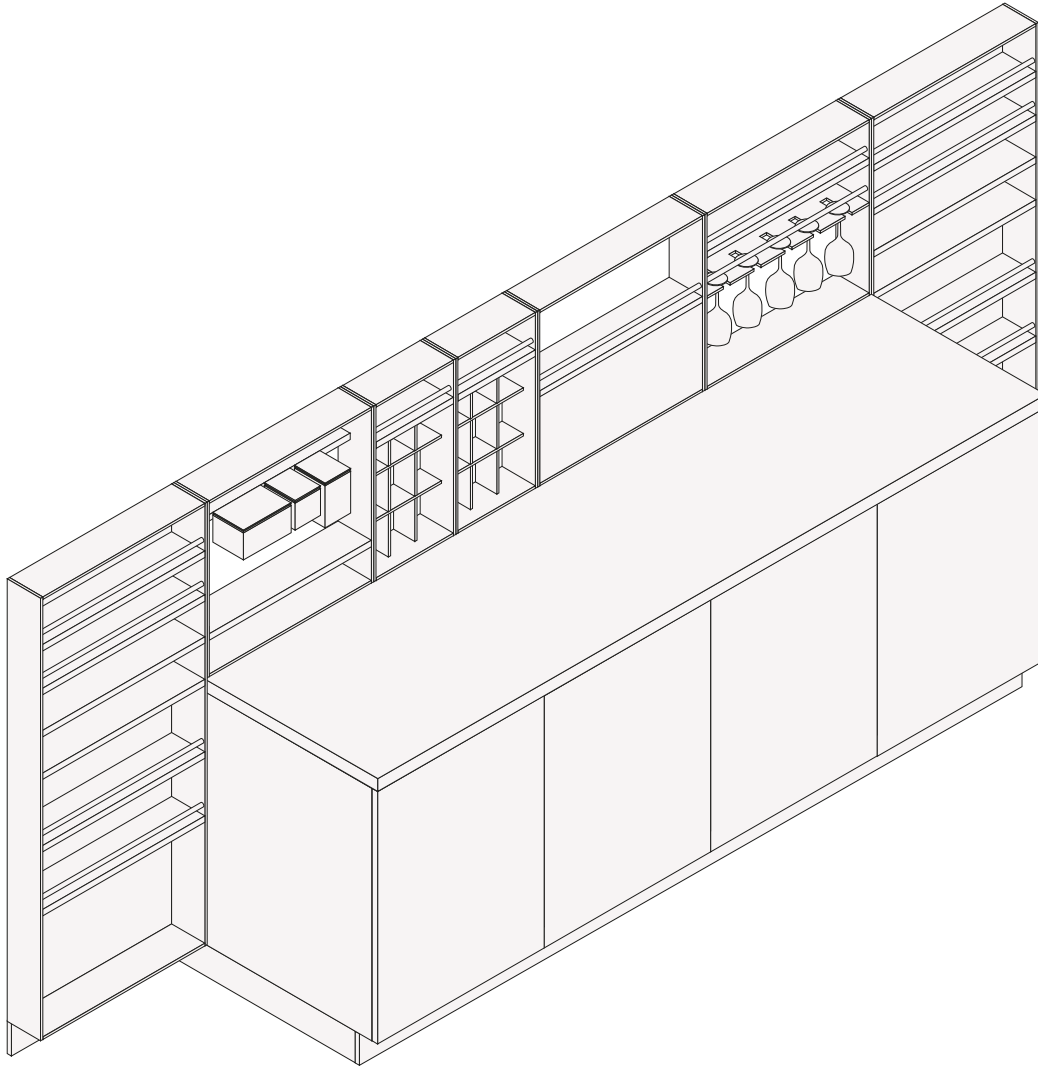

## Deep Shaker

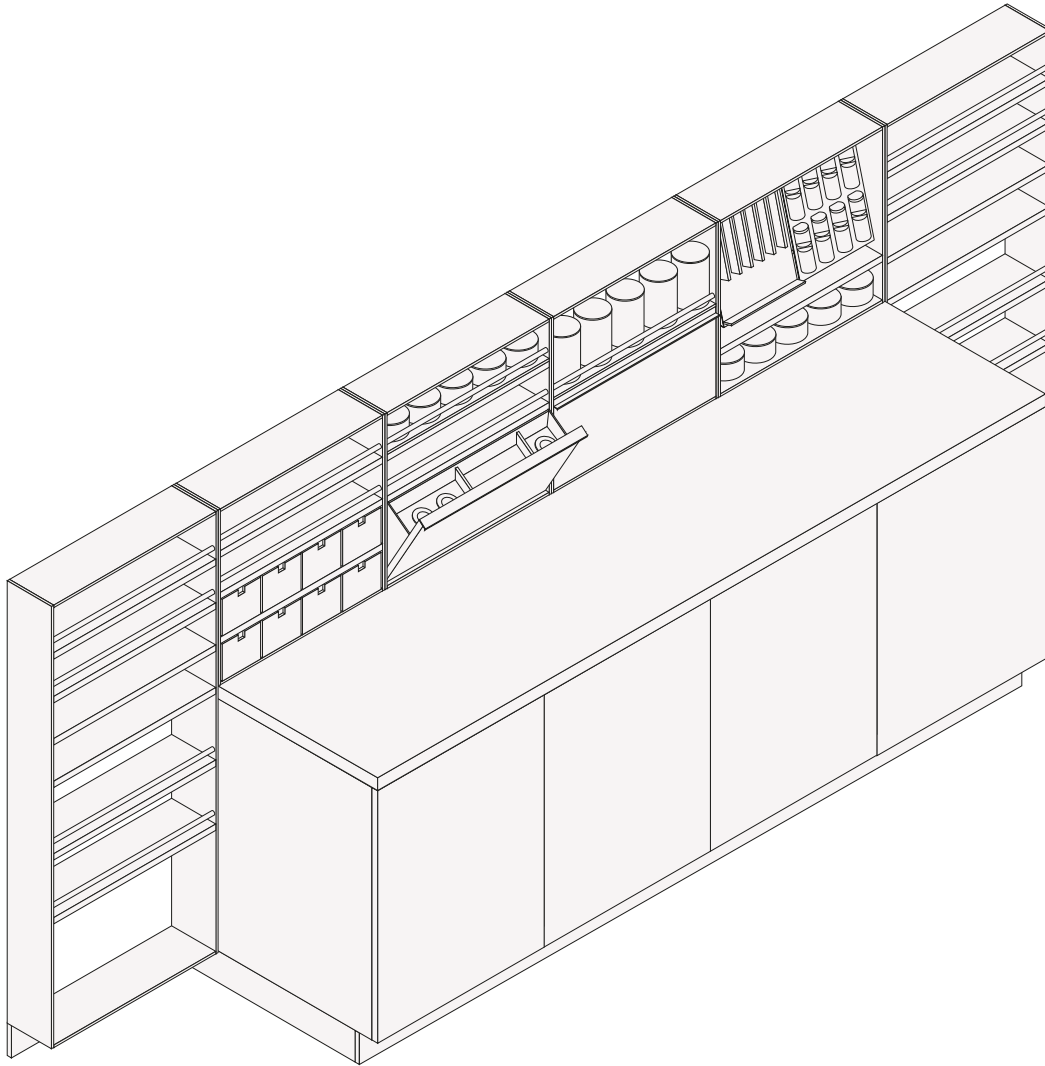

????????????? ??????

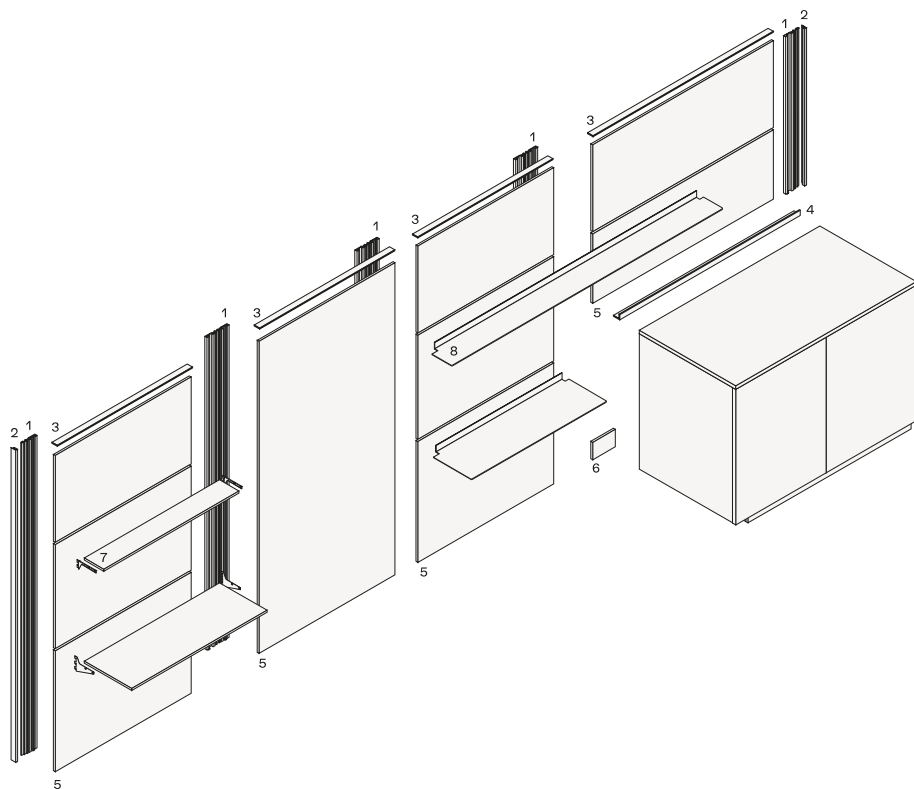

- 1 ?????? ??? ?????????? ????????
- 2 ??????? ????????
- 3 ??????? ????????
- 4 ??????? ??????? ???? ?????????? ??????? ???????
- 5 ????????
- 6 ??????? 150 ? ??? ?????????? ??????? ????? ???????
- 7 ??????? ??????? 12
- 8 ??????? ??????? 3



?????? ?????? ? ???????????

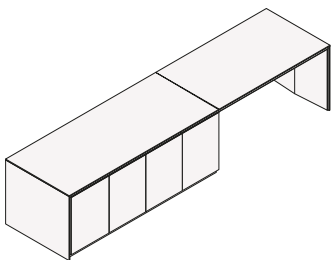
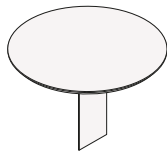
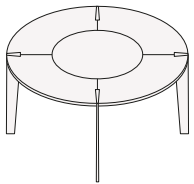
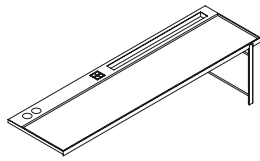
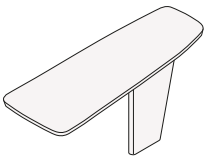
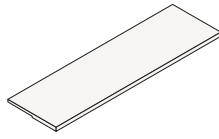
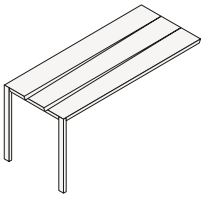
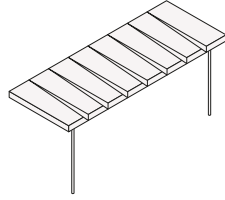
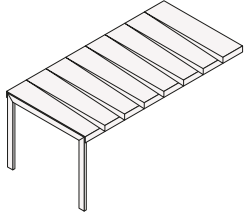

????????????

????????????????

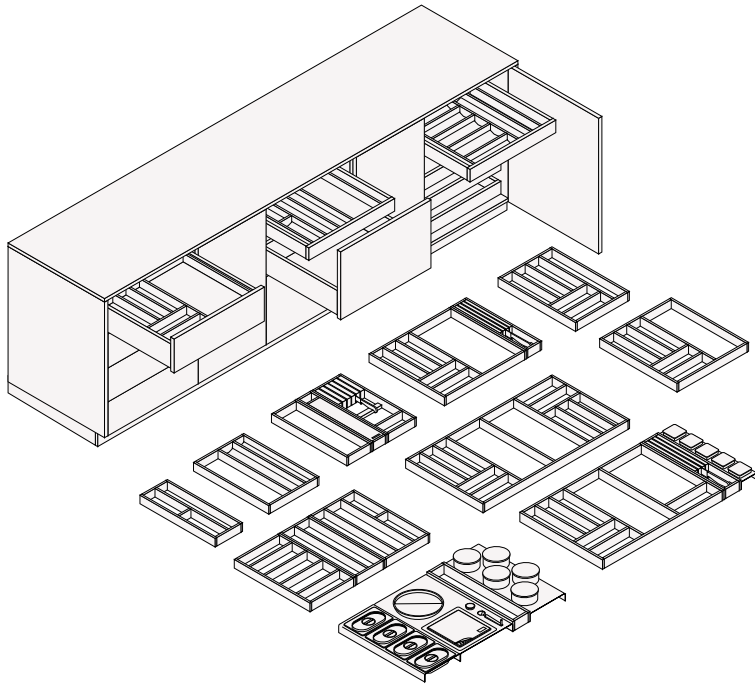

????????????????

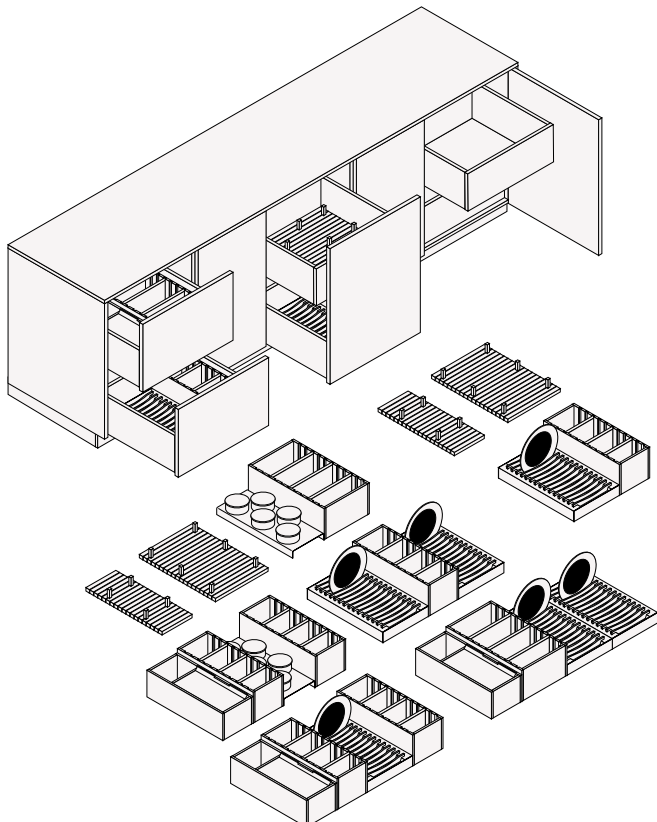



?????? ????????

?????? ????????????

?????? ?????????? ????????????

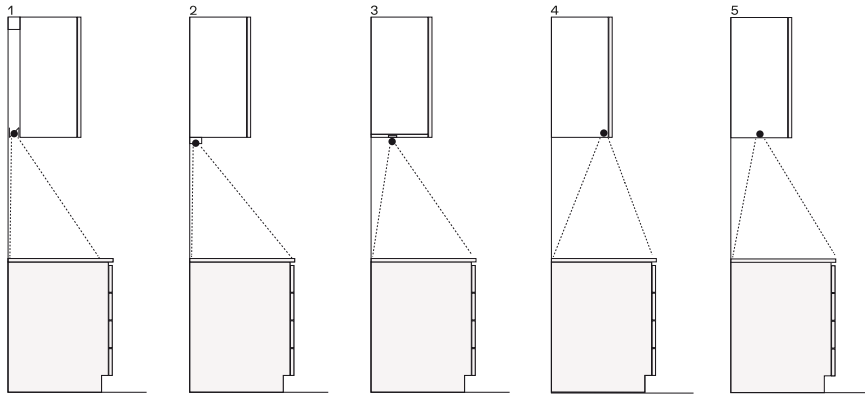

- 1 ??????? ?????? ?????????? ?? ????????????, ?????????? ??????? ??????? 100 ??
- 2 ?????? ?????? ?? ??????? ??????
- 3 ?????? ? ?????????????? ??????????????
- 4 ?????????? ??????? Multi-LED ?? ?????????? ?????? ?? ??????? ?? ???????, ?????????????? ?????? ? ?????????? ?????? d 410
- 5 ?????????????? ??????????, ?????????????? ? ?????? ?????? ?????????? ??????

??????????

?????????? ?????????? ??? ???

1

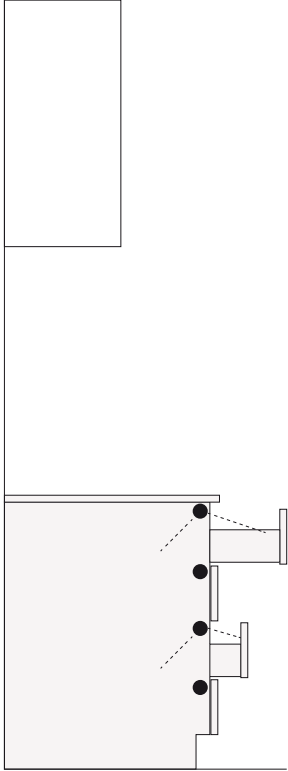

2

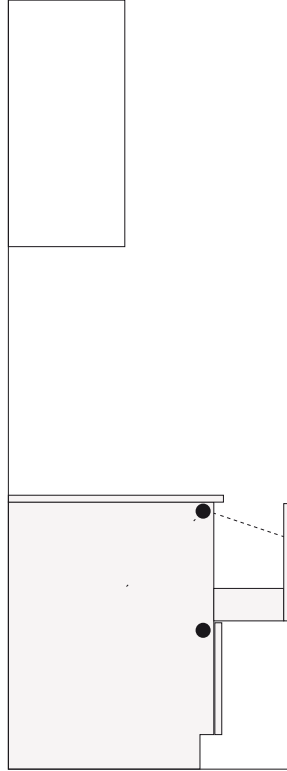

3

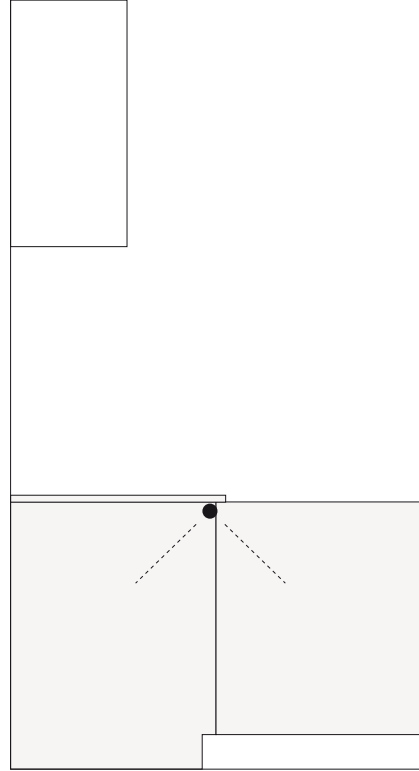

- 1 ??????? ? ?????????????? ?????? Kiton
- 2 ?????????????? ??? ?????????????????????? ????? Kiton
- 3 ?????????? ????? ? ?????????????? ?????????? Kiton

????????? ????????

?????????? ??????????? ???? ????? ? ????????

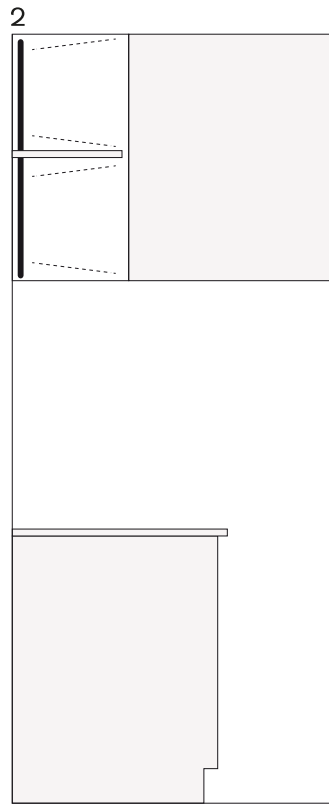
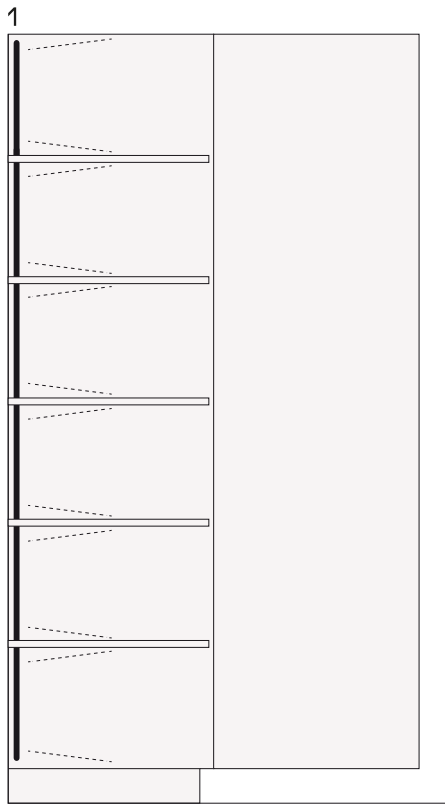

1 ??????? ? ????????????? ?????????????? ??????????????, h ?? 1320 ?? 2280  
2 ?????? ? ????????????? ?????????????? ??????????????, h ?? 360 ?? 1200

???????????????? ????????

?????????? ?????????? ?????????????? ???????

1

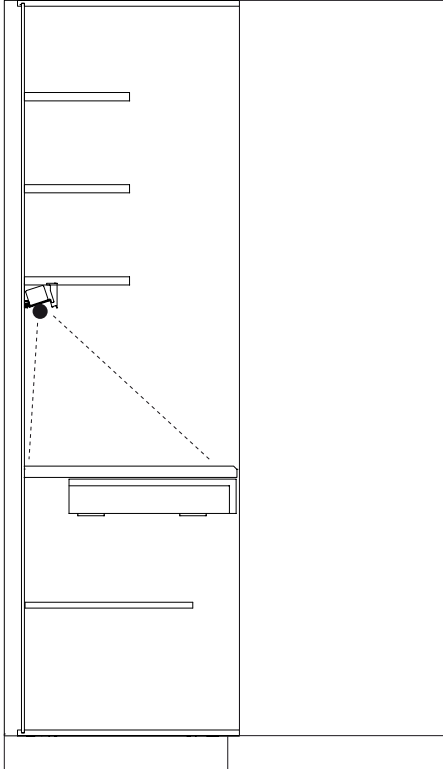

2

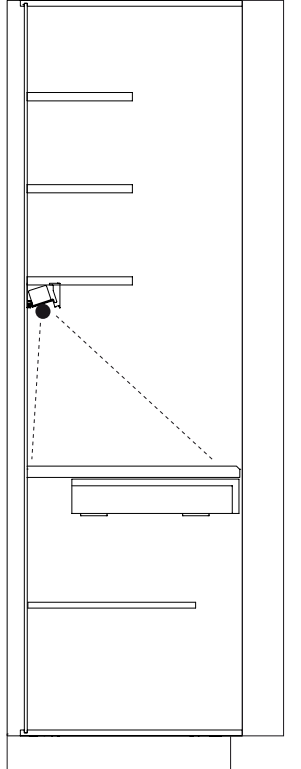

1 ??????? ? ????? ??????????? ? 900, 1200  
2 ??????? ??????? ? ??????? ? ?????????? ??????, 1380 ?.