



介绍

厨房

26mm

6-12-20-30-40-52mm

搭配集成把手

搭配集成把手

型材

搭配弹力隐形把手

组件

Structure item

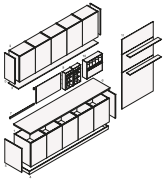

- 1 基础
- 2 个壁挂单元
- 3 柜下面板, 线性元件
- 4 底座, 线性元件
- 5 饰面, 互补元素
- 6 平面, 线性元素
- 7 后挡板, 线性元素
- 8 靠背, 线性元件
- 9 摇床, 配备靠背, 线性元件
- 10 个 Deep
- Shaker, 配备靠背, 线性元件
- 11 Boiserie 和搁板, 线性元素

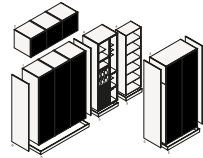

- 1 列
- 列上方的 2 个元素
- 3 根高柱
- 每天 4 篇文章
- 5 踢脚板, 线性元素
- 6 饰面, 附加元素

门

Structure item



门厚

26

毫米开口边缘，带成型和中央集成手柄

门厚

26

毫米开口边缘，带成型和中央集成手柄

饰面

Structure item

玻璃橱柜

Structure item



PR19 厚度26 毫米

PR21 厚度26 mm - 1"

门采用古铜色 5051
反光玻璃，带有青铜漆铝框。

5059
烟熏反光玻璃门，带有摩卡阳极氧化铝框架。

用于具有较低轮廓开口或倾斜开口的壁挂单元。
对于高柜，打开带有涂有摩卡咖啡色的一体式把手。
用于过柱元素的尖端开口。

起居空间元素

12

基地第 410 页



宽度 150, 300, 450, 600

列第 410 页

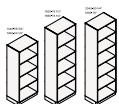

宽度 150, 300, 450, 600

高柜与 410



宽度 150、300、450、600；宽度
606、612、622、626 用于在细边为
6、12、22、26 的底座上调平

26

右栏 1 750 p 570

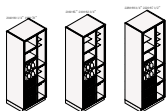

左栏 1 750 p 570

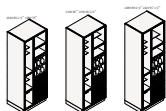

26 Trail

底座 1 300 p 570



立柱 1 300 p 570

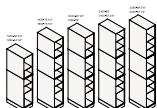

300 页的壁挂单元 402

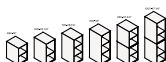

POLIFORM 定制遮罩

Infinity

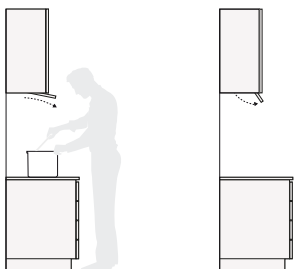
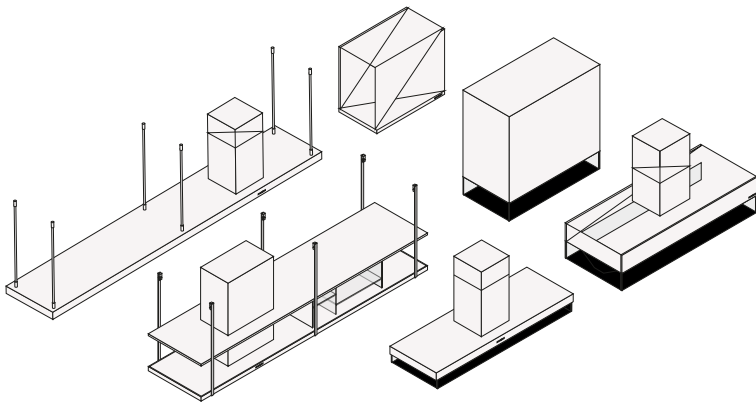
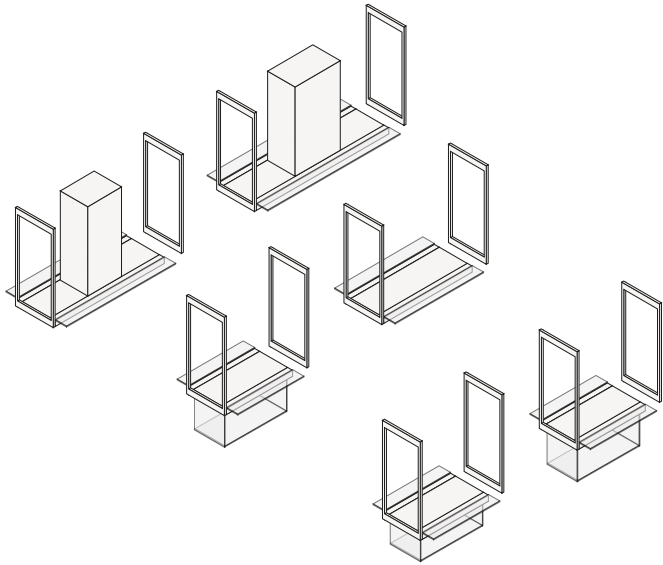

整装背板

Structure item

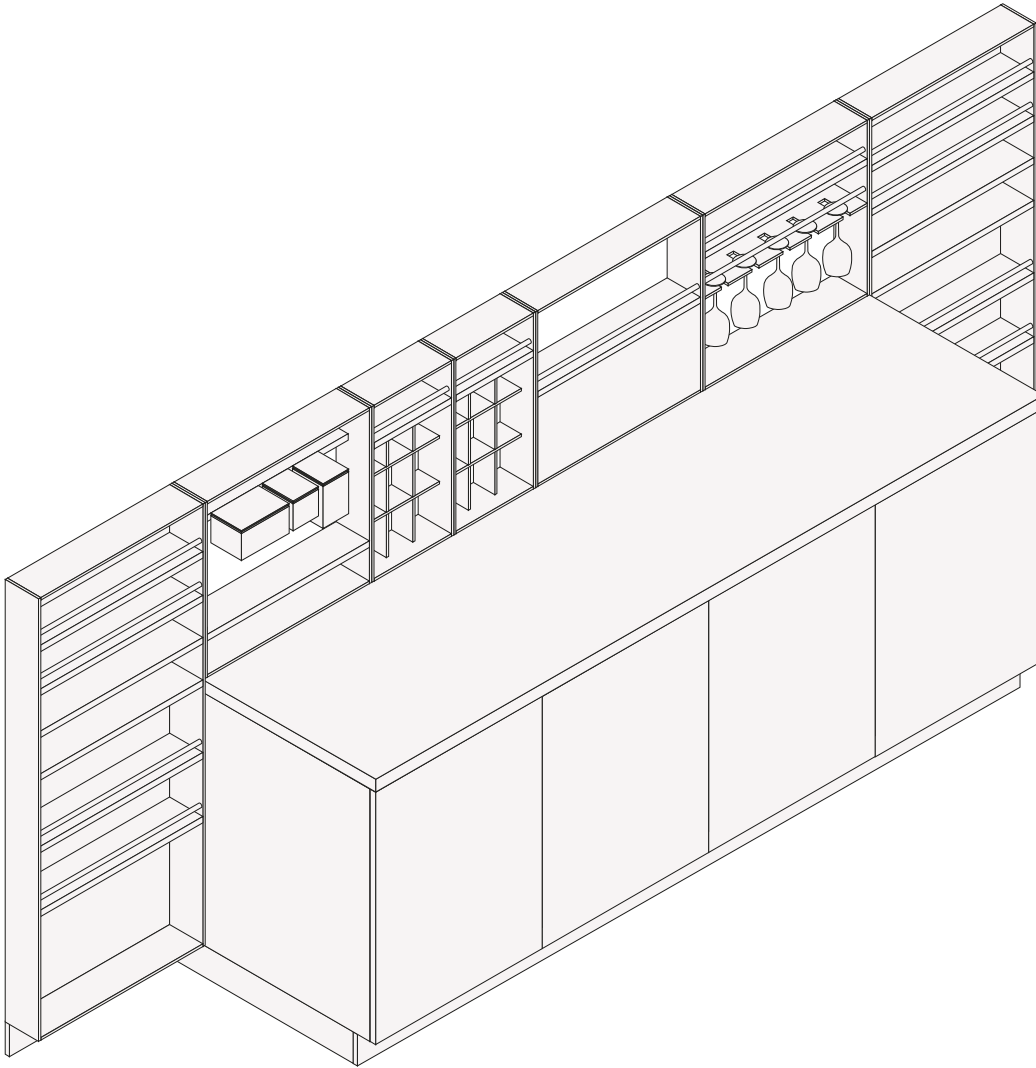

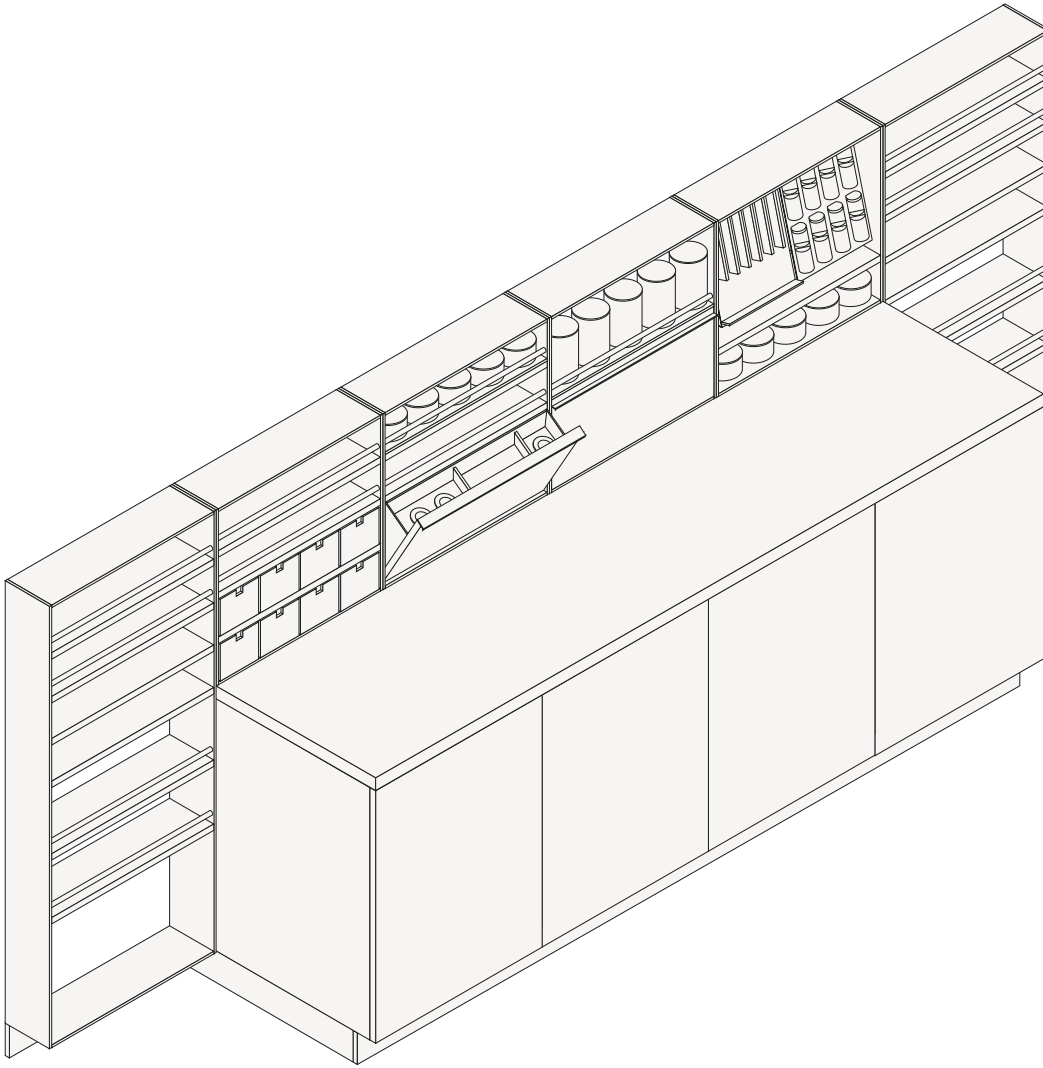

护壁板

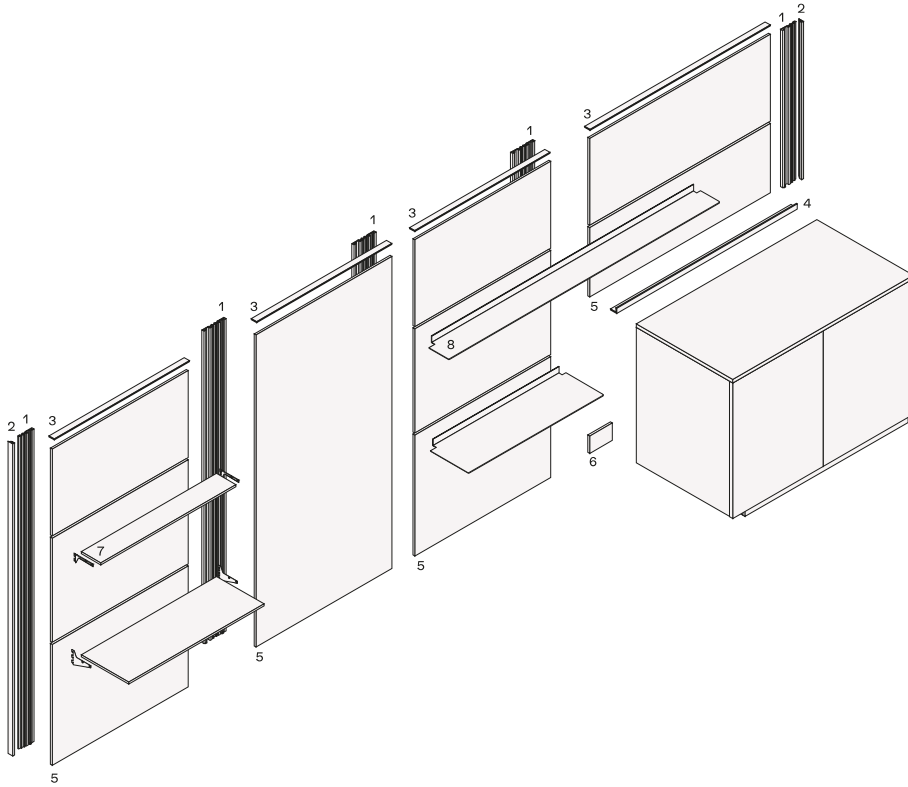

- 1 支持壁挂式安装
- 2 侧面轮廓
- 3 顶级配置文件
- 4 角型材从上方支撑护墙板
- 5 布瓦塞里
- 6 150 1 用于填充底座支撑框架的盖子
- 7 货架厚度12
- 8 搁板厚度3

小吃搁板

Structure item

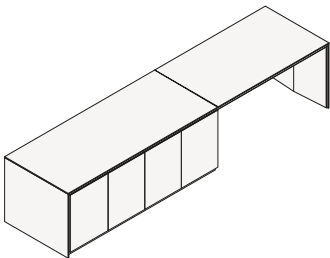
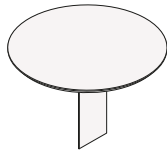
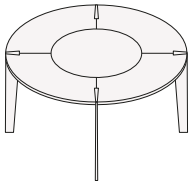
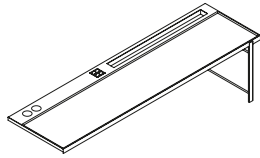
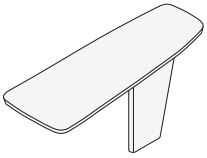
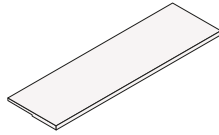
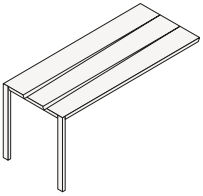
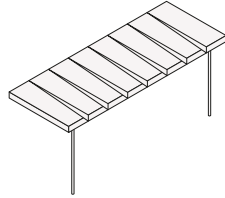
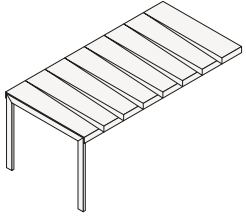

装置

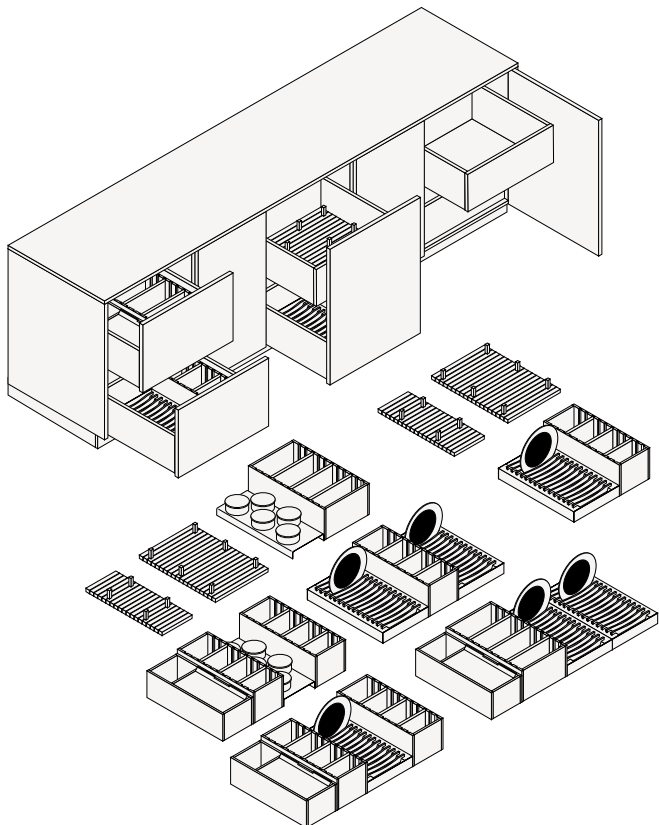
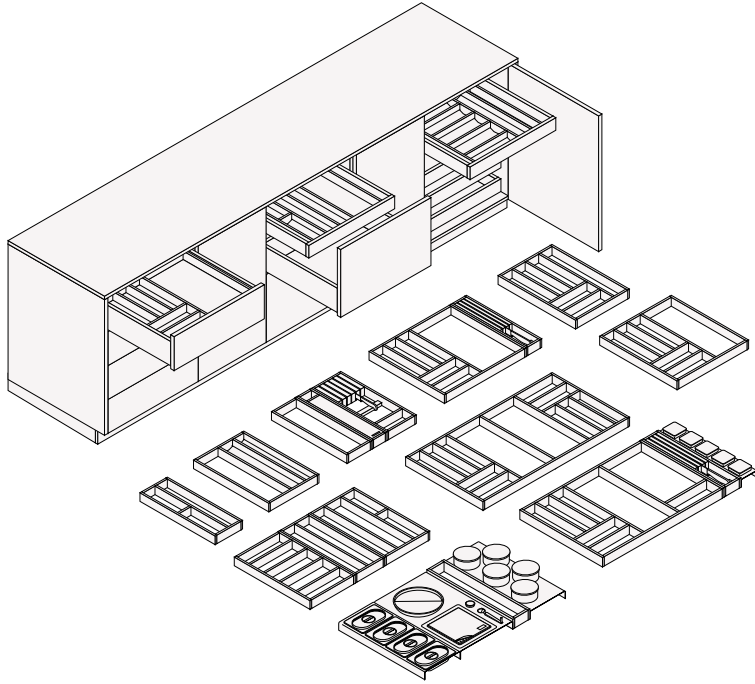

照明系统

户外吊灯

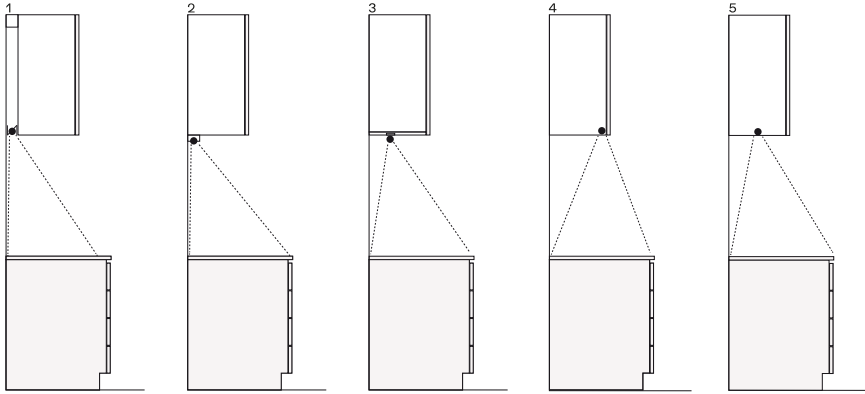

- 1 个带LED的后悬挂杆，先进的100mm高杆解决方案
- 2 高柜下的吧台
- 3 个带多个LED的通道
- 4 用于壁柜或洗碗机的多LED灯型材，仅用于d 410壁柜
- 5 集成在壁挂单元下部的双色投影仪

底座内部照明

1

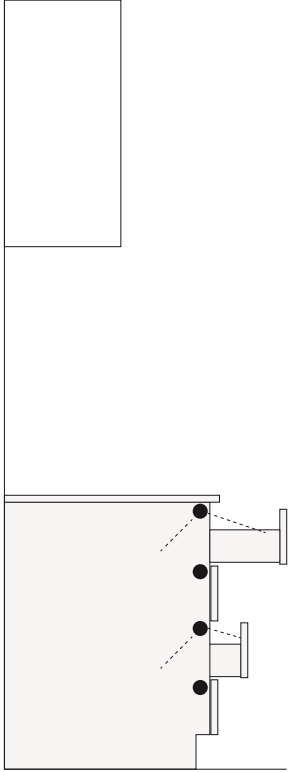

2

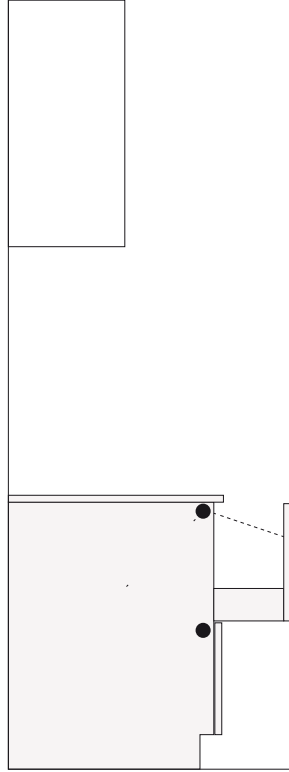

3

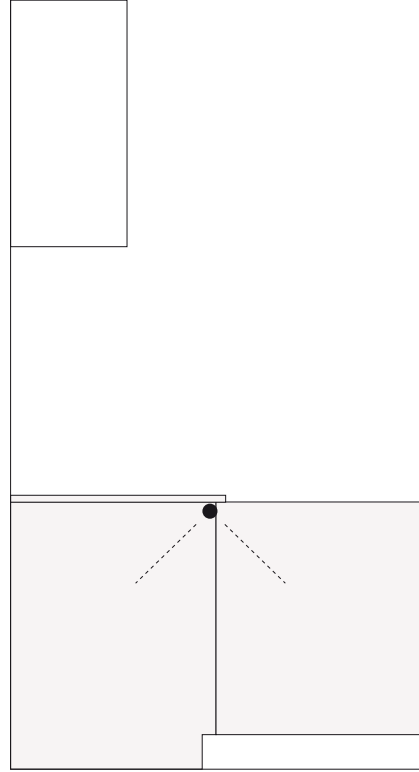

- 1 个带有彩色Kiton 灯的盒子
- 2 Kiton 多功能灯的提取器
- 3 带多色Kiton 灯的铰链门

用于柱和悬挂的室内灯具

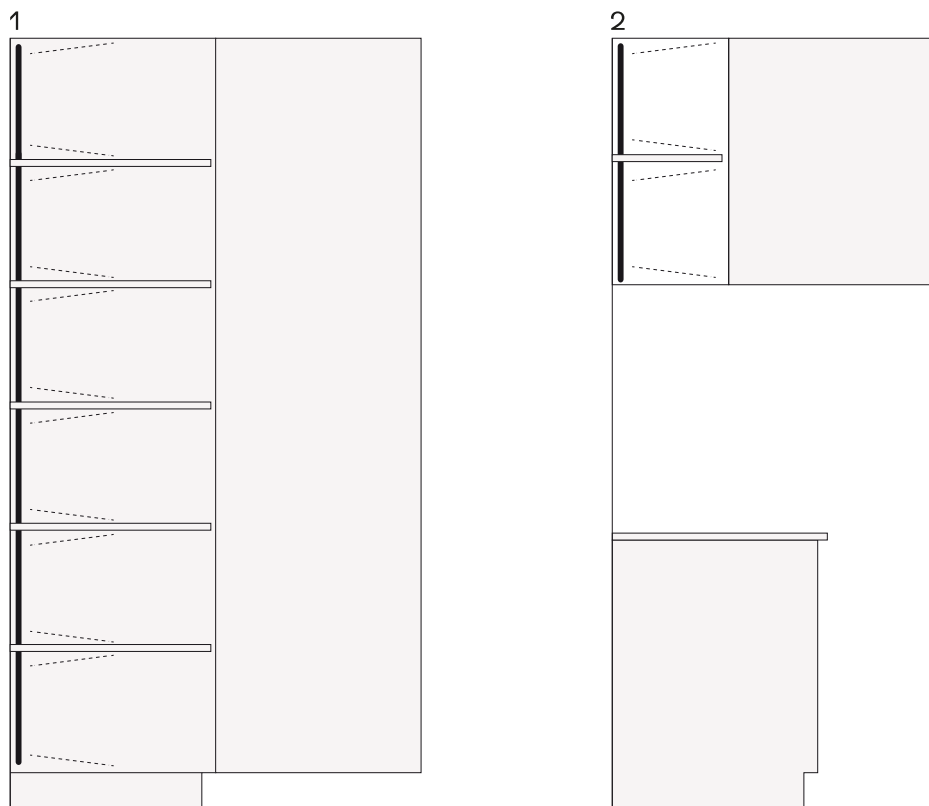

- 1 带有多排垂直灯的柱子, h 从 1320 到 2280
- 2 个带多层垂直灯的壁挂单元, h 从 360 到 1200

配备柱子的内部照明

1

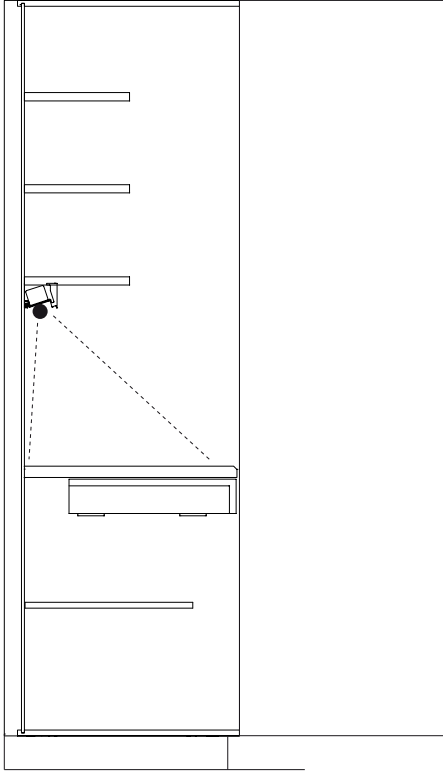

2

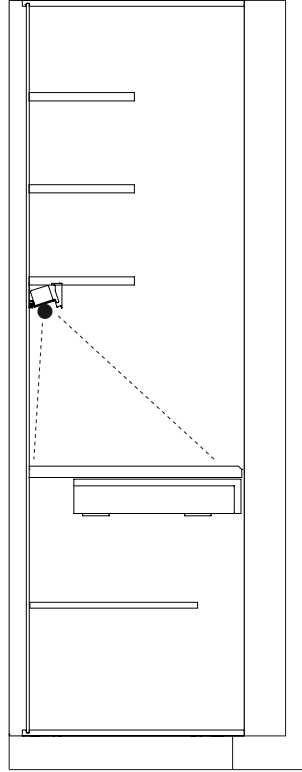

1 列总开口 1900, 1200

2 根高柱和一根带铰链门的柱, 1380 升。