

BRISTOL



**Poliform**

**Poliform**

Poliform è una delle realtà più significative nel mondo dell'arredamento internazionale per qualità del design, eccellenza del progetto e innovazione. Il suo talento è il saper fare, una capacità che unisce cultura e conoscenza e che prima di essere un gesto, il gesto che rende riconoscibile tutto ciò che è firmato Poliform, è un'idea di progettazione. Un pensiero che unisce ricerca di funzionalità, contenuti espressivi e significati, e che della combinazione tra estetica e utilità ha saputo fare un'arte, in ogni area della casa. Nella collezione di imbottiti, quest'arte si esprime attraverso sistemi di divani pensati per arredare i living più esclusivi all'insegna della bellezza e del comfort – tra design eccellente, materiali pregiati e lavorazioni sartoriali.

Poliform is one of the world's leading furniture companies. It stands out for design quality, project excellence, and innovation. Its know-how brings together culture and knowledge. Before becoming a gesture – the gesture that makes everything signed Poliform recognizable – it is a design idea. A thought process that combines the search of function, expressive content, and meaning, and that masterfully merges aesthetics with utility in every area of the house. In the Sofa collection, this art is expressed through systems that bring beauty and comfort to the most exclusive living rooms – thanks to excellent design, fine materials and tailored details.

BRISTOL

INTERIOR 01	10
INTERIOR 02	21
SOFT DETAILS	32
INTERIOR 03	57
INTERIOR 04	69
INTERIOR 05	79
COMPOSITIONS	89
TECHNICAL DATA	115

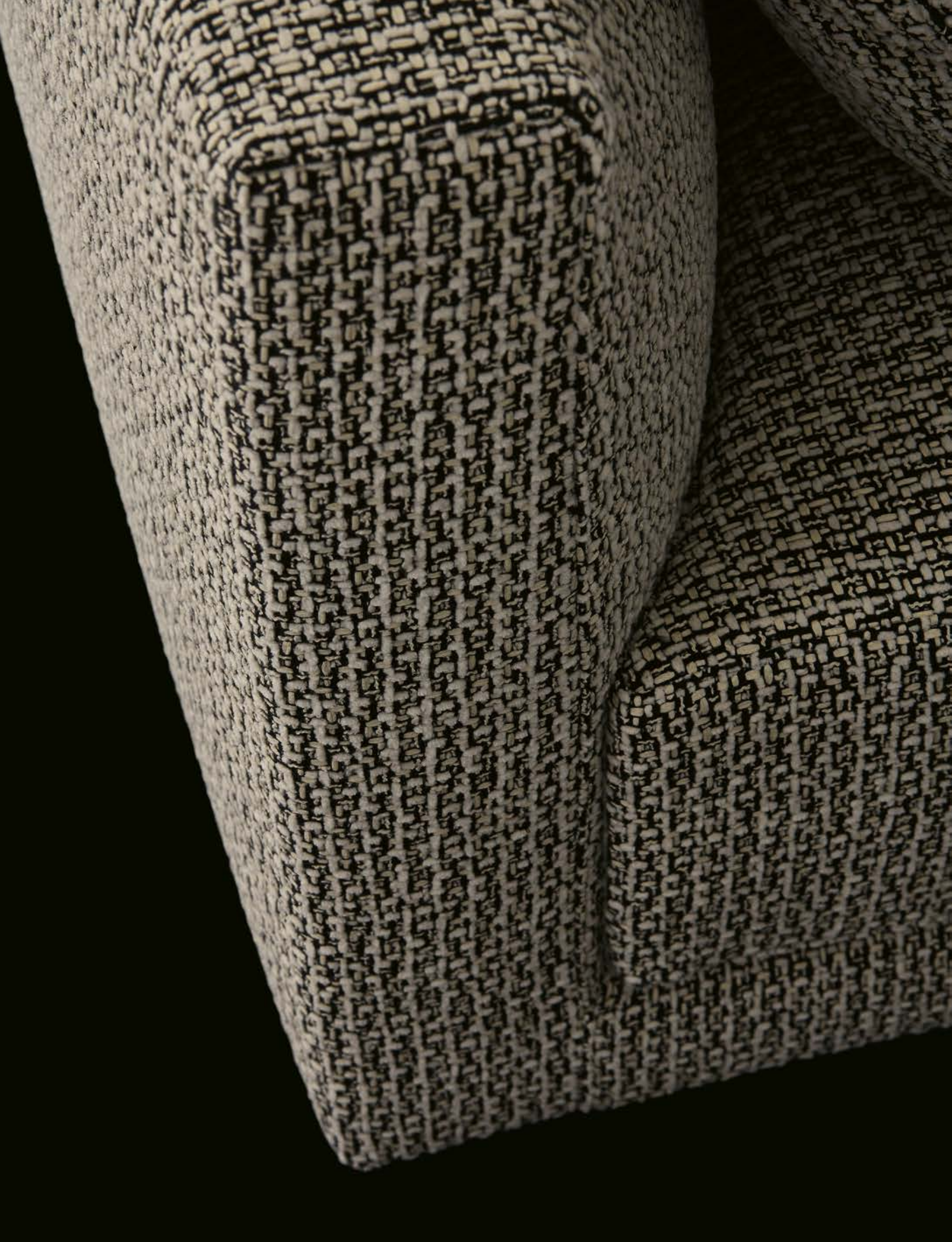

# BRISTOL

Il comfort avvolgente della cuscinatura e la leggerezza dei braccioli contraddistinguono l'estetica di Bristol, sistema disegnato da Jean-Marie Massaud nel 2013 e reinterpretato alla luce delle più attuali esigenze di comfort. Il sistema offre la massima versatilità compositiva: disponibile sia in versione fissa sia componibile, in quest'ultimo caso si configura a piacere per creare divani lineari, ad angolo, oppure nelle più contemporanee forme curve, che si realizzano con l'elemento angolare inclinato. Bristol è disponibile con cuscinatura semplice, doppia, libera o comfort, con soffice imbottitura in piuma.

The enveloping comfort of the cushions and the lightness of the armrests distinguish the style of Bristol, a system designed by Jean-Marie Massaud in 2013 and reinterpreted to meet the actual comfort needs. The system offers maximum compositional versatility: available in fixed or modular version. The modular version can be composed to create linear, corner or more contemporary curved shapes that can be realized using the inclined corner element. Available with simple, double, free or comfort cushions with soft feather padding.











Qui, nelle pagine precedenti e nella successiva: divano Bristol con cuscinatura comfort, rivestimento sfoderabile in tessuto Sheffield 01 pepe, cuscini poggiatesta in tessuto Dundee 01 pepe e cuscini opzionali in tessuto Norwich 01 bianco. Bracciolo fisso con struttura in brown nickel lucido. Libreria Lexington con montanti a parete in olmo nero e ardesia opaco. Ripiani in olmo nero e ardesia opaco. Contenitori con ante a ribalta e cassetti in olmo nero con maniglie in nickel ardesia. Tavolini Mondrian con struttura verniciata brown nickel lucido e piani in marmo verde lepanto opaco. Poltrona Mad Chair con rivestimento sfoderabile in velluto Persia 1404 carbone e gambe in olmo nero. Boiserie Code in tessuto lino bruciato e profili in champagne opaco, mensolone in olmo nero. Tappeto Plain natural.

Here, previous pages and following page: Bristol sofa with backrest cushion comfort, removable cover in fabric Sheffield 01 pepe, lower back cushions in fabric Dundee 01 pepe and optional cushions in fabric Norwich 01 bianco. Fixed armrest with structure in glossy brown nickel. Lexington bookcase with wall mounted uprights in black elm and mat ardesia with levelling feet in nickel ardesia. Shelves in black elm and mat ardesia. Storage units with flap doors and drawers in black elm with nickel ardesia handles. Mondrian coffee tables with glossy brown nickel painted structure and tops in mat marble verde lepanto opaco. Mad Chair armchair with removable cover in velvet Persia 1404 carbone and black elm legs. Code wall panelling in fabric lino bruciato and mat champagne profiles, thick shelf in black elm. Carpet Plain natural.



## BRISTOL

Design Jean-Marie Massaud

### Bristol divano

Cuscineria comfort, rivestimento in tessuto sfoderabile Sheffield 01 pepe, cuscini poggiatesta tessuto sfoderabile Dundee 01 pepe, cuscini opzionali tessuto sfoderabile Norwich 01 bianco, piedini arretrati in materiale plastico. Bracciolo fisso con struttura brown nickel lucido.

### Mad Chair poltrona

Velluto sfoderabile Persia 1404 carbone, gambe in olmo nero.  
l 810 p 770 h 700

### Mondrian tavolini

Struttura verniciata brown nickel opaco. Piano in marmo verde lepanto levigato.  
1400x700 h 290

### Bristol sofa

Backrest cushion comfort, cover in removable fabric Sheffield 01 pepe, lower back cushions in removable fabric Dundee 01 pepe, optional cushions in removable fabric Norwich 01 bianco, invisible feet in plastic material. Fixed arm with structure glossy brown nickel.

### Mad Chair armchair

Removable velvet Persia 1404 carbone, legs in black elm.  
w 32" d 30 1/4" h 27 1/2"

### Mondrian coffee tables

Structure painted mat brown nickel. Top in mat marble verde lepanto.  
55"x27 1/2" h 11 1/2"

### Bristol divano Bristol sofa

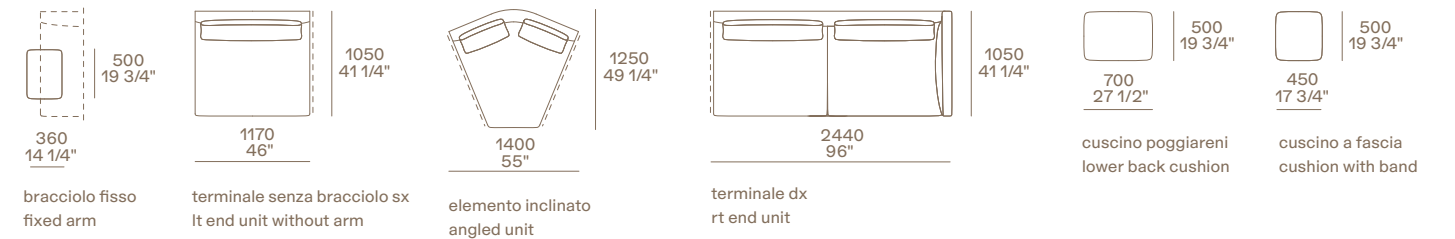
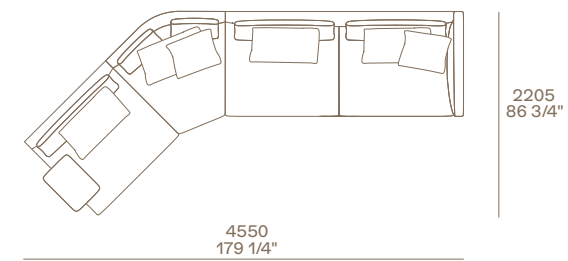

### Mad Chair poltrona Mad Chair armchair

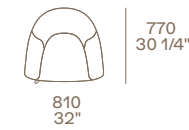

### Mondrian tavolino Mondrian coffee table

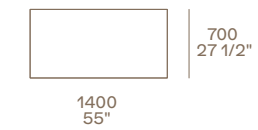









Qui, nelle pagine precedenti e nella successiva: divano Bristol con cuscineria comfort, rivestimento sfoderabile in tessuto Brest 02 salvia, cuscini poggiatesta in velluto Tebe 07 oliva e cuscini opzionali in tessuto Brest 02 salvia. Libreria Lexington con montanti a soffitto in rovere gold e champagne opaco con piedini di regolazione in nickel champagne. Ripiani in rovere gold e champagne opaco. Contenitori con cassetti in rovere gold con maniglie in nickel champagne. Poltrona Mad Joker in pelle non sfoderabile Nabuk 10 oliva, basamento girevole brown nickel lucido. Tavolini Mondrian, rettangolari con piano in marmo verde lepanto levigato e struttura verniciato brown nickel lucido; rotondo con piano in laccato lucido moka e struttura verniciato brown nickel lucido; rotondo con piano in olmo nero e struttura in fusione di bronzo lucidata oro. Tappeto Plain natural.

Here, previous pages and following page: Bristol sofa with backrest cushion comfort, removable cover in fabric Brest 02 salvia, lower back cushions in velvet Tebe 07 oliva and optional cushions in fabric Brest 02 salvia. Lexington bookcase with floor to ceiling uprights in gold oak and mat champagne with levelling feet in nickel champagne. Shelves in gold oak and mat champagne. Storage units with drawers in gold oak with nickel champagne handles. Mad Joker armchair in non-removable leather Nabuk 10 oliva, swivel base in glossy brown nickel. Mondrian coffee tables, rectangular with tops in mat marble verde lepanto and glossy brown nickel painted structure; round with top in glossy lacquer moka and glossy brown nickel painted structure; round with top in black elm and structure in gold polished bronze casting. Carpet Plain natural.





## BRISTOL

Design Jean-Marie Massaud

### Bristol divano

Cuscineria comfort, rivestimento in tessuto sfoderabile Brest 02 salvia, cuscini poggiatesta velluto sfoderabile Tebe 07 oliva, cuscini opzionali tessuto sfoderabile Brest 02 salvia, piedini opzionali brown nickel lucido.

### Mad Joker poltrona

Pelle non sfoderabile Nabuk 10 oliva, basamento girevole brown nickel lucido. l 800 p 800 h 1085

### Mondrian tavolini

Struttura verniciata brown nickel lucido, piani in marmo verde lepanto levigato 1400x700 h 290; laccato lucido moka Ø 1000 h 380.

Struttura fusione di bronzo lucidata oro, piano olmo nero. Ø 550 h 480

### Bristol sofa

Backrest cushion comfort, cover in removable fabric Brest 02 salvia, lower back cushions in removable velvet Tebe 07 oliva, optional cushions in removable fabric Brest 02 salvia, optional feet glossy brown nickel.

### Mad Joker armchair

Non-removable leather Nabuk 10 oliva, swivel base glossy brown nickel. w 31 1/2" d 31 1/2" h 42 3/4"

### Mondrian coffee tables

Structure painted glossy brown nickel, tops in mat marble verde lepanto 55"x27 1/2" h 11 1/2"; glossy lacquer moka Ø 39 1/4" h 15".

Structure in gold polished bronze casting, top in black elm. Ø 21 3/4" h 19"

### Bristol divano Bristol sofa

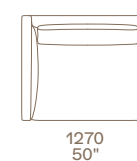
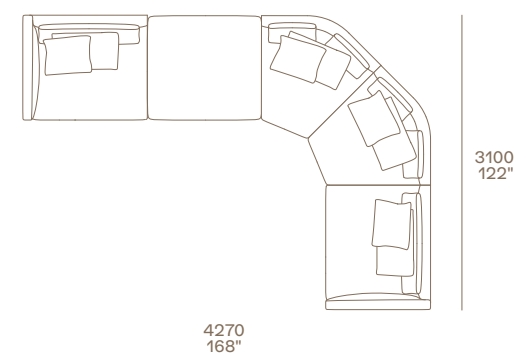

terminale sx  
lt end unit

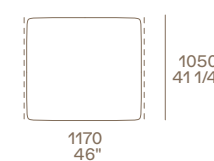

pouf centrale  
central unit pouf

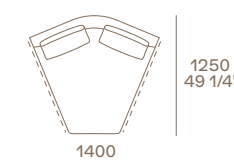

elemento inclinato  
angled unit

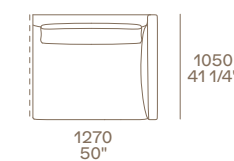

terminale dx  
rt end unit

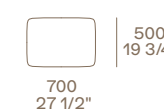

cuscino poggiatesta  
lower back cushion

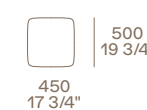

cuscino a fascia  
cushion with band

### Mad Joker poltrona Mad Joker armchair



### Mondrian tavolini Mondrian coffee tables

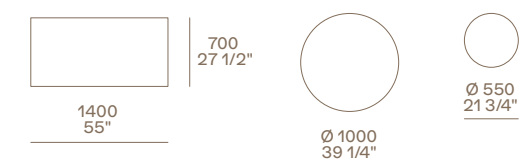

# Soft details



I cuscini poggiatesta in piuma d'oca conferiscono al divano morbidezza e comfort.  
Sono studiati per essere usati anche in verticale, come poggiatesta.  
The feather kidneyrest cushions give softness and comfort to the sofa.  
They are studied to be used also in vertical position as headrest.





La cuscineria comfort, con soffice imbottitura in piuma e confezionamento a fascia, offre allo stesso tempo il massimo della comodità e perfetto sostegno.  
The comfort cushion with soft feather padding with band offers maximum comfort and perfect support.



L'elemento angolare inclinato si integra agli altri elementi del sistema per creare composizioni curve, eleganti e contemporanee.  
The inclined corner element perfectly integrates with other elements of the system to create curved, elegant and contemporary compositions.





A seconda della configurazione scelta, l'elemento angolare inclinato si può usare sia come terminale sia in posizione centrale.  
According to the selected composition, the inclined corner element can be used both in terminal and central position.

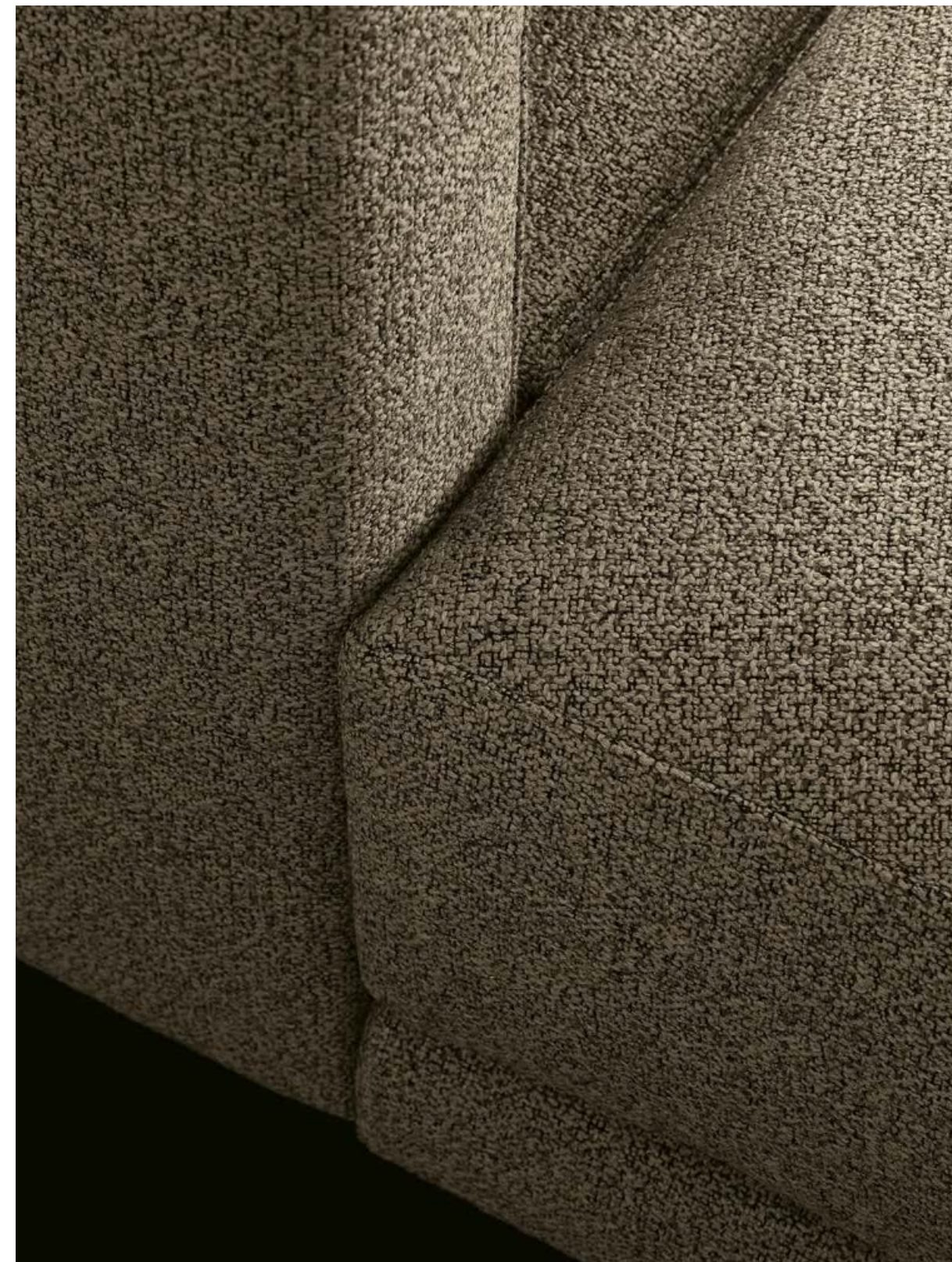

Gli elementi angolari inclinati, disponibili con schienale o in versione pouf, possono anche essere affiancati tra loro.  
The inclined corner element, available with backrest or in pouf version, can be placed side by side.





Due le tipologie di piedino: a cilindro leggermente rientranti, che danno al divano un aspetto sospeso, oppure in alluminio, dal design geometrico e deciso.  
Two types of feet: cylinder slightly re-entrant that give a suspended aspect to the sofa or in aluminum with strong and geometric design.



Linee classiche per il divano con cuscineria singola e rivestimento in pelle con cucitura ribattuta.  
Classic lines for the sofa with single cushion and leather cover with felled seam.







L'elemento poggiatesta, inserito tra struttura e cuscinatura doppia, rende il divano ancora più confortevole.  
The headrest element, placed between the structure and the double cushion gives more comfort to the sofa.

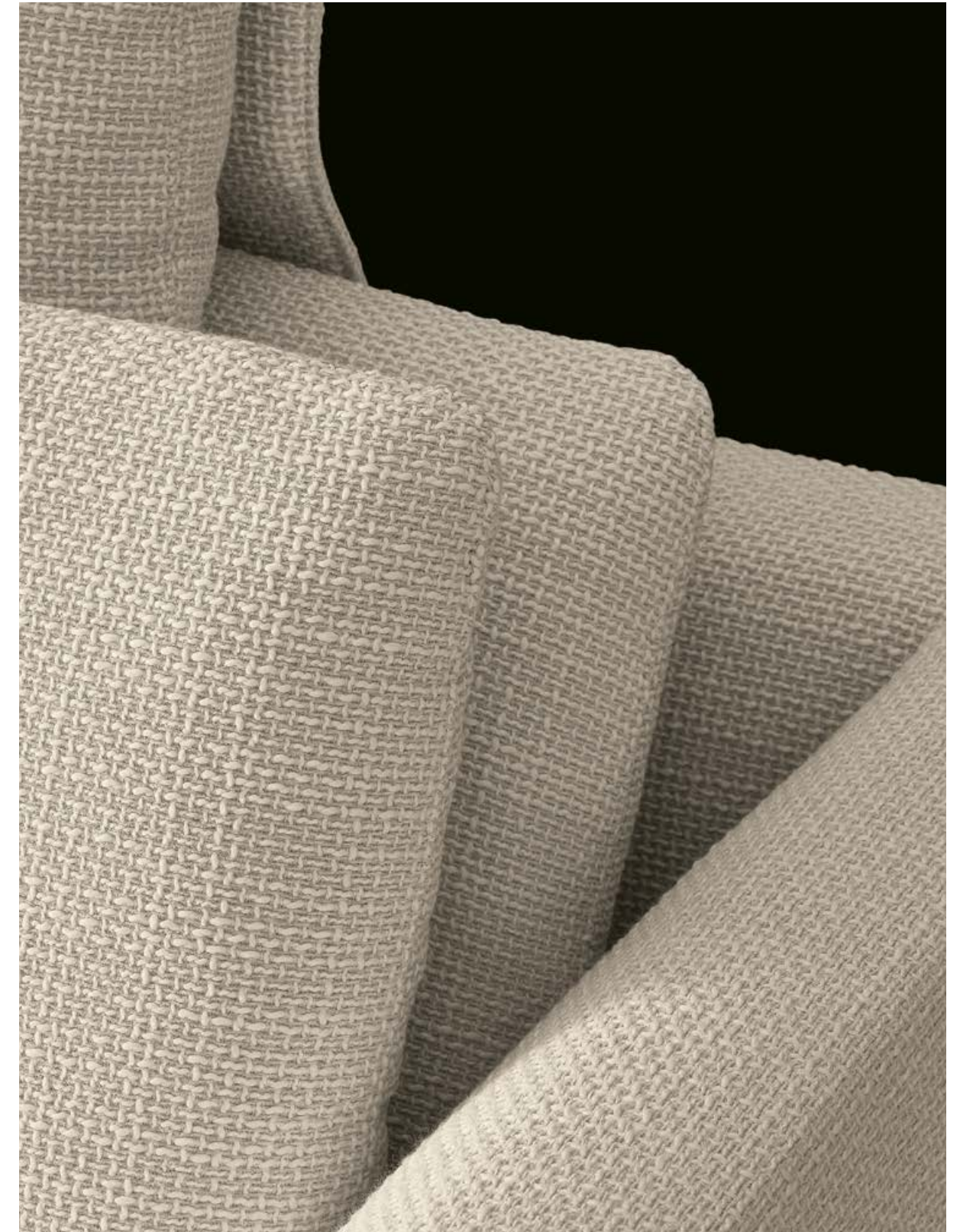

Un dettaglio della cuscinatura doppia. I cuscini a saponetta richiamano la forma di un guanciale.  
A detail of the double stitch. The round cushion recalls the shape of a pillow.





Il bracciolo si caratterizza per il rivestimento continuo con cucitura ribattuta.  
Morbido e voluminoso, è perfetto per i momenti di relax.  
The armrest is characterized by the continuous cover with felled seam.  
Soft and voluminous, it is perfect for the relax moments.

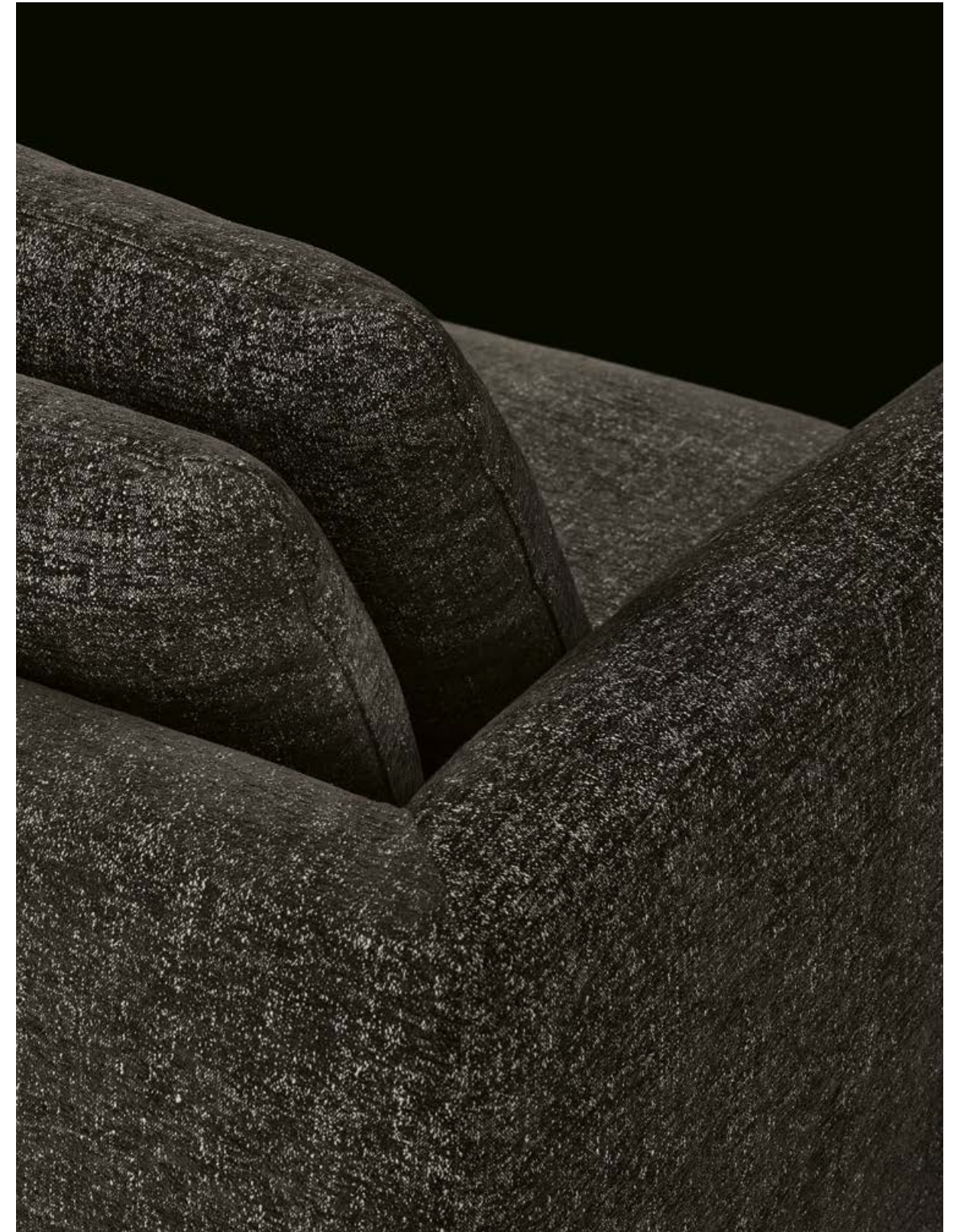

Nella cuscineria doppia, i cuscini possono essere semplicemente appoggiati l'uno sull'altro oppure uniti da una zip.  
In the double stitch, the cushions can be placed one on the other or can be zipped together.

pp. 33,34-35,36,37

Divano Bristol con cuscineria comfort, rivestimento sfoderabile in tessuto Sheffield 01 pepe, cuscini poggiatesta in tessuto Dundee 01 pepe e cuscini opzionali in tessuto Norwich 01 bianco. Bracciolo fisso con struttura in brown nickel lucido.

pp. 38-39, 40, 41

Divano Bristol con cuscineria comfort, rivestimento sfoderabile in tessuto Kitami 04 sabbia, cuscini poggiatesta in velluto Glasgow 03 carbone e cuscini opzionali in tessuto Lero 01 écru.

pp. 42-43, 44, 45

Divano Bristol con cuscineria singola, rivestimento sfoderabile in pelle Nabuk 08 prussia, cuscini opzionali in tessuto Sendai 05 navy e in pelle Nabuk 08 prussia, piedini opzionali in brown nickel lucido.

pp. 46-47, 48, 49

Divano Bristol con cuscineria doppia e poggiatesta, rivestimento sfoderabile in tessuto Indra 01 arena, cuscini opzionali in tessuto Sendai 03 fango e in velluto Persia 1404 carbone, piedini opzionali in brown nickel lucido.

pp. 50-51, 52, 53

Divano Bristol con cuscineria doppia e poggiatesta, rivestimento sfoderabile in tessuto Olimpia 111 castagna, cuscini opzionali in velluto Persia 1404 carbone, piedini opzionali in brown nickel lucido.

pp. 33,34-35,36,37

Bristol sofa with backrest cushion comfort, removable cover in fabric Sheffield 01 pepe, lower back cushions in fabric Dundee 01 pepe and optional cushions in fabric Norwich 01 bianco. Fixed armrest with structure in glossy brown nickel.

pp. 38-39, 40, 41

Bristol sofa with backrest cushion comfort, removable cover in fabric Kitami 04 sabbia, lower back cushions in velvet Glasgow 03 carbone and optional cushions in fabric Lero 01 ecru.

pp. 42-43, 44, 45

Bristol sofa with single backrest cushion, removable cover in leather Nabuk 08 prussia, optional cushions in fabric Sendai 05 navy and in leather Nabuk 08 prussia, optional feet in glossy brown nickel.

pp. 46-47, 48, 49

Bristol sofa with double backrest cushion and headrest, removable cover in fabric Indra 01 arena, optional cushions in fabric Sendai 03 fango and in velvet Persia 1404 carbone, optional feet in glossy brown nickel.

pp. 50-51, 52, 53

Bristol sofa with double backrest cushion and headrest, removable cover in fabric Olimpia 111 castagna, optional cushions in velvet Persia 1404 carbone, optional feet in glossy brown nickel.











Qui, nelle pagine precedenti e nella successiva: divano Bristol con cuscineria singola, rivestimento sfoderabile in tessuto Naxos 17 corda con cuscini in tessuto Zante 10 nero. Poltrona Jane in velluto sfoderabile Persia 54 prussia e basamento in olmo nero. Tavolino Home Hotel in olmo nero. Tavolino Baba in metallo verniciato oro lucido e piano in vetro oro. Pouf Henry in olmo nero e seduta non sfoderabile in velluto Persia 1404 carbone. Tappeto Frame carbone.

Here, previous pages and following page: Bristol sofa with single backrest cushion, removable cover in fabric Naxos 17 corda with cushions in fabric Zante 10 nero. Jane armchair in removable velvet Persia 54 prussia and base in black elm. Home Hotel coffee table in black elm. Baba coffee table in glossy gold painted metal and top in gold glass. Henry pouf in black elm with seat in non-removable velvet Persia 1404 carbone. Carpet Frame carbone.



## BRISTOL

Design Jean-Marie Massaud

### Bristol divano

Cuscineria singola, rivestimento in tessuto sfoderabile Naxos 17 corda, cuscini opzionali tessuto sfoderabile Zante 10 nero e Naxos 17 corda, piedini arretrati in materiale plastico.

### Home Hotel tavolino

Struttura e piano in olmo nero.  
1400x1400 h 340

### Baba tavolino

Struttura metallo verniciato oro lucido, piano in vetro oro.  
Ø 500 h 540

### Henry pouf

Struttura olmo nero, seduta non sfoderabile velluto Persia 1404 carbone.  
Ø 450 h 450

### Jane poltrone

Velluto sfoderabile Persia 54 prussia, basamento olmo nero.  
l 670 p 700 h 750

### Bristol sofa

Single backrest cushion, cover in removable fabric Naxos 17 corda, optional cushions in removable fabric Zante 10 nero and Naxos 17 corda, invisible feet in plastic material.

### Home Hotel coffee table

Structure and top in black elm.  
55"x55" h 13 1/2"

### Baba coffee table

Structure glossy gold painted metal, top in gold glass.  
Ø 19 3/4" h 21 1/4"

### Henry pouf

Structure black elm, seat in non-removable velvet Persia 1404 carbone.  
Ø 17 3/4" h 17 3/4"

### Jane armchairs

Removable velvet Persia 54 prussia, base black elm.  
w 26 1/2" d 27 1/2" h 29 1/2"

### Bristol divano Bristol sofa

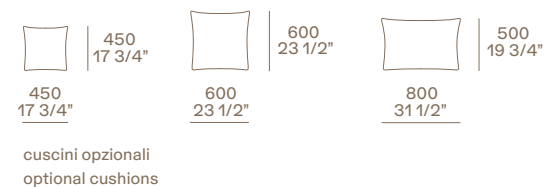
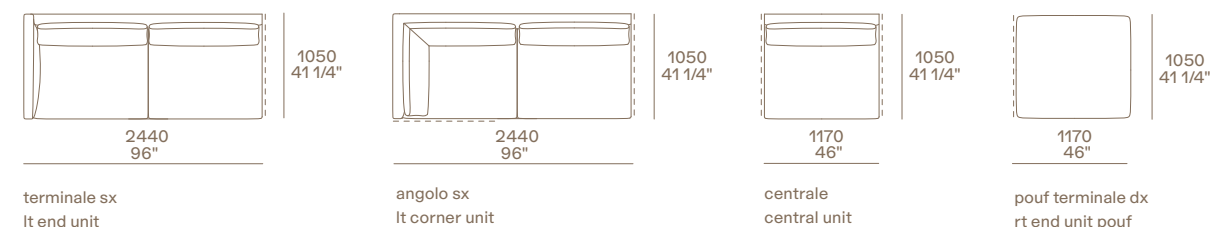
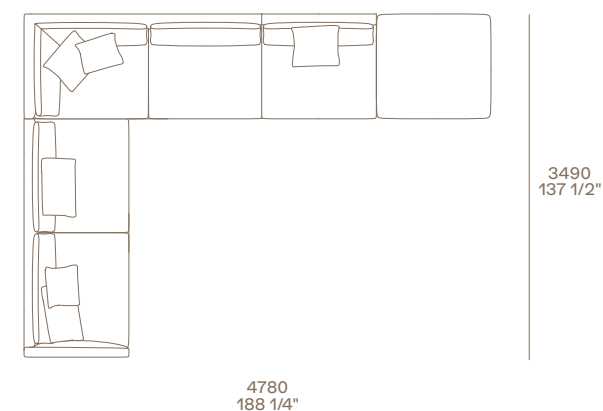

### Home Hotel tavolino Home Hotel coffee table

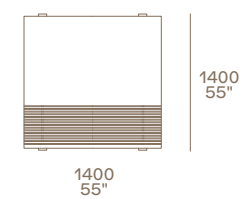

### Baba tavolino Baba coffee table



### Henry pouf Henry pouf



### Jane poltrona Jane armchair











Qui e nelle pagine precedenti: divano Bristol con cuscinata doppia, rivestimento sfoderabile in tessuto Rabat 412 cemento, cuscini in velluto Persia 1404 carbone e 1403 ocra. Pouf Bristol rivestimento sfoderabile in velluto Persia 1404 carbone. Madia e tavolini Bristol in olmo nero, piedini in brown nickel opaco. Tavolino Baba in brown nickel opaco e piano in marmo emperador dark levigato. Poltrone Mad Chair in velluto sfoderabile Persia 1404 carbone, gambe in olmo nero. Composizione Wall System laccato lucido moka e olmo nero, ante scorrevoli Bold in cuoio 02 nero. A sinistra: dettaglio del bracciolo fisso opzionale per elementi terminali.

Here and previous pages: Bristol sofa with double backrest cushion, removable cover in fabric Rabat 412 cemento, cushions in velvet Persia 1404 carbone and 1403 ocra. Bristol pouf with removable cover in velvet Persia 1404 carbone. Sideboard and coffee table Bristol in black elm, mat brown nickel feet. Baba coffee table in mat brown nickel and top in mat marble emperador dark. Mad Chair armchairs in removable velvet Persia 1404 carbone, legs in black elm. Wall Sytem bookcase in moka glossy lacquer and black elm, Bold sliding doors in hide 02 nero. Left: close up of the optional fixed arm for end units.

## BRISTOL

Design Jean-Marie Massaud

### Bristol divano

Cuscinatura doppia, rivestimento in tessuto sfoderabile Rabat 412 cemento, cuscini opzionali velluto sfoderabile Persia 1404 carbone e 1403 ocra, piedini arretrati in materiale plastico. Bracciolo fisso con struttura brown nickel opaco. Tavolino retrodivano Bristol System h 430, struttura olmo nero, contenitori laccato opaco moka, inserti e piedini brown nickel opaco.

### Bristol pouf

Velluto sfoderabile Persia 1404 carbone, piedini arretrati in materiale plastico.

### Bristol tavolino

Struttura olmo nero, inserti e piedini brown nickel opaco.  
1400x1400 h 330

### Baba tavolino

Struttura brown nickel opaco, piano in marmo emperador dark levigato.  
Ø 500 h 540

### Mad Chair poltrone

Velluto sfoderabile Persia 1404 carbone, gambe in olmo nero.  
l 810 p 770 h 700

### Bristol sofa

Double backrest cushion, cover in removable fabric Rabat 412 cemento, optional cushions in removable velvet Persia 1404 carbone and 1403 ocra, invisible feet in plastic material. Fixed arm with structure mat brown nickel. Bristol System coffee table at the back of the sofa h 17", structure black elm, storage units mat lacquer moka, inlays and feet mat brown nickel.

### Bristol poufs

Removable velvet Persia 1404 carbone, invisible feet in plastic material.

### Bristol coffee table

Structure black elm, inlays and feet mat brown nickel.  
55"x55" h 13"

### Baba coffee table

Structure mat brown nickel, top in mat marble emperador dark.  
Ø 19 3/4" h 21 1/4"

### Mad Chair armchairs

Removable velvet Persia 1404 carbone, legs in black elm.  
w 32" d 30 1/4" h 27 1/2"

### Bristol divano Bristol sofa

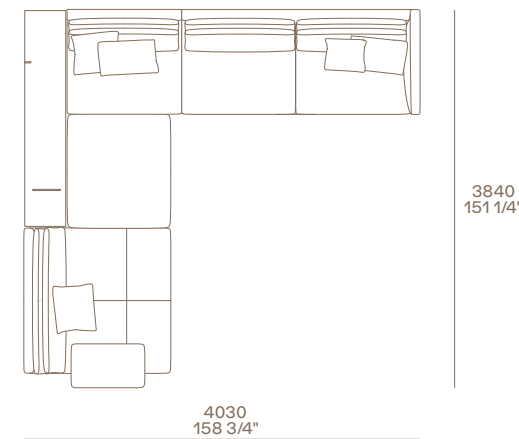

### Bristol pouf Bristol poufs

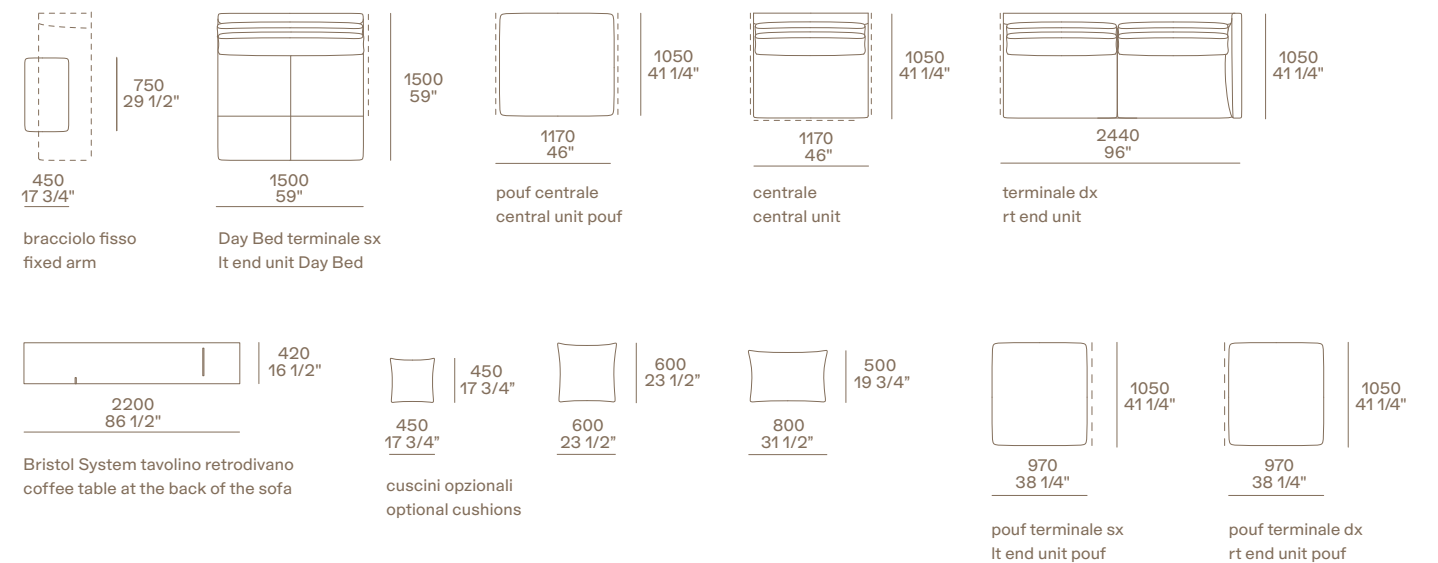
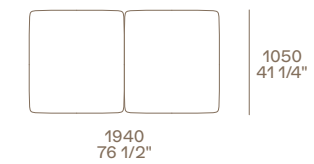

### Bristol tavolino Bristol coffee table

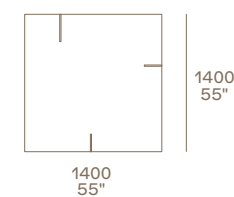

### Baba tavolino Baba coffee table



### Mad Chair poltrona Mad Chair armchair













Qui e nelle pagine precedenti: divano Bristol con cuscinata libera in pelle sfoderabile Nabuk 02 tortora, cuscini in tessuto Lima 63 nero e pelle Nabuk 02 tortora. Tavolini Bristol laterale e centrale in rovere spessart, inserti e piedini in brown nickel opaco. Libreria Wall System in rovere spessart. Madia Pandora laccato lucido visone. Poltrone Ipanema in rovere spessart, seduta con cinghie in cuoio 03 grigio scuro e cuscino in tessuto sfoderabile Siviglia 04 grafite.

Here and previous pages: Bristol sofa with loose cushions in removable leather Nabuk 02 tortora, cushions in fabric Lima 63 nero and leather Nabuk 02 tortora. Central and side Bristol coffee tables in spessart oak, inlays and feet in mat brown nickel. Wall System bookcase in spessart oak. Visone glossy lacquered Pandora sideboard. Ipanema armchairs in spessart oak, seat with belts in hide 03 grigio scuro and cushion in removable fabric Siviglia 04 grafite.

## BRISTOL

Design Jean-Marie Massaud

### Bristol divano

Cuscineria libera, rivestimento in pelle sfoderabile Nabuk 02 tortora, cuscini tessuto sfoderabile Lima 63 nero e pelle sfoderabile Nabuk 02 tortora, piedini arretrati in materiale plastico. Tavolino retrodivano Bristol System h 430, struttura rovere spessart, inserti e piedini brown nickel opaco.

### Bristol tavolino

Struttura rovere spessart, inserti e piedini brown nickel opaco. 1400x1400 h 330

### Ipanema poltrone

Struttura rovere spessart, seduta con cinghie in cuoio 03 grigio scuro e cuscino in tessuto sfoderabile Siviglia 04 grafite. l 810 p 900 h 815

### Bristol sofa

Loose cushions, cover in removable leather Nabuk 02 tortora, cushions in removable fabric Lima 63 nero and removable leather Nabuk 02 tortora, invisible feet in plastic material. Bristol System coffee table at the back of the sofa h 17", structure spessart oak, inlays and feet mat brown nickel.

### Bristol coffee table

Structure spessart oak, inlays and feet mat brown nickel. 55"x55" h 13"

### Ipanema armchairs

Structure spessart oak, seat with belts in hide 03 grigio scuro and cushion in removable fabric Siviglia 04 grafite. w 32" d 35 1/2" h 32"

### Bristol divano Bristol sofa

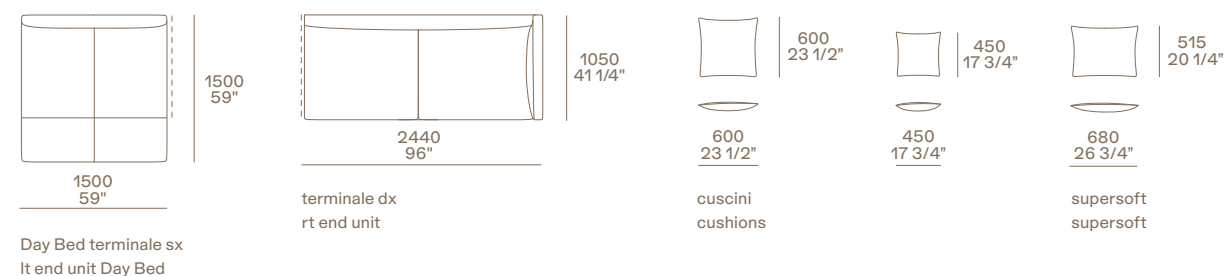
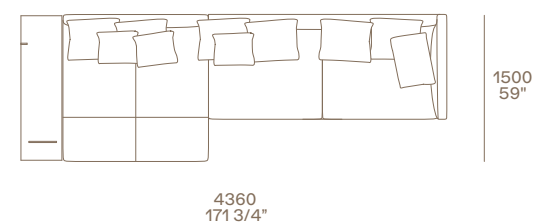

Bristol System tavolino retrodivano  
coffee table at the back of the sofa

### Bristol tavolino Bristol coffee table

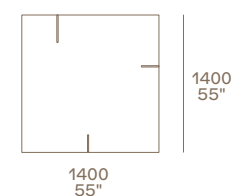

### Ipanema poltrona Ipanema armchair

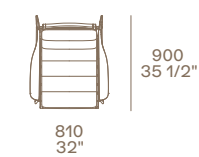

COMPOSITIONS

COMPOSITION 01	90
COMPOSITION 02	94
COMPOSITION 03	98
COMPOSITION 04	102
COMPOSITION 05	106
COMPOSITION 06	110



COMPOSITION 01

**1 Bristol divani**

Cuscineria comfort, rivestimento in tessuto sfoderabile Brest 02 salvia, cuscini poggiatesta in velluto sfoderabile Tebe 07 oliva, cuscini opzionali in tessuto sfoderabile Brest 02 salvia, piedini opzionali in brown nickel opaco.  
A 4260x3095 - B 2995x3000

**1 Bristol sofas**

Backrest cushion comfort, cover in removable fabric Brest 02 salvia, lower back cushions in removable velvet Tebe 07 oliva, optional cushions in removable fabric Brest 02 salvia, optional feet mat brown nickel.  
A 167 3/4"x121 3/4" - B 117 3/4"x118"

**2 Creek tavolini**

Struttura in brown nickel satinato. Piano in olmo nero, piano inferiore laccato lucido moka, Ø 420 h 520. Piano in marmo zecevo levigato, piano inferiore in olmo nero, 700x1200 h 310 - 1200x1200 h 310

**2 Creek coffee tables**

Structure brushed brown nickel. Top black elm, lower shelf glossy lacquer moka, Ø 16 1/2" h 20 1/2". Top in mat marble zecevo, lower shelf black elm, 27 1/2"x47 1/4" h 12 1/4" - 47 1/4"x47 1/4" h 12 1/4"

**3 Mad Joker poltrona**

Pelle non sfoderabile Nabuk 10 oliva, basamento girevole in brown nickel lucido. 1800 p 800 h 1085

**3 Mad Joker armchair**

Non-removable leather Nabuk 10 oliva, swivel base glossy brown nickel. w 31 1/2" d 31 1/2" h 42 3/4"

**4 Dama tavolino**

Massello di noce canaletto. Ø 340 h 460

**4 Dama coffee table**

Solid walnut canaletto. Ø 13 1/2" h 18"

**5 Plain tappeto**

Colore naturale. Dimensioni su misura 7500x4700

**5 Plain carpet**

Colour natural. Customized sizes 295 1/4"x185"

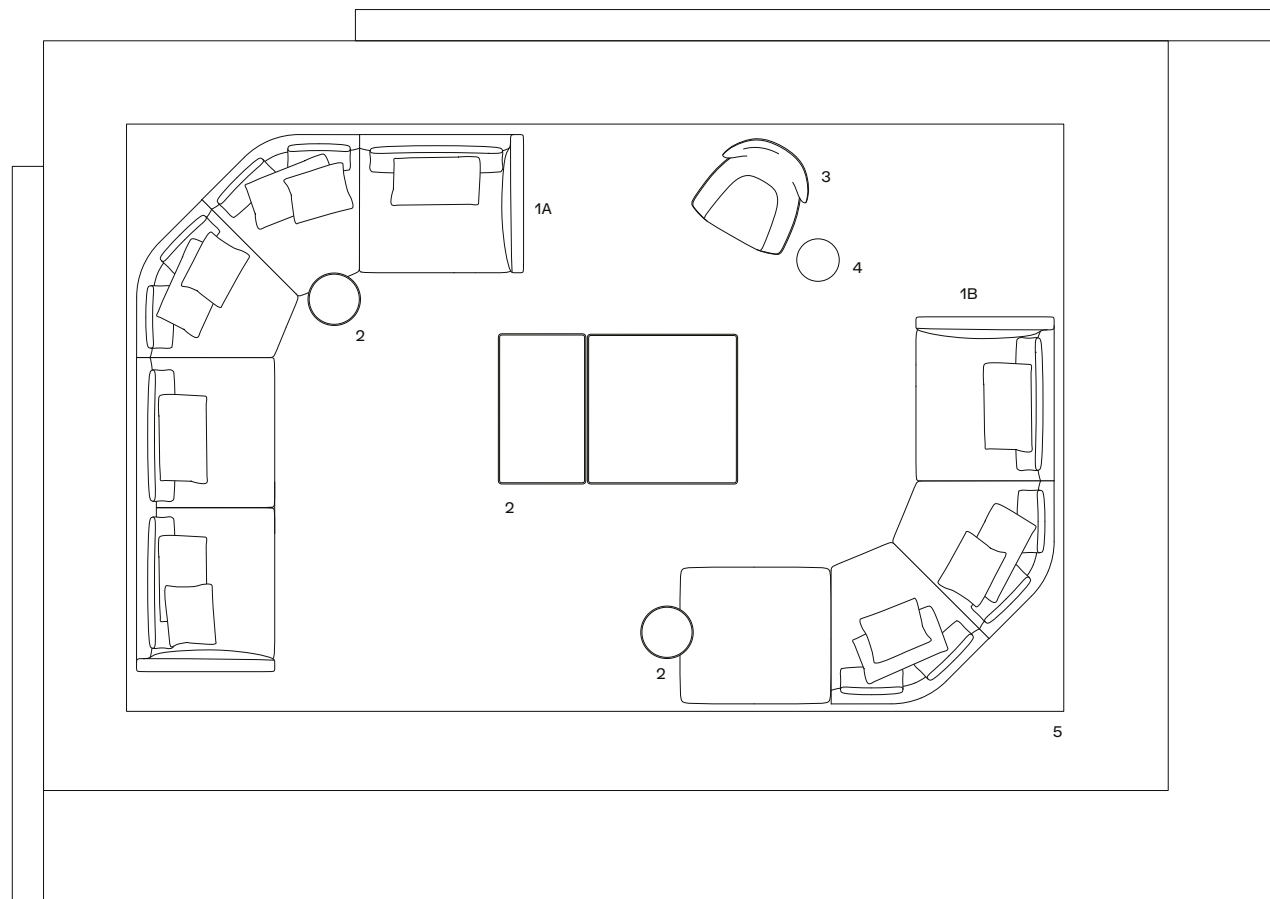

Display 54 mq-sqm

**Bristol composizione A**  
Bristol composition A

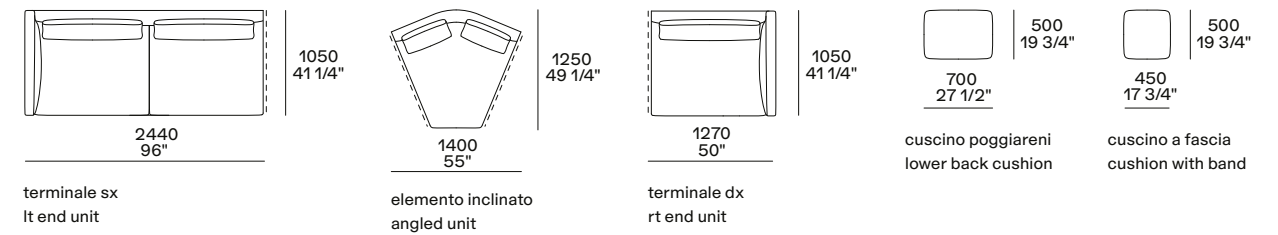

**Bristol composizione B**  
Bristol composition B

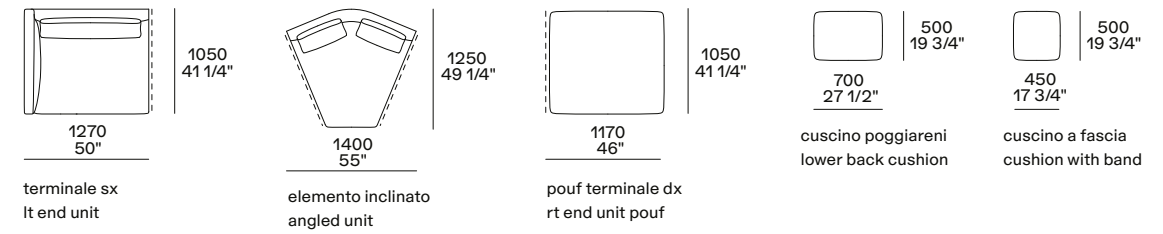

**Creek tavolini**  
Creek coffee tables

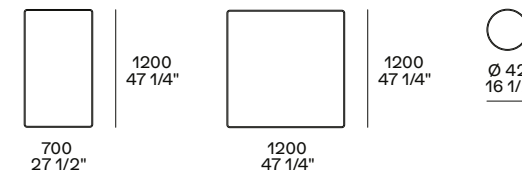

**Mad Joker poltrona**  
Mad Joker armchair

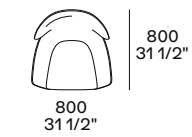

**Dama tavolino**  
Dama coffee table



brest 02 salvia  
tessuto - fabric

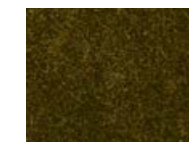

tebe 07 oliva  
velluto - velvet



brown nickel opaco  
mat brown nickel

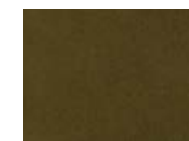

nabuk 10 oliva  
pelle - leather

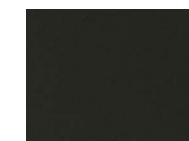

brown nickel lucido  
glossy brown nickel



zecevo  
marmo levigato  
mat marble

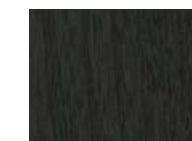

olmo nero  
black elm



49 moka  
laccato lucido  
glossy lacquer

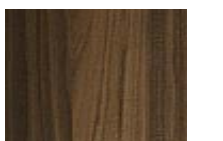

massello noce canaletto  
solid walnut canaletto





## COMPOSITION 02

### 1 Bristol divani e tavolini

Cuscineria comfort, rivestimento in tessuto sfoderabile Nayoro 02 sabbia, cuscini poggiatesta tessuto sfoderabile Agadir 03 pepe, cuscini opzionali tessuto sfoderabile Nancy 101 carbone, piedini opzionali e inserti brown nickel lucido, tavolino retrodivano in olmo nero.  
A 4105x2500 - B 3970x2495

### 2 Westside tavolini

Struttura olmo nero. Piano in marmo sahara noir levigato finitura poliesteri.  
1200x1200 - 1200x600 h 310

### 3 Mad Chair poltrone

Velluto sfoderabile Persia 2002 bruciato, basamento girevole brown nickel lucido.  
l 810 p 770 h 700

### 4 Flute tavolini

Base cromo nero, piano in vetro riflettente blu.  
Ø 500 h 502 - 600

### 5 Relief tappeto

Colore cammello.  
Dimensioni su misura 6400x4600

### 1 Bristol sofa and coffee tables

Backrest cushion comfort, cover in removable fabric Nayoro 02 sabbia, lower back cushions in removable fabric Agadir 03 pepe, optional cushions in removable fabric Nancy 101 carbone, optional feet and inlays glossy brown nickel, coffee table at the back of the sofa in black elm.  
A 161 1/2"x98 1/2" - B 156 1/4"x98 1/4"

### 2 Westside coffee tables

Structure black elm. Top in mat marble sahara noir polyester finish.  
47 1/4"x47 1/4" - 47 1/4"x23 1/2" h 12 1/4"

### 3 Mad Chair armchairs

Removable velvet Persia 2002 bruciato, swivel base glossy brown nickel.  
w 32" d 30 1/4" h 27 1/2"

### 4 Flute coffee tables

Base in black chrome, top in blu reflecting glass.  
Ø 19 3/4" h 19 3/4" - 23 1/2"

### 5 Relief carpet

Colour cammello.  
Customized sizes 252"x181"

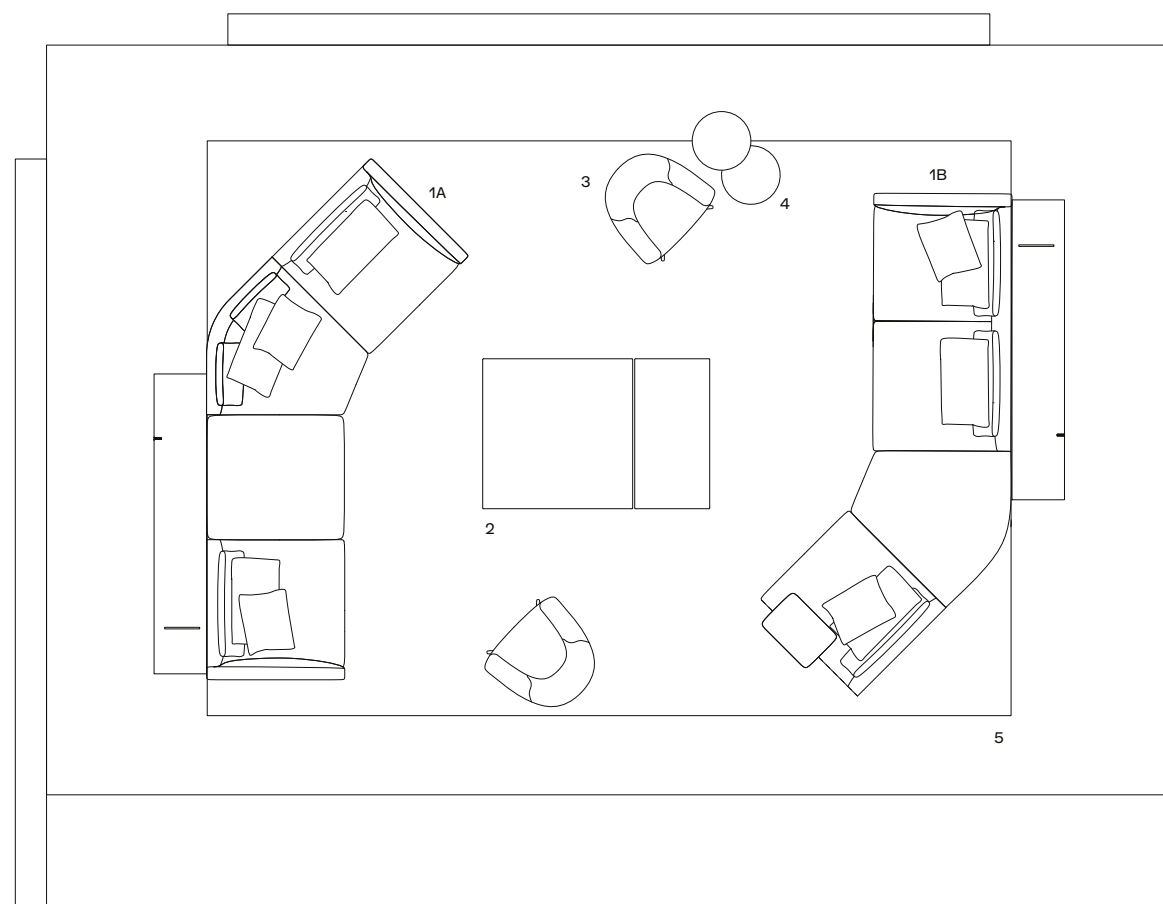

Display 54 mq-sqm

### Bristol composizione A Bristol composition A

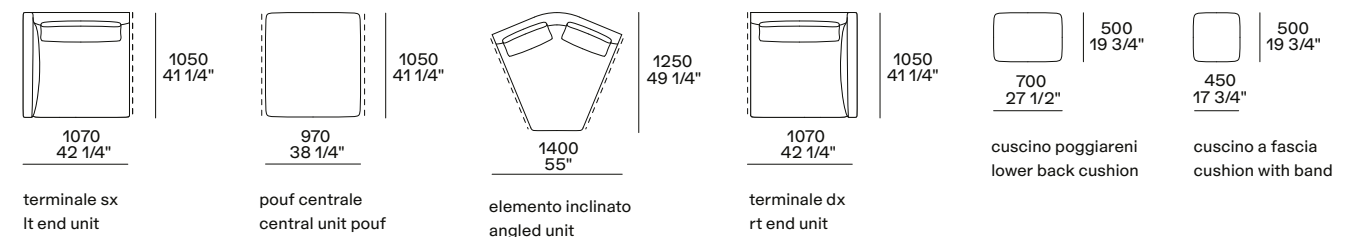

### Bristol composizione B Bristol composition B

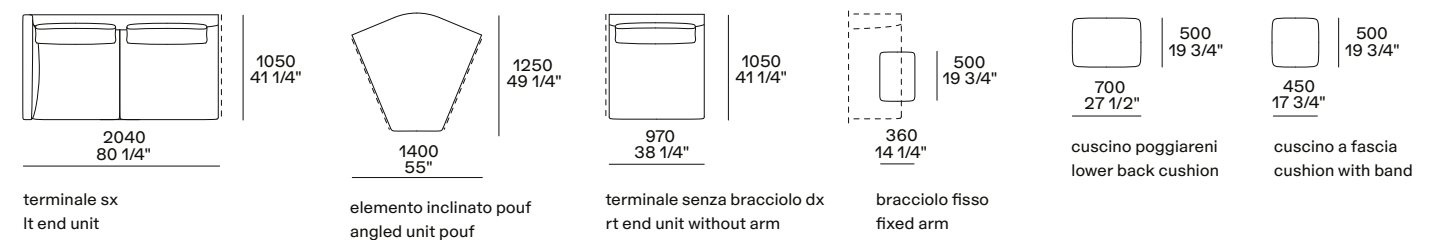

### Bristol System tavolino Bristol System coffee table

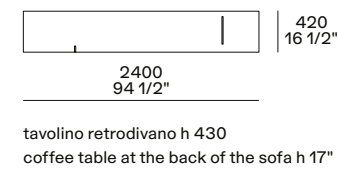

tavolino retrodivano h 430  
coffee table at the back of the sofa h 17"

### Westside tavolini Westside coffee tables

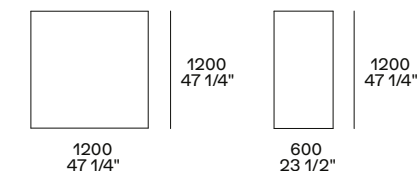

### Mad Chair poltrona Mad Chair armchair

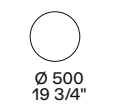
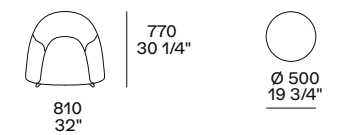

nayoro 02 sabbia  
tessuto - fabric



agadir 03 pepe  
tessuto - fabric



nancy 101 carbone  
tessuto - fabric

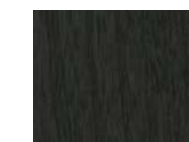

olmo nero  
black elm

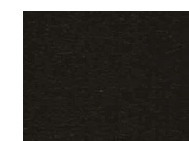

persia 2002 bruciato  
velluto - velvet

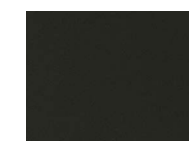

brown nickel lucido  
glossy brown nickel



sahara noir  
marmo levigato  
mat marble



5010 blu  
vetro riflettente  
reflecting glass



cromo nero  
black chrome



## COMPOSITION 03

### 1 Bristol divano e tavolino

Cuscineria comfort, rivestimento in tessuto sfoderabile Norwich 02 sabbia, cuscini poggiatesta in tessuto sfoderabile Sheffield 02 sabbia, cuscini opzionali in tessuto sfoderabile Dundee 02 sabbia, piedini opzionali e inserti brown nickel lucido, tavolino retrodivano laccato opaco visone. Composizione 4345x4710

### 2 Mondrian tavolini

Strutture verniciate brown nickel opaco. Piani in marmo verde lepanto levigato 1400x700 h 290; olmo nero Ø 1000 h 380; laccato lucido visone Ø 550 h 480

### 3 Jane poltrone

Pelle non sfoderabile Silk 13 oliva, basamento olmo nero. l 670 p 700 h 750

### 4 Dama tavolino

Massello di noce canaletto. Ø 340 h 460

### 5 Plain tappeto

Colore tortora. Dimensioni su misura 6000x4600

### 1 Bristol sofa and coffee table

Backrest cushion comfort, cover in removable fabric Norwich 02 sabbia, lower back cushions in removable fabric Sheffield 02 sabbia, optional cushions in removable fabric Dundee 02 sabbia, optional feet and inlays glossy brown nickel, coffee table at the back of the sofa mat lacquer visone. Composition 171"x185 1/2"

### 2 Mondrian coffee tables

Structures painted mat brown nickel. Tops in mat marble verde lepanto 55"x27 1/2" h 11 1/2"; black elm Ø 39 1/4" h 15"; glossy lacquer visone Ø 21 3/4" h 19"

### 3 Jane armchairs

Non-removable leather Silk 13 oliva, base black elm. w 26 1/2" d 27 1/2" h 29 1/2"

### 4 Dama coffee table

Solid walnut canaletto. Ø 13 1/2" h 18"

### 5 Plain carpet

Colour tortora. Customized sizes 236 1/4"x181"

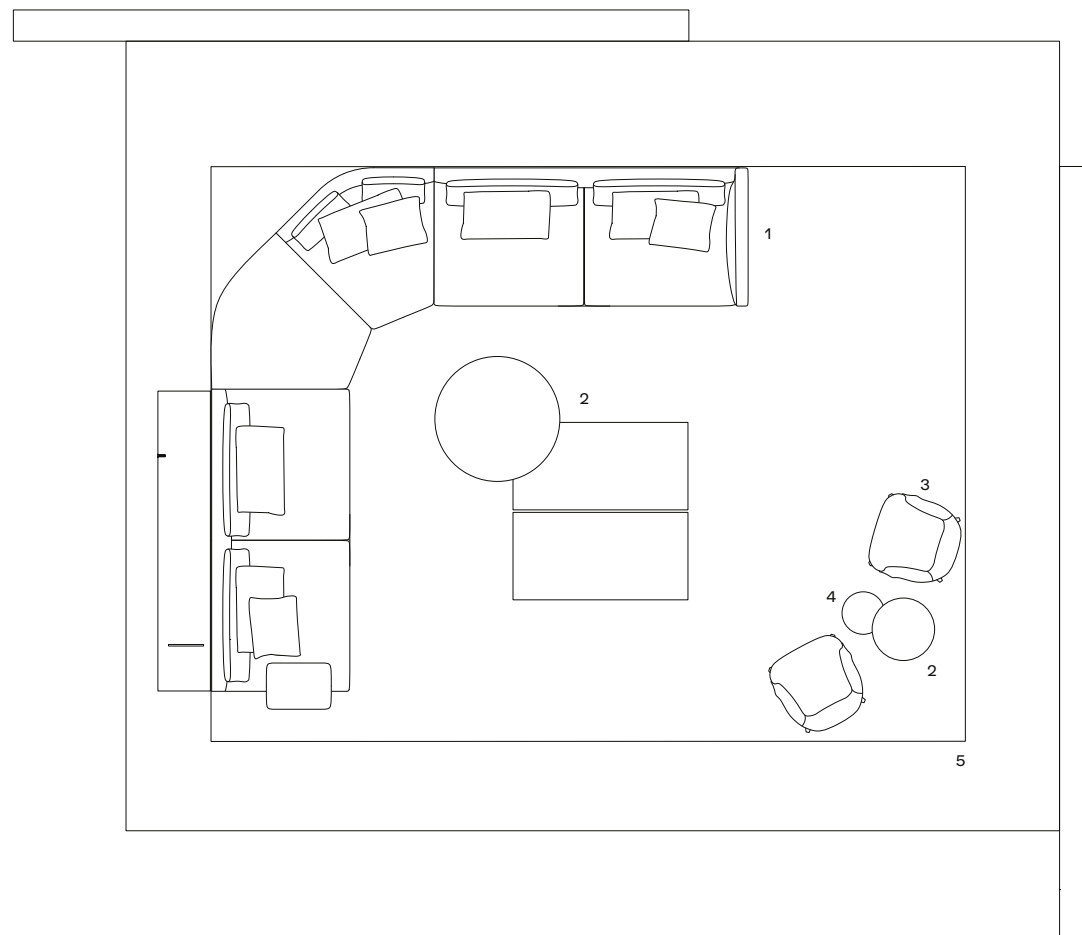

Display 50 mq-sqm

### Bristol divano Bristol sofa

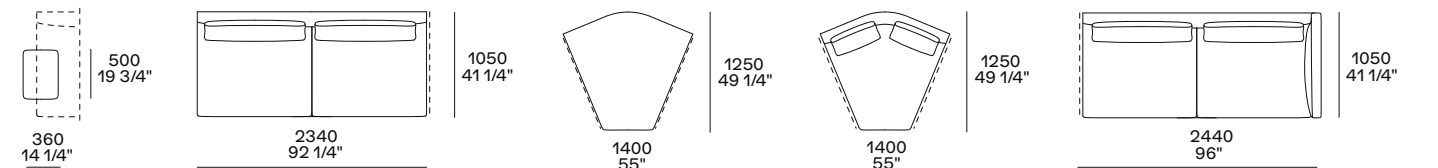

bracciolo fisso  
fixed arm

terminale senza bracciolo sx  
lt end unit without arm

elemento inclinato pouf  
angled unit pouf

elemento inclinato  
angled unit

terminale dx  
rt end unit

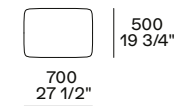

cuscino poggiatesta  
lower back cushion

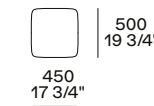

cuscino a fascia  
cushion with band

### Bristol System tavolino Bristol System coffee table

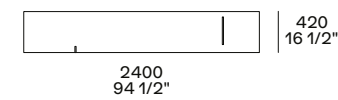

tavolino retrodivano h 430  
coffee table at the back of the sofa h 17"

### Mondrian tavolini Mondrian coffee tables

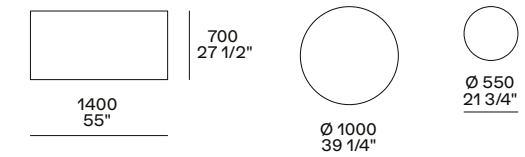

### Jane poltrona Jane armchair

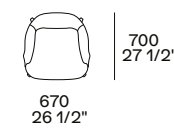

### Dama tavolino Dama coffee table

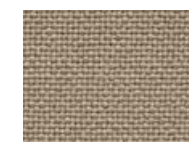

norwich 02 sabbia  
tessuto - fabric

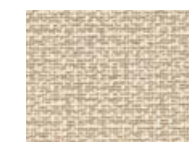

sheffield 02 sabbia  
tessuto - fabric

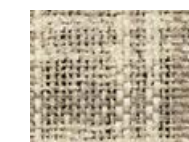

dundee 02 sabbia  
tessuto - fabric



48 visone  
laccato opaco  
mat lacquer

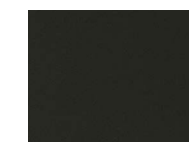

brown nickel lucido  
glossy brown nickel

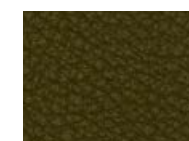

silk 13 oliva  
pelle - leather



olmo nero  
black elm



brown nickel opaco  
mat brown nickel



verde lepanto  
marmo levigato  
mat marble



48 visone  
laccato lucido  
glossy lacquer

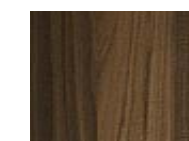

massello noce canaletto  
solid walnut canaletto



## COMPOSITION 04

### 1 Bristol divano

Cuscineria comfort, rivestimento in tessuto sfoderabile Kitami 04 sabbia, cuscini poggiatesta tessuto sfoderabile Lero 01 écru, cuscini opzionali velluto sfoderabile Glasgow 03 carbone, piedini opzionali brown nickel lucido. Composizione 5220x2690

### 1 Bristol sofa

Backrest cushion comfort, cover in removable fabric Kitami 04 sabbia, lower back cushions in removable fabric Lero 01 écru, optional cushions in removable velvet Glasgow 03 carbone, optional feet glossy brown nickel. Composition 205 1/2"x106"

### 2 Mondrian tavolini

Strutture verniciato brown nickel lucido. Piani in marmo zecevo levigato 1400x700 h 290; olmo nero Ø 1000 h 380; laccato lucido moka Ø 550 h 480

### 2 Mondrian coffee tables

Structures painted glossy brown nickel. Tops in mat marble zecevo 55"x27 1/2" h 11 1/2"; black elm Ø 39 1/4" h 15"; glossy lacquer moka Ø 21 3/4" h 19"

### 3 Stanford poltrone

Cuoio non sfoderabile 26 invecchiato, basamento girevole brown nickel lucido. l 705 p 645 h 710

### 3 Stanford armchairs

Non-removable hide 26 invecchiato, swivel base glossy brown nickel. w 27 3/4" d 25 1/2" h 28"

### 4 Dama tavolino

Massello di noce canaletto. Ø 340 h 460

### 4 Dama coffee table

Solid walnut canaletto. Ø 13 1/2" h 18"

### 5 Cannelé tappeto

Dimensioni su misura 6500x4900

### 5 Cannelé carpet

Customized sizes 256"x193"

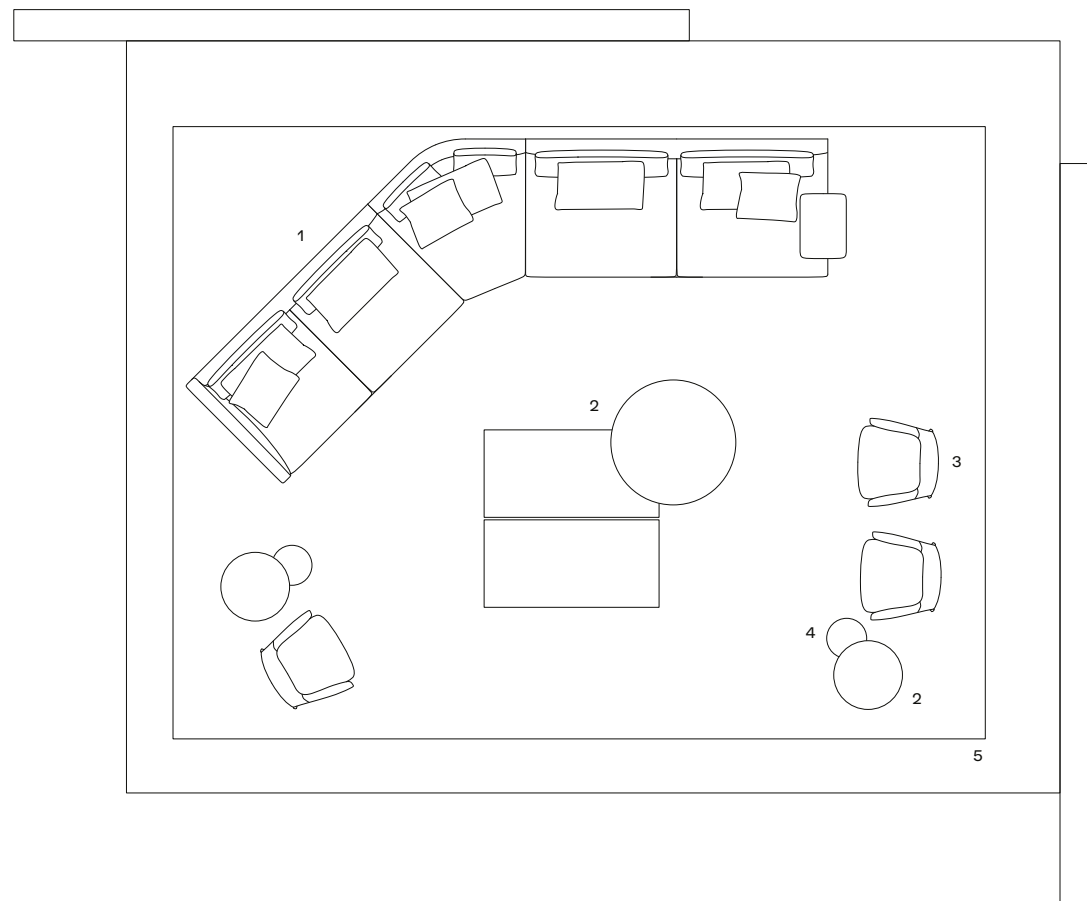

Display 48 mq-sqm

### Bristol divano Bristol sofa

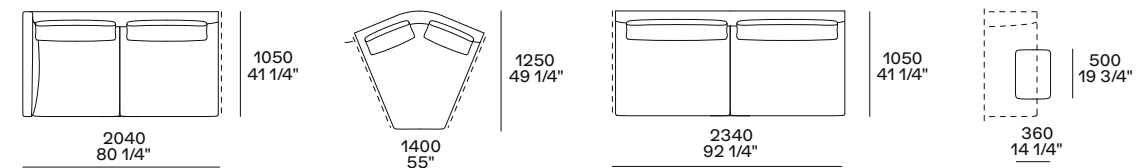

terminale sx  
lt end unit

elemento inclinato  
angled unit

terminale senza bracciolo dx  
rt end unit without arm

bracciolo fisso  
fixed arm

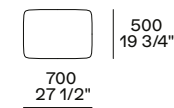

cuscino poggiatesta  
lower back cushion

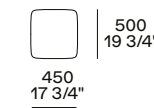

cuscino a fascia  
cushion with band

### Mondrian tavolini Mondrian coffee tables

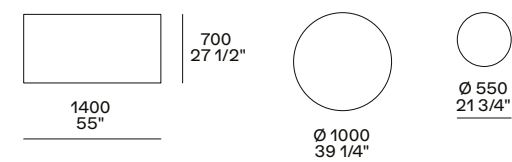

### Stanford poltrona Stanford armchair

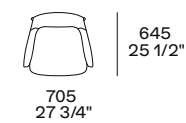

### Dama tavolino Dama coffee table



kitami 04 sabbia  
tessuto - fabric

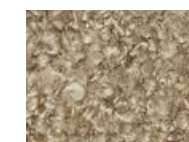

lero 01 écru  
tessuto - fabric



glasgow 03 carbone  
velluto - velvet



26 invecchiato  
cuoio - hide

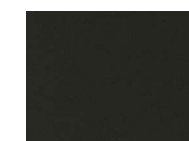

brown nickel lucido  
glossy brown nickel



zecevo  
marmo levigato  
mat marble



olmo nero  
black elm



49 moka  
laccato lucido  
glossy lacquer

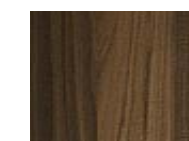

massello noce canaletto  
solid walnut canaletto

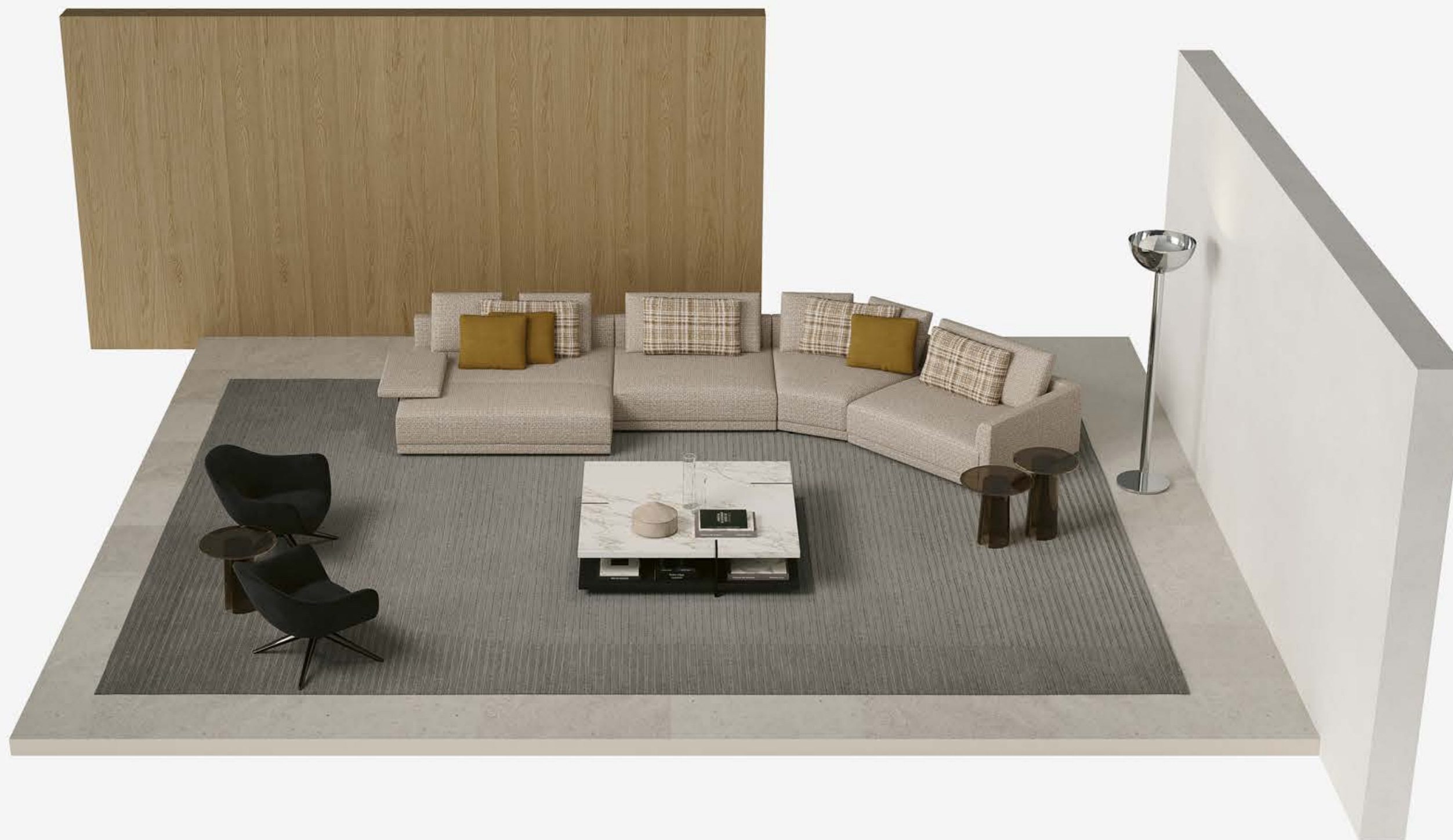

COMPOSITION 05

**1 Bristol divano**  
Cuscineria comfort, rivestimento in tessuto sfoderabile Sheffield 04 bronzo, cuscini poggiatesta tessuto sfoderabile Dundee 04 bronzo, cuscini opzionali tessuto sfoderabile Norwich 04 bronzo, piedini opzionali brown nickel lucido. Composizione 5000x2105

**1 Bristol sofa**  
Backrest cushion comfort, cover in removable fabric Sheffield 04 bronzo, lower back cushions in removable fabric Dundee 04 bronzo, optional cushions in removable fabric Norwich 04 bronzo, optional feet glossy brown nickel. Composition 196 3/4"x82 3/4"

**2 Bristol tavolino**  
Piano in marmo calacatta oro levigato, piano inferiore olmo nero, inserti e piedini brown nickel lucido. 1400x1400 h 330

**2 Bristol coffee table**  
Top in mat marble calacatta oro, lower shelf black elm, inlays and feet glossy brown nickel. 55"x55" h 13"

**3 Mad Chair poltrone**  
Velluto sfoderabile Persia 1404 carbone, basamento girevole brown nickel lucido. l 810 p 770 h 700

**3 Mad Chair armchairs**  
Removable velvet Persia 1404 carbone, swivel base glossy brown nickel. w 32" d 30 1/4" h 27 1/2"

**4 Orbit tavolini**  
Piano e struttura in vetro bronzato, struttura in vetro soffiato. Ø 440 h 550 - Ø 480 h 460

**4 Orbit coffee tables**  
Top and structure in bronzed glass, structure in blown glass. Ø 17 1/4" h 21 3/4" - Ø 19" h 18"

**5 Relief tappeto**  
Colore perla. Dimensioni su misura 6400x4900

**5 Relief carpet**  
Colour perla. Customized sizes 252"x193"

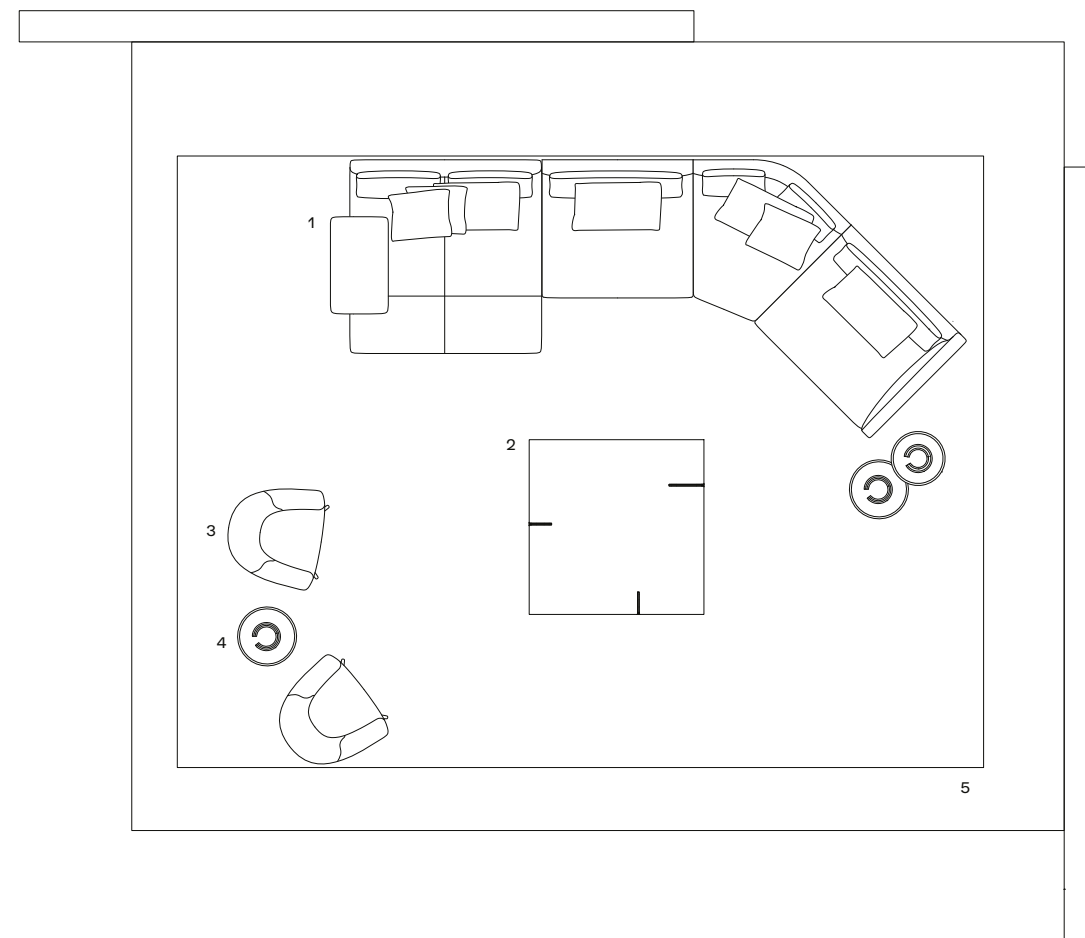

Display 50 mq-sqm

**Bristol divano  
Bristol sofa**

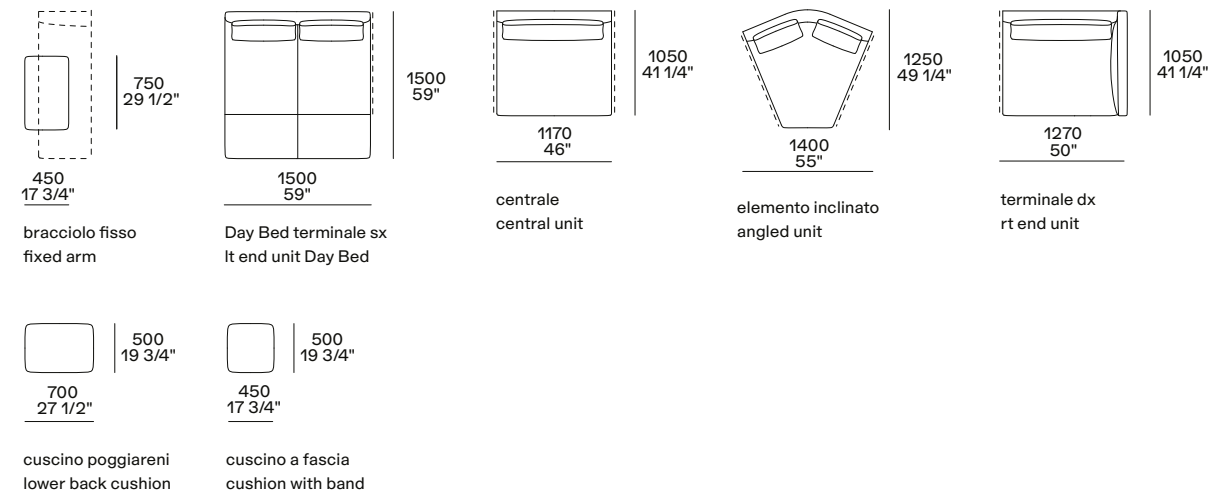

**Bristol tavolino  
Bristol coffee table**

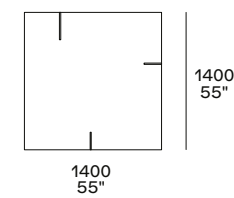

**Mad Chair poltrona  
Mad Chair armchair**

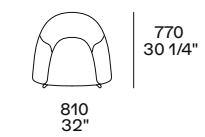

**Orbit tavolini  
Orbit coffee tables**

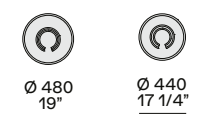

sheffield 04 bronzo tessuto - fabric

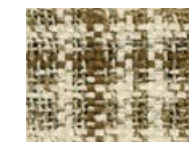

dundee 04 bronzo tessuto - fabric

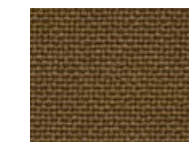

norwich 04 bronzo tessuto - fabric

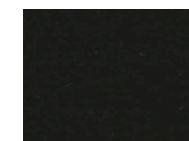

persia 1404 carbone velluto - velvet

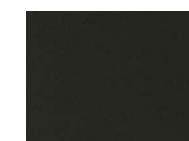

brown nickel lucido glossy brown nickel



calacatta oro marmo levigato mat marble



olmo nero black elm



3051 bronzato vetro - glass





COMPOSITION 06

**1 Bristol divano**

Cuscineria comfort, rivestimento in tessuto sfoderabile Sheffield 01 pepe, cuscini poggiatesta tessuto sfoderabile Dundee 01 pepe, cuscini opzionali tessuto sfoderabile Norwich 01 bianco, piedini opzionali brown nickel opaco. Composizione 4430x3100

**1 Bristol sofa**

Backrest cushion comfort, cover in removable fabric Sheffield 01 pepe, lower back cushions in removable fabric Dundee 01 pepe, optional cushions in removable fabric Norwich 01 bianco, optional feet mat brown nickel. Composition 174 1/2"x122"

**2 Creek tavolini**

Struttura brown nickel satinato. Piano in vetro fumé, piano inferiore olmo nero, 1200x700 h 310. Piano in marmo sahara noir levigato finitura poliester, piano inferiore olmo nero, Ø 420 h 520 - 1200x1200 h 310

**2 Creek coffee tables**

Structure brushed brown nickel. Top in fumé glass, lower shelf black elm, 47 1/4"x27 1/2" h 12 1/4". Top mat marble sahara noir polyester finish, lower shelf black elm, Ø 16 1/2" h 20 1/2" 47 1/4"x47 1/4" h 12 1/4"

**3 Jane poltrone**

Pelle non sfoderabile Silk 03 talpa, basamento brown nickel lucido. l 670 p 700 h 750

**3 Jane armchairs**

Non-removable leather Silk 13 oliva, base brown nickel lucido. w 26 1/2" d 27 1/2" h 29 1/2"

**4 Orbit tavolini**

Piano e struttura in vetro bronzato, struttura in vetro soffiato. Ø 440 h 550 - Ø 480 h 460

**4 Orbit coffee tables**

Top and structure in bronzed glass, structure in blown glass. Ø 17 1/4" h 21 3/4" - Ø 19" h 18"

**5 Frame tappeto**

Colore carbone. Dimensioni su misura 6700x4700

**5 Frame carpet**

Colour carbone. Customized sizes 263 3/4"x185"

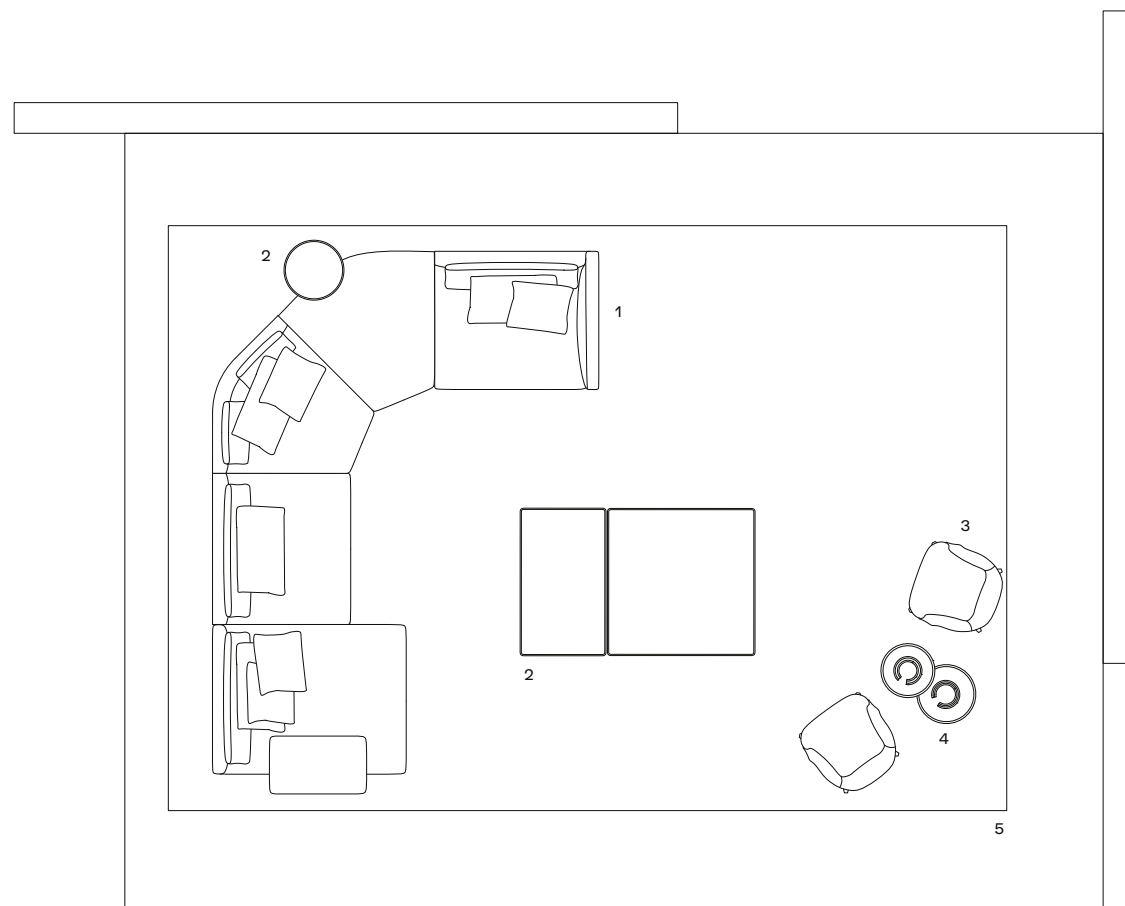

Display 53 mq-sqm

**Bristol divano  
Bristol sofa**

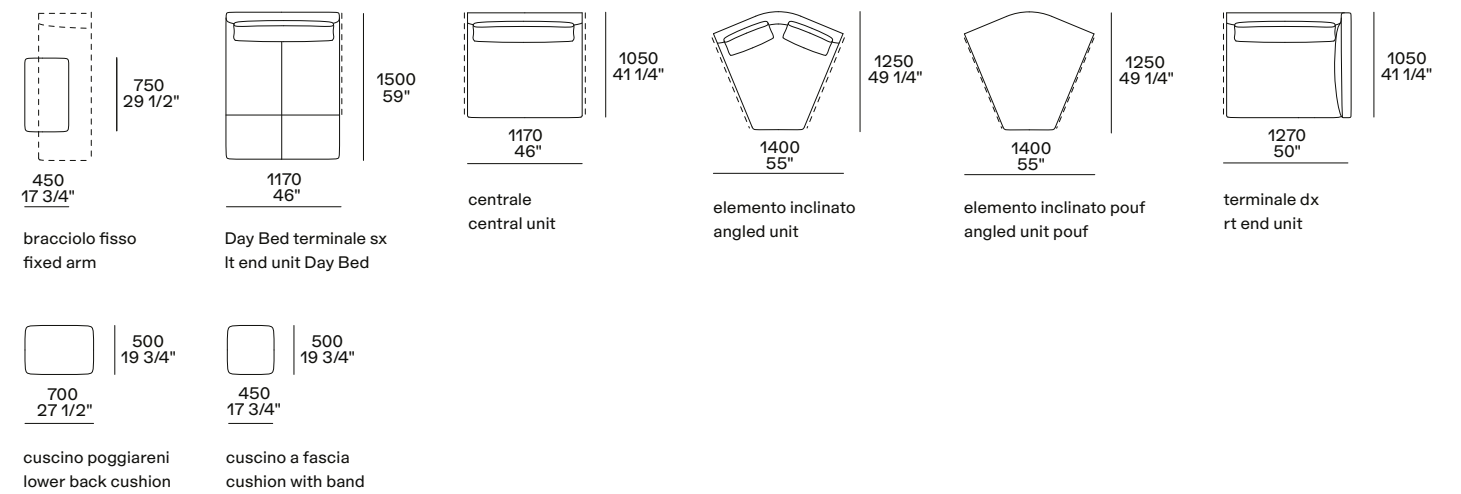

**Creek tavolini  
Creek coffee tables**

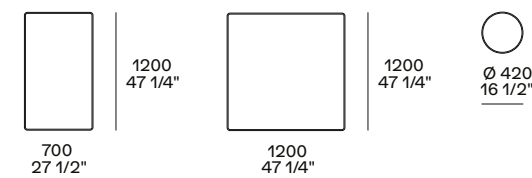

**Jane poltrona  
Jane armchair**

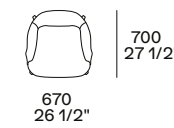

**Orbit tavolini  
Orbit coffee tables**

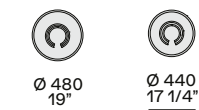

sheffield 01 pepe tessuto - fabric



dundee 01 pepe tessuto - fabric



norwich 01 bianco tessuto - fabric



brown nickel opaco mat brown nickel



silk 03 talpa pelle - leather

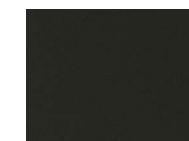

brown nickel lucido glossy brown nickel



5059 fumé vetro - glass

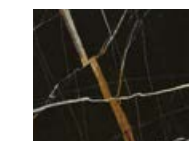

sahara noir marmo levigato mat marble



olmo nero black elm



3051 bronzato vetro - glass

TECHNICAL DATA

NEW FABRICS

116

BRISTOL

118

BRISTOL SYSTEM

126

FINISHINGS

128



NUOVI TESSUTI  
NEW FABRICS

**Dundee  
fabric cat. G**



01 pepe

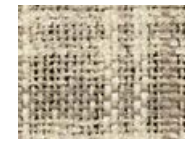

02 sabbia



03 tortora



04 bronzo



06 polvere

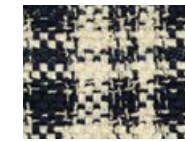

07 notte

**Norwich  
fabric cat. G**



01 bianco

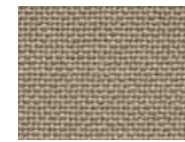

02 sabbia

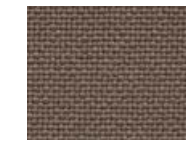

03 tortora



04 bronzo

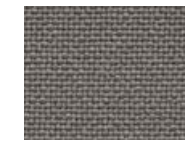

05 ghiaccio

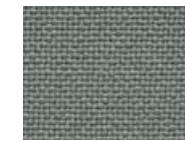

06 polvere

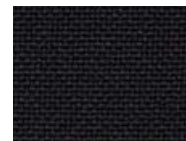

07 notte



08 corallo

**Sheffield  
fabric cat. G**



01 pepe

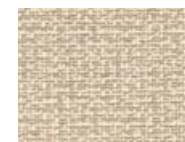

02 sabbia



03 tortora



04 bronzo



05 ghiaccio



06 polvere



07 notte



08 corallo

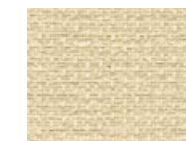

09 burro

## BRISTOL

Design Jean-Marie Massaud, 2013-2021

Struttura in poliuretano flessibile stampato. Cuscino seduta in poliuretano flessibile sagomato, prriverestimento parti in tela cotone e piuma e parti in fibra di poliestere. Cuscinata comfort, cuscino schienale in piuma con inserto in poliuretano flessibile, prriverestimento in cotone. Cuscinata singola, cuscino schienale in Solotex, prriverestimento in cotone. Cuscinata doppia, cuscino schienale anteriore in Solotex, prriverestimento in cotone; cuscino schienale posteriore in poliuretano flessibile, prriverestimento in fibra di poliestere. Cuscinata libera, cuscini in piuma con prriverestimento in cotone. Cuscini opzionali e poggiatesta in piuma con prriverestimento in cotone. Piedini arretrati in materiale plastico (h 45 di serie e h 65 mm) o piedini opzionali in pressofusione d'alluminio verniciato brown nickel opaco e lucido (h 45 mm). Rivestimento sfoderabile in tessuto o pelle.

Structure in flexible moulded polyurethane. Seat cushion in flexible shaped polyurethane, pre-cover with parts in cotton cloth and feather and parts in polyester fibre. Comfort backrest cushion, backrest cushion in down with insert in flexible polyurethane, pre-cover in cotton. Single backrest cushion, backrest cushion in Solotex, pre-cover in cotton cloth. Double backrest cushion, front backrest cushion in Solotex, pre-cover in cotton; back backrest cushion in flexible polyurethane, pre-cover in polyester fibre. Loose cushions, cushions in down with pre-cover in cotton. Optional cushions and lower back cushion in down with pre-cover in cotton. Invisible feet in plastic material (h 1 3/4" standard and 2 1/2") or optional feet in aluminium die casting painted mat and glossy brown nickel (h 1 3/4"). Removable cover in fabric or leather.

### Cuscinata schienale Backrest cushion



cuscinata comfort  
comfort cushion



cuscinata singola  
single cushion



cuscinata doppia  
double cushion

### Cuscinata libera Loose cushions



### Piedini Feet



arretrato, h 45 mm di serie o h 65 mm  
recessed, h 1 3/4" standard or h 2 1/2"



estetico opzionale h 45 mm  
optional h 1 3/4"

#### NB

Il divano è disponibile in due altezze:  
- h 660 mm, seduta h 360 mm,  
piedino arretrato di serie o estetico  
opzionale h 45 mm.  
- h 680 mm, seduta h 380 mm,  
piedino arretrato su richiesta h 65 mm.

È sconsigliato per motivi di allineamento  
l'utilizzo degli elementi retro divano  
Bristol System con piedino h 65 mm.

The sofa is available in two heights:  
- h 26", seat h 14 1/4",  
standard recessed feet or optional  
feet h 1 3/4".  
- h 26 3/4", seat h 15", recessed  
feet on request h 2 1/2".

For alignment reason it is not recommended  
to use Bristol System furniture with feet  
h 2 1/2".

### Divano con cuscinata comfort Sofa with backrest cushion comfort

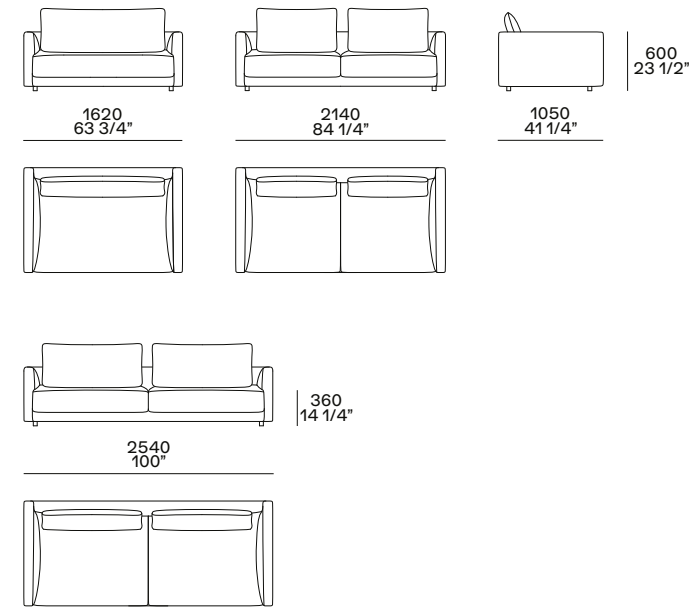

### Divano con cuscinata singola o doppia Sofa with single or double backrest cushion

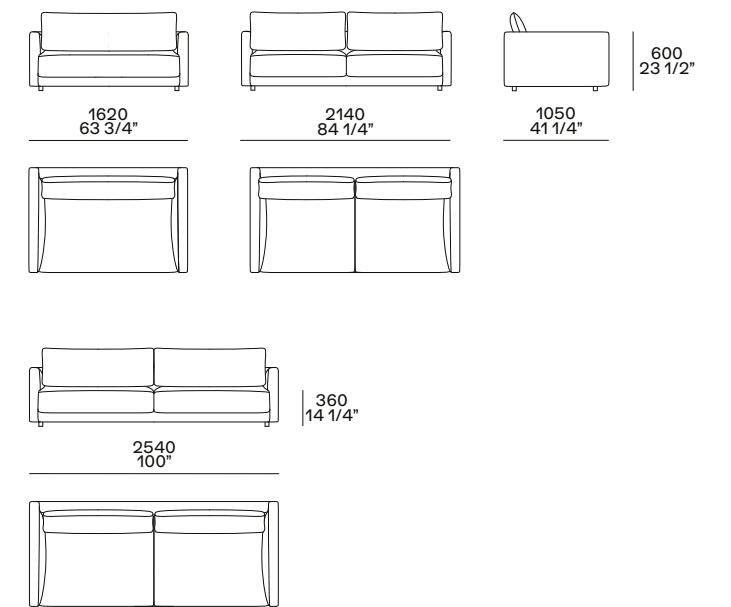

### Divano con cuscinata libera Sofa with loose cushions

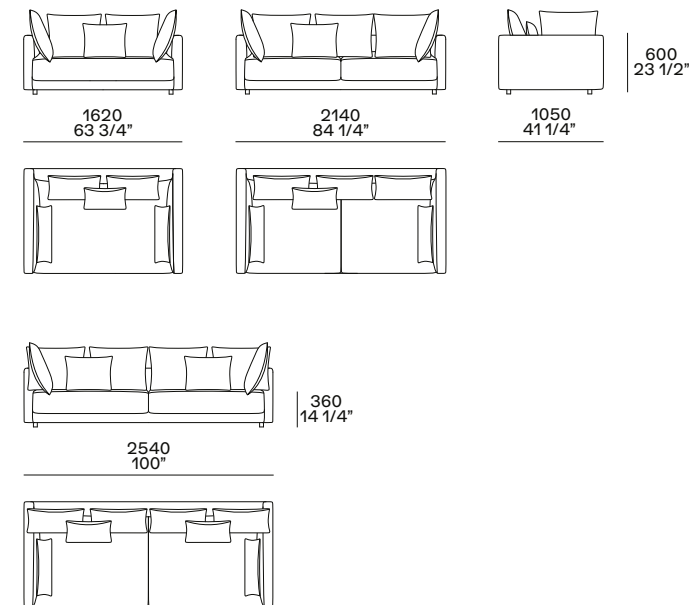

### Poggiatesta Headrest

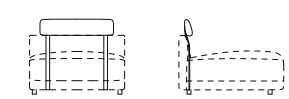

larghezza 750 mm - solo con cuscinata doppia  
width 750 mm - only with double cushion

### Bracciolo fisso h 482 Fixed arm h 19"

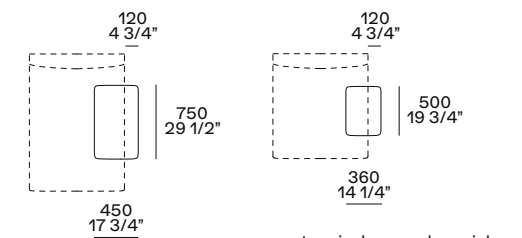

per elemento Day Bed  
for Day Bed unit

per terminale senza bracciolo  
for end unit without arm

### Pouf centrostanza Freestanding pouf

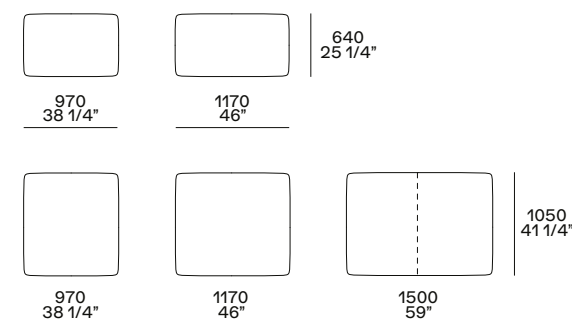

### Cuscini opzionali Optional cushions

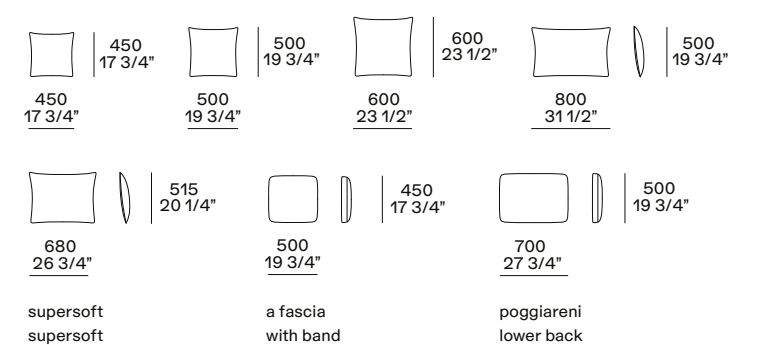

**Bristol cuscineria comfort**  
**Bristol comfort cushion**

**Cuscini schienale**  
**Backrest cushions**

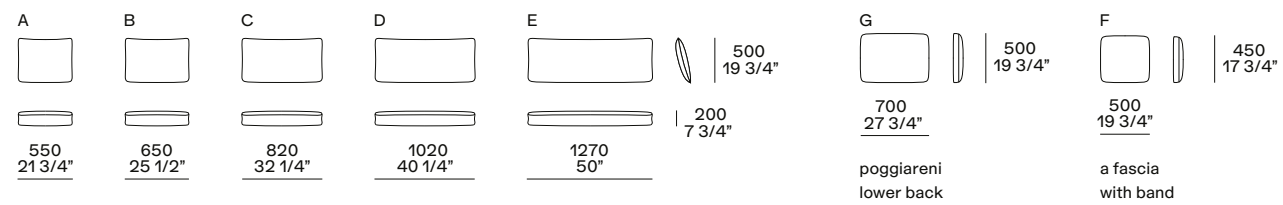

**Divano**  
**Sofa**

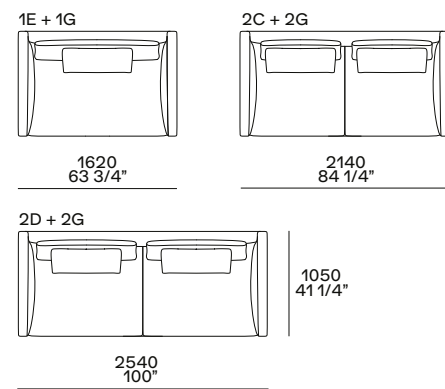

**Terminale sx-dx**  
**Lt-rt end unit**

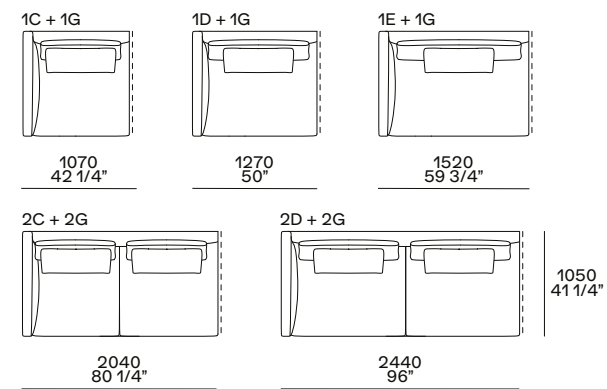

**Terminale senza bracciolo sx-dx**  
**Lt-rt end unit whitout arm**

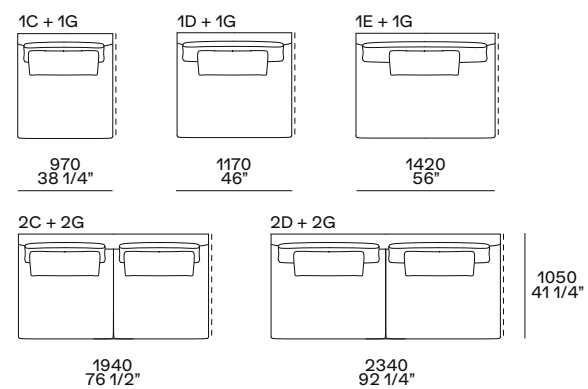

**Centrale**  
**Central unit**

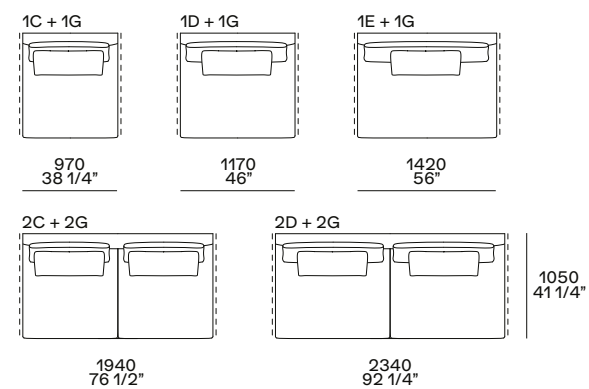

**Angolo sx-dx**  
**Lt-rt corner unit**

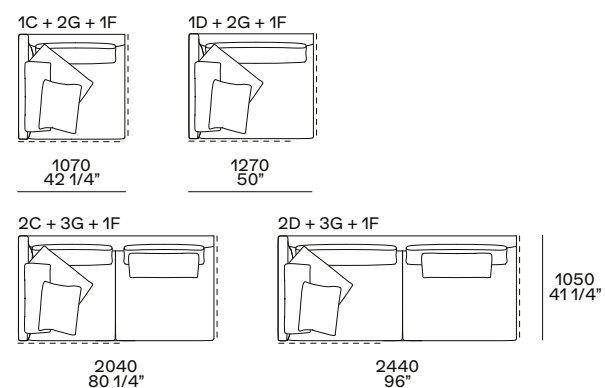

**Terminale angolo sx-dx**  
**Lt-rt corner end unit**

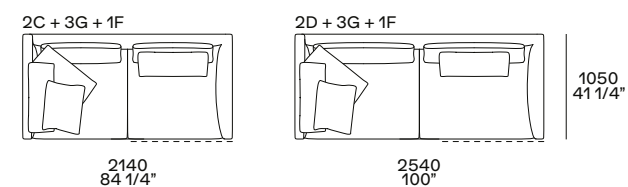

**Elemento inclinato**  
**Angled unit**

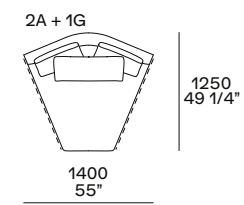

terminale, centrale o angolo  
end unit, central or corner unit

**Elemento inclinato pouf**  
**Angled unit pouf**

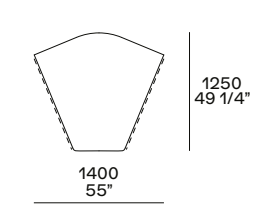

terminale, centrale o angolo  
end unit, central or corner unit

**Chaise longue**  
**Chaise longue**

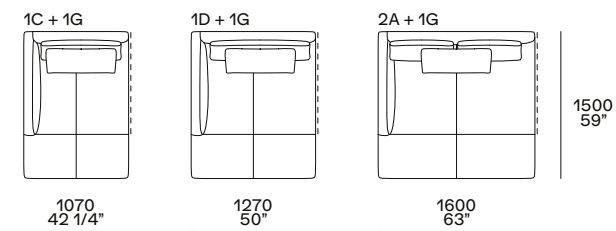

uso centrostanza o terminale  
freestanding or end unit

**Day Bed**  
**Day Bed**

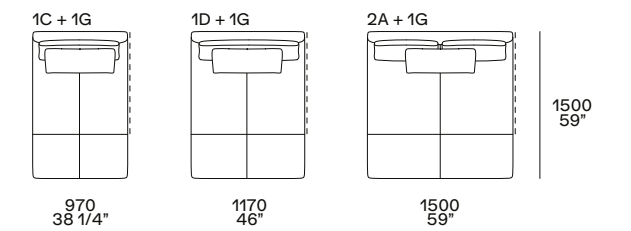

uso centrostanza, terminale o centrale  
freestanding, end unit or central unit

**Pouf terminale sx-dx**  
**Lt-rt end unit pouf**

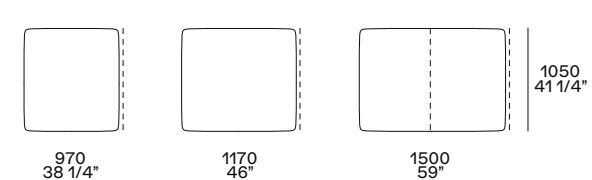

**Pouf angolo sx-dx**  
**Lt-rt corner pouf**

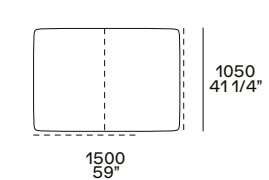

**Pouf centrale**  
**Central unit pouf**

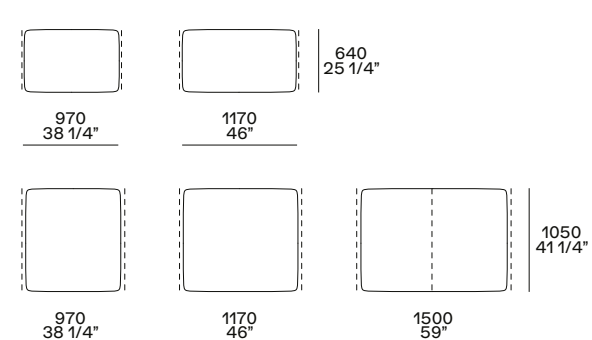

Si consiglia l'utilizzo del seguente schema per un perfetto comfort nell'utilizzo del divano.  
Poliform suggests to follow this cushion combination to grant the perfect comfort of the sofa.

**Bristol cuscineria singola o doppia**  
**Bristol single or double backrest cushion**

**Cuscini schienale**  
**Backrest cushions**

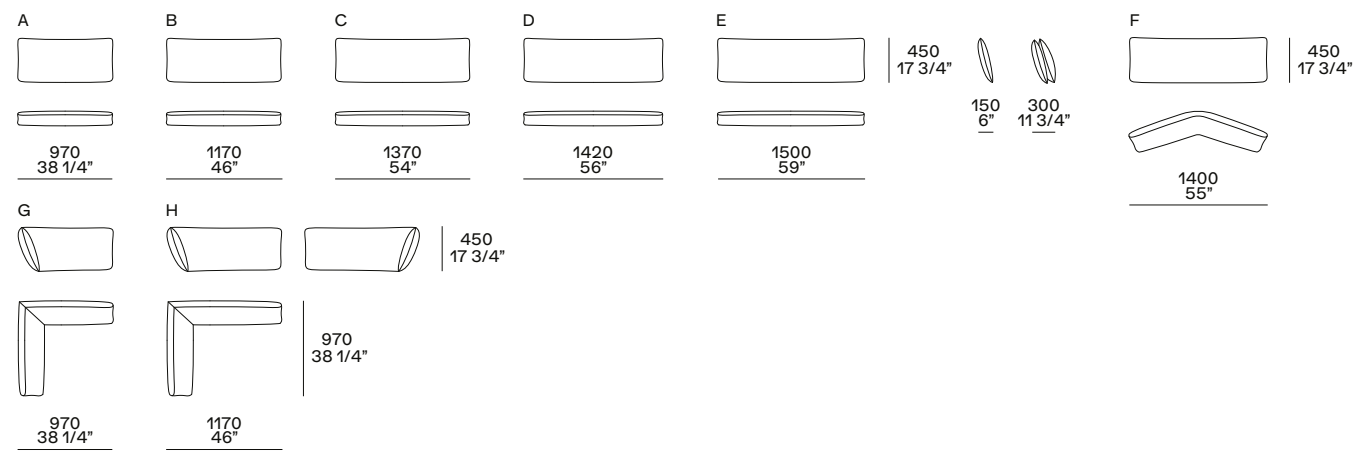

**Divano**  
**Sofa**

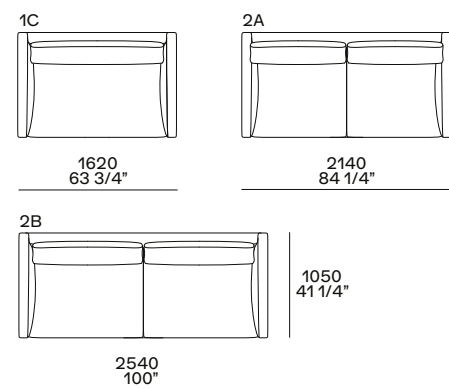

**Terminale sx-dx**  
**Lt-rt end unit**

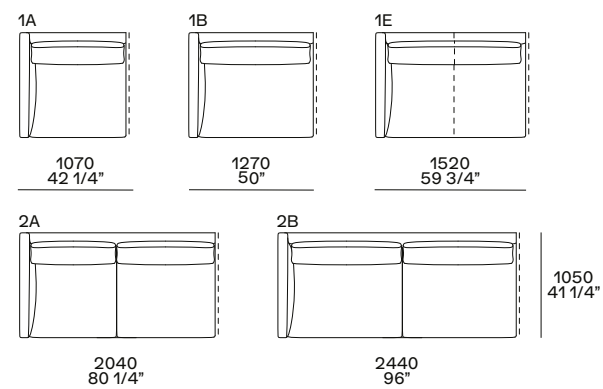

**Terminale senza bracciolo sx-dx**  
**Lt-rt end unit whitout arm**

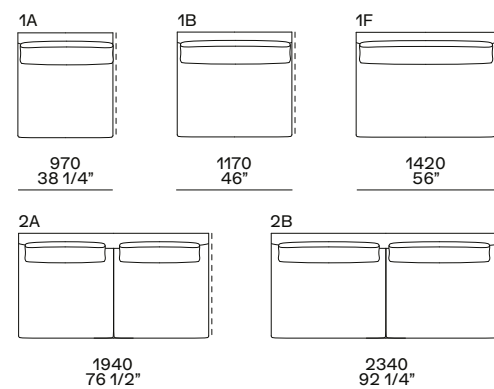

**Centrale**  
**Central unit**

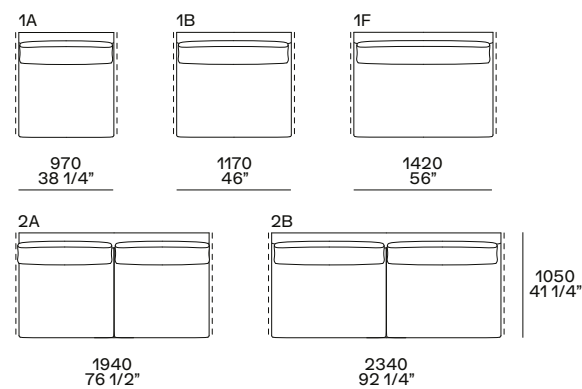

**Elemento inclinato**  
**Angled unit**

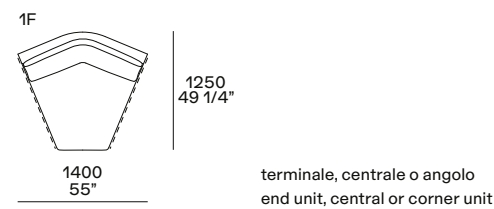

**Elemento inclinato pouf**  
**Angled unit pouf**

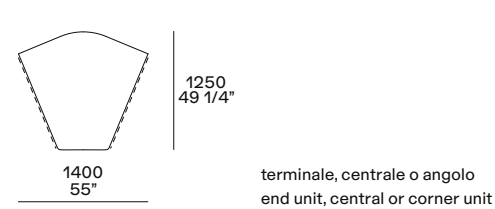

**Angolo sx-dx**  
**Lt-rt corner unit**

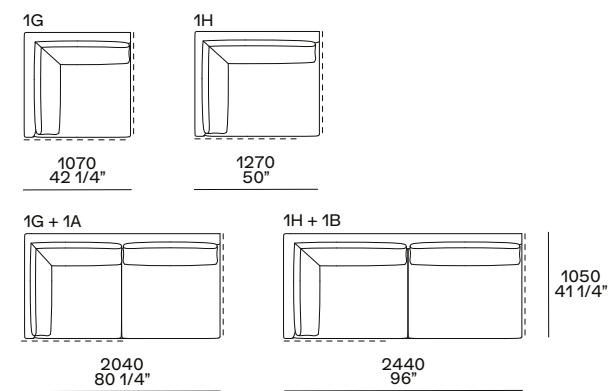

**Terminale angolo sx-dx**  
**Lt-rt corner end unit**

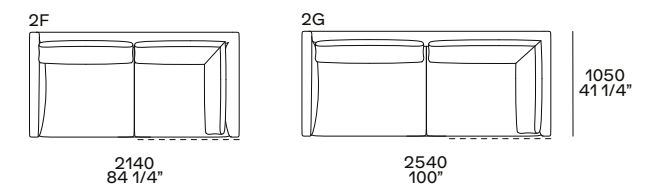

**Chaise longue**  
**Chaise longue**

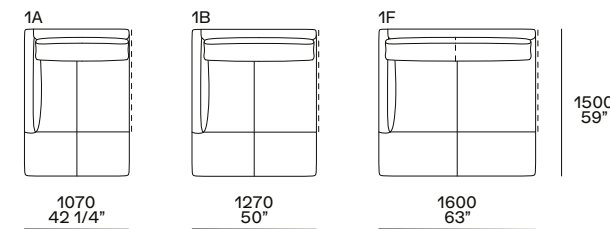

uso centrostanza o terminale  
 freestanding or end unit

**Day Bed**  
**Day Bed**

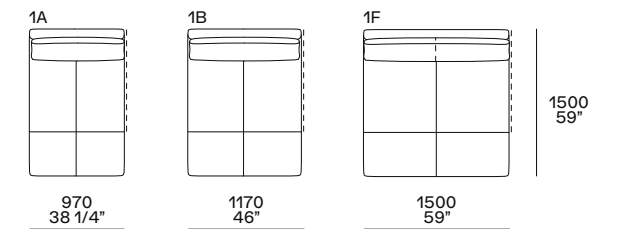

uso centrostanza, terminale o centrale  
 freestanding, end unit or central unit

**Pouf terminale sx-dx**  
**Lt-rt end unit pouf**

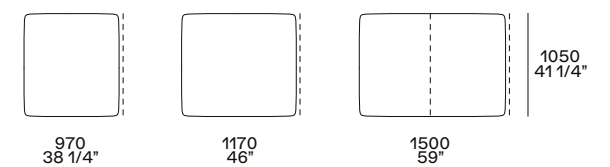

**Pouf angolo sx-dx**  
**Lt-rt corner pouf**

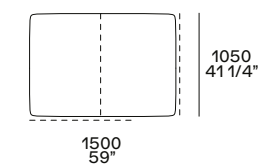

**Pouf centrale**  
**Central unit pouf**

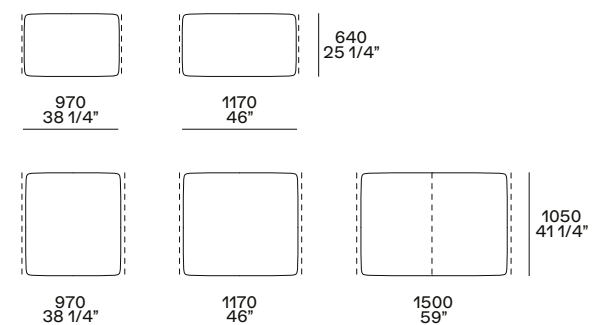

Si consiglia l'utilizzo del seguente schema per un perfetto comfort nell'utilizzo del divano.  
 Poliform suggests to follow this cushion combination to grant the perfect comfort of the sofa.

**Bristol cuscineria libera**  
**Bristol loose cushions**

**Cuscini**  
**Cushions**

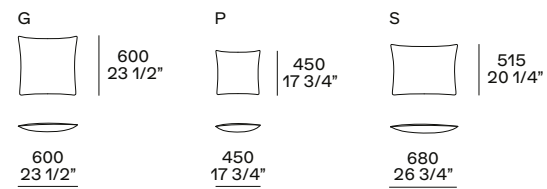

**Divano**  
**Sofa**

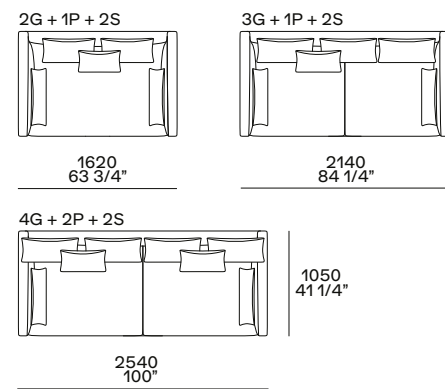

**Terminale sx-dx**  
**Lt-rt end unit**

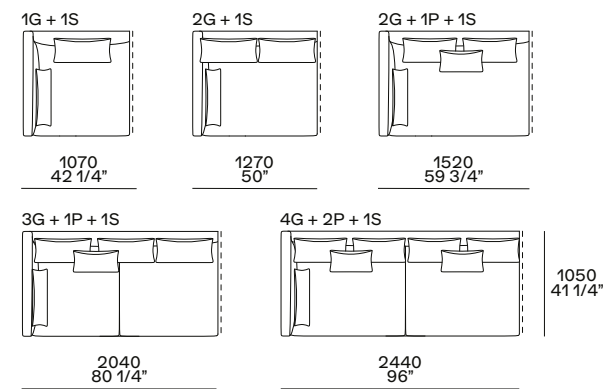

**Terminale senza bracciolo sx-dx**  
**Lt-rt end unit whitout arm**

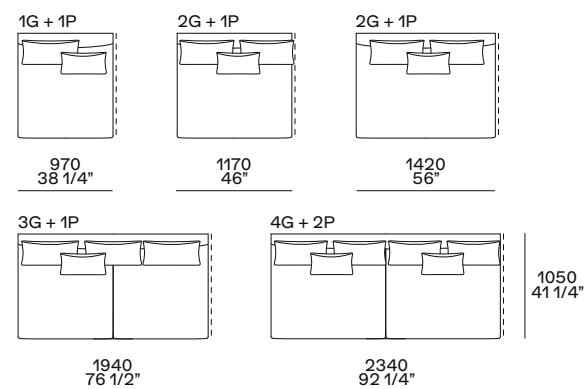

**Centrale**  
**Central unit**

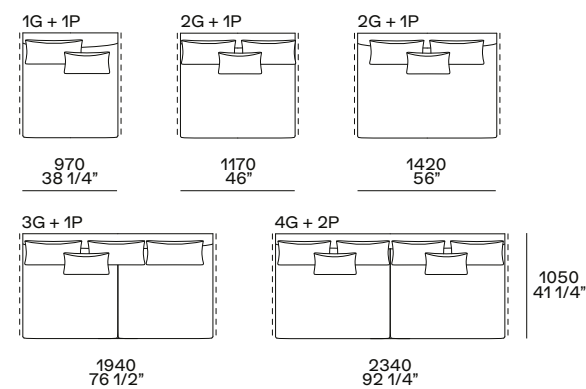

**Angolo sx-dx**  
**Lt-rt corner unit**

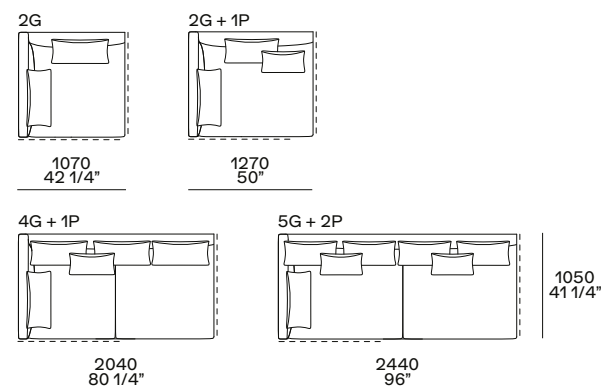

**Terminale angolo sx-dx**  
**Lt-rt corner end unit**

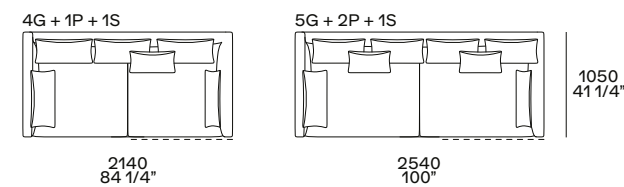

**Elemento inclinato**  
**Angled unit**

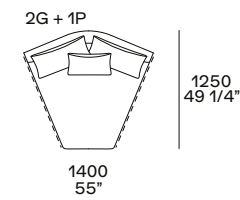

terminale, centrale o angolo  
 end unit, central or corner unit

**Elemento inclinato pouf**  
**Angled unit pouf**

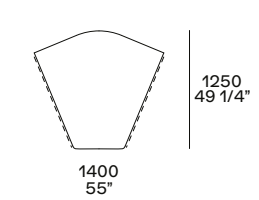

terminale, centrale o angolo  
 end unit, central or corner unit

**Chaise longue**  
**Chaise longue**

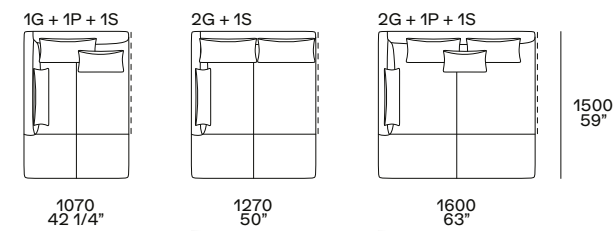

uso centrostanza o terminale  
 freestanding or end unit

**Day Bed**  
**Day Bed**

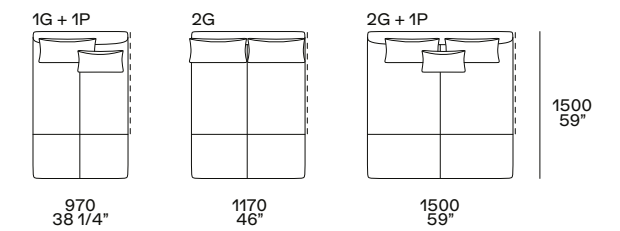

uso centrostanza, terminale o centrale  
 freestanding, end unit or central unit

**Pouf terminale sx-dx**  
**Lt-rt end unit pouf**

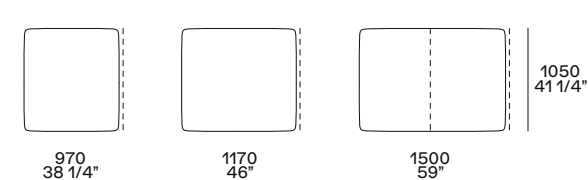

**Pouf angolo sx-dx**  
**Lt-rt corner pouf**

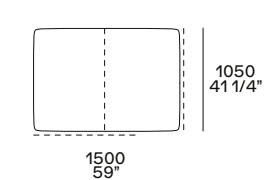

**Pouf centrale**  
**Central unit pouf**

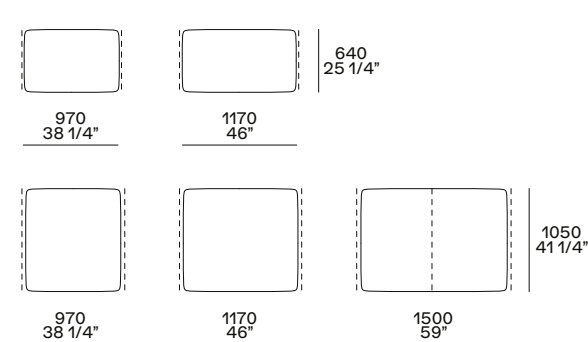

Si consiglia l'utilizzo del seguente schema per un perfetto comfort nell'utilizzo del divano.  
 Poliform suggests to follow this cushion combination to grant the perfect comfort of the sofa.



## BRISTOL SYSTEM

Design Jean-Marie Massaud, 2013-2021

Serie di tavolini centrostanza e retrodivano o da affiancare lateralmente al divano, attrezzabili con una serie di contenitori. Tavolini centrostanza con piani in laccato opaco colori, rovere spessart o olmo nero. Piano superiore disponibile anche in cinque marmi levigati e lucidi (escluso emperador dark e sahara noir). Inserti e piedini in metallo verniciato brown nickel opaco o lucido. Tavolini retrodivano con struttura in laccato opaco colori, rovere spessart o olmo nero. Inserti e piedini in alluminio verniciato brown nickel opaco o lucido. Contenitori in laccato opaco colori, rovere spessart o olmo nero.

Series of coffee tables for central use and coffee tables to the back of the sofa or side tables, accessorized with different storage units. Coffee tables for central use with shelves in mat lacquered colours, spessart oak or black elm. Top shelf available also in five mat and glossy marbles (except emperador dark and sahara noir). Inlays and feet in mat or glossy brown nickel painted metal. Coffee tables at the back of the sofa with structure available in mat lacquered colours, spessart oak or black elm. Inlays and feet in mat or glossy brown nickel painted aluminium. Storage units in mat lacquered colours, spessart oak or black elm.

### Elemento retro divano Element to be placed at the back of the sofa

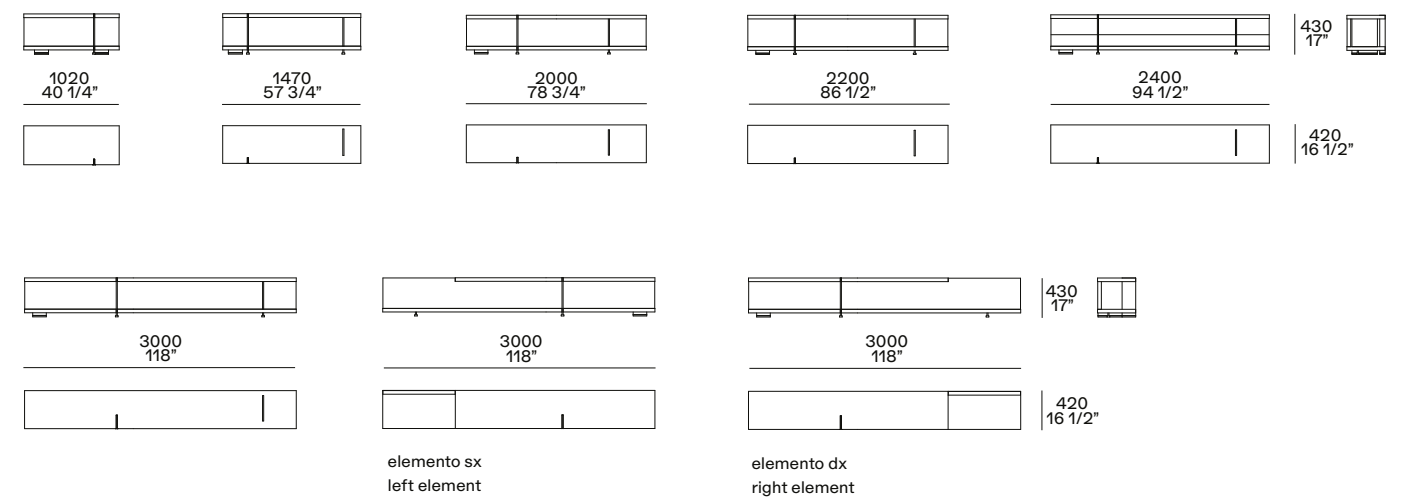

### Contenitore anta ribalta o cassetto Storage unit flap door or drawer

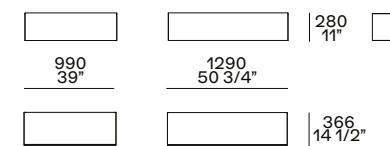

### Tavolino centrostanza Freestanding coffee table

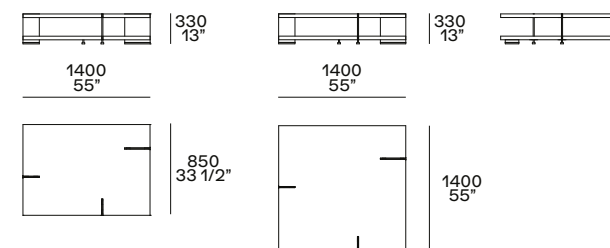

#### NB

È sconsigliato per motivi di allineamento l'utilizzo degli elementi retro divano Bristol System con divano Bristol h 680 mm.

The use of Bristol System furniture is not recommended with Bristol sofa h 26 3/4".

FINITURE BRISTOL DIVANO  
BRISTOL SOFA FINISHINGS

**Tessuto**  
**Fabrics**

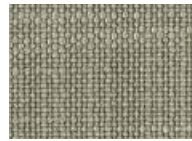

atlanta cat. b  
12 colori - colours



caleo cat. b  
15 colori - colours



chios cat. b  
13 colori - colours



eraclea cat. b  
12 colori - colours

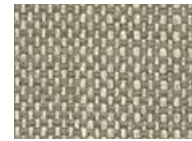

aspen cat. c  
12 colori - colours

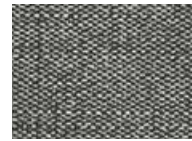

lima cat. c  
11 colori - colours



siviglia cat. c  
14 colori - colours



antea cat. d  
13 colori - colours



cordoba cat. d  
13 colori - colours



corinto cat. d  
5 colori - colours



indra cat. d  
12 colori - colours



itaca cat. d  
10 colori - colours



kushiro cat. d  
13 colori - colours



lipsi cat. d  
11 colori - colours



micene cat. d  
9 colori - colours



milos cat. d  
5 colori - colours

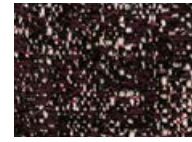

olimpia cat. d  
14 colori - colours



oxford cat. d  
8 colori - colours



rabat cat. d  
10 colori - colours

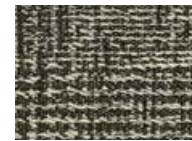

sendai cat. d 5-8 ■  
5 colori - colours



sparta cat. d  
12 colori - colours



agadir cat. e  
9 colori - colours



arcadia cat. e  
12 colori - colours



argo cat. e  
13 colori - colours



hannover cat. e  
11 colori - colours



kitami cat. e  
12 colori - colours



naxos cat. e  
11 colori - colours



nayoro cat. e  
10 colori - colours



orleans cat. e  
10 colori - colours



persia cat. e  
16 colori - colours



skyros cat. e  
12 colori - colours



zante cat. e  
11 colori - colours



brest cat. g  
10 colori - colours



dundee cat. g 5-8 ■  
7 colori - colours



glasgow cat. g  
6 colori - colours



lero cat. g  
2 colori - colours



nancy cat. g  
6 colori - colours

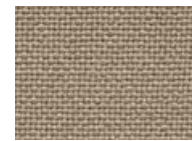

norwich cat. g  
7 colori - colours



sheffield cat. g  
7 colori - colours



siro cat. g  
4 colori - colours

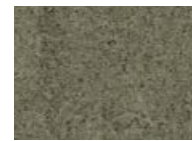

tebe cat. g □  
11 colori - colours

■ Rivestimento divano non consigliato, note giustificative:

- 1 tessuto basico poco coprente
- 2 tessuto compatto e rigido
- 3 possibili tensioni del tessuto sulle curve del prodotto
- 4 possibili arricciature e pieghe lungo le cuciture
- 5 possibili cambi di colore del tessuto sulle giunzioni
- 6 possibili schiacciature del vello sulle cuciture
- 7 possibile cambio di colore del tessuto tra piano e lati del prodotto
- 8 non è garantita la corrispondenza del disegno
- 9 possibile cambio di direzione del pelo tra fronte e retro
- 10 pelle coperta e stabile, possibili arricciature sulle curve

Sofa cover not recommended, supporting notes:

- 1 basic and slightly coverage fabric
- 2 compact and rigid fabric
- 3 possible fabric stiffness on the curved shapes of the product
- 4 possible fabric puckers and folds along the seams
- 5 possible fabric colour changes on the joints
- 6 possible fleece flattening along the seams
- 7 possible colour difference of the fabric between top and sides of the product
- 8 the correspondence of the drawing is not guaranteed
- 9 possible change of the fur direction between front and back
- 10 possible puckers on curves because of covered and stable leather

□ Il prodotto per esigenze di taglio e confezione presenterà giunte supplementari.

The product will have additional joints because of cutting and sewing needs.

**Pelle**  
**Leather**



spring cat. p 10 ■  
13 colori - colours



colors cat. s □  
25 colori - colours

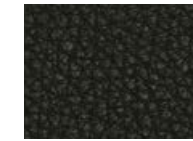

silk cat. s  
13 colori - colours

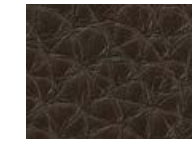

deep cat. x  
10 colori - colours



special cat. x  
21 colori - colours

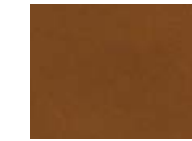

nabuk cat. y  
10 colori - colours



invecchiata cat. y  
6 colori - colours



soft cat. y  
14 colori - colours

**Piedini opzionali**  
**Optional feet**



brown nickel opaco  
mat brown nickel



brown nickel lucido  
glossy brown nickel

**Struttura bracciolo fisso**  
**Fixed arm structure**



brown nickel opaco  
mat brown nickel



brown nickel lucido  
glossy brown nickel

FINITURE BRISTOL SYSTEM  
BRISTOL SYSTEM FINISHINGS

**Laccato opaco**  
**Mat lacquer**

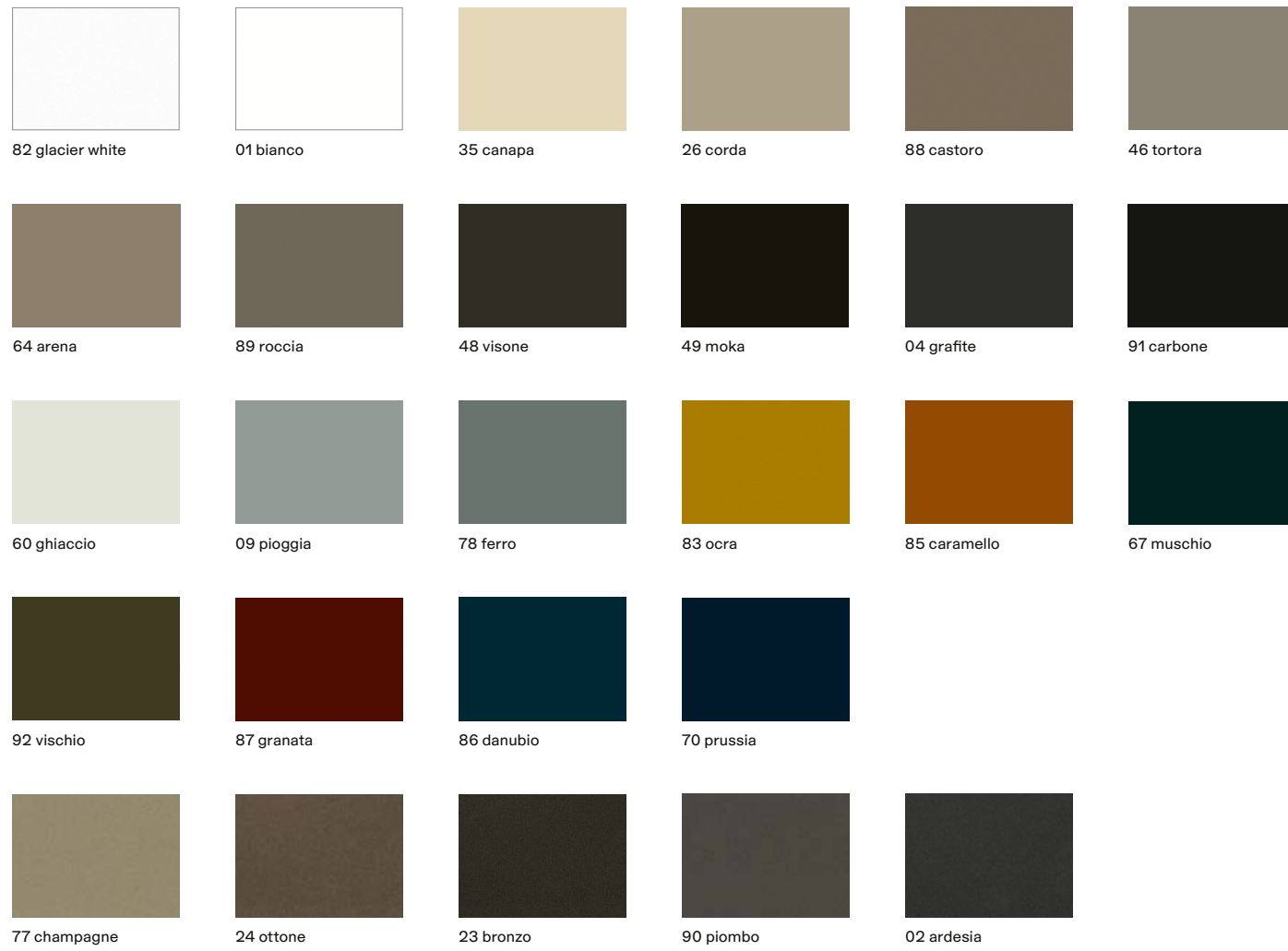

**Essenza**  
**Wood**

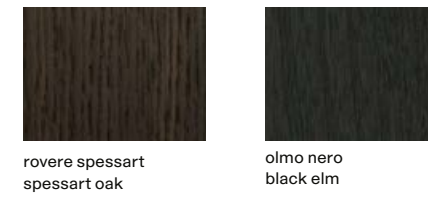

**Marmo levigato**  
**Mat marble**



**Marmo lucido**  
**Glossy marble**



**Inserti e piedini**  
**Inlays and feet**



**Poliform Spa**  
via Montesanto 28  
Casella postale n. 1  
22044 Inverigo (CO) Italy  
t +39 031 6951  
f +39 031 699444  
info@poliform.it  
poliform.it



2018 Adi Compasso D'oro  
Career Award

**Poliform realizza tutte le sue collezioni in Italia usando componenti e materie prime selezionate.**

**All the Poliform collections are manufactured 100% in Italy using top-class components and materials.**

Poliform si riserva il diritto di apportare, senza preavviso, ogni modifica mirata al miglioramento funzionale e qualitativo dei propri prodotti. Testi e disegni presenti in questo stampato hanno scopo divulgativo: per ogni aspetto tecnico e dimensionale fare riferimento ai listini aziendali e relativi aggiornamenti. I campioni di colori e materiali hanno valore indicativo.

Poliform reserves the rights at all time to apply modifications for the functional or qualitative improvement of its products. Texts and drawings present in this brochure have a divulgative purpose: for every technical and dimensional aspect please refer to the company's price lists and their relative updatings. The colour and material samples have an indicative value.

**Creative Direction**  
Apartamento Studios

**Graphic Design**  
Apartamento Studios

**Interiors Photography**  
Federico Cedrone, Omar Sartor

**Still Life Photography**  
Silvia Orlandi

**Interiors Styling**  
Poliform Lab

1st edition September 2021  
cod. 122/R1/2021



