

Poliform

# PHOENIX

KITCHENS

# Poliform

PHOENIX KITCHEN  
DIGITAL CATALOGUE

Da un'intuizione progettuale di Poliform nasce Phoenix, una cucina caratterizzata dal particolare disegno dell'apertura a gola, di volta in volta personalizzato. Una soluzione innovativa, capace di trasformare un dettaglio tecnico in un dettaglio estetico che si armonizza con ogni tipologia di finitura, dall'acciaio al massello, e con tutti gli altri elementi della cucina.

From a project intuition of Poliform arises Phoenix, a kitchen characterised by the particular design of the groove opening, customised each time. An innovative solution, able to transform a technical detail into an aesthetic detail that harmonises with every type of finish, from steel to solid wood, and with all the other elements of the kitchen.

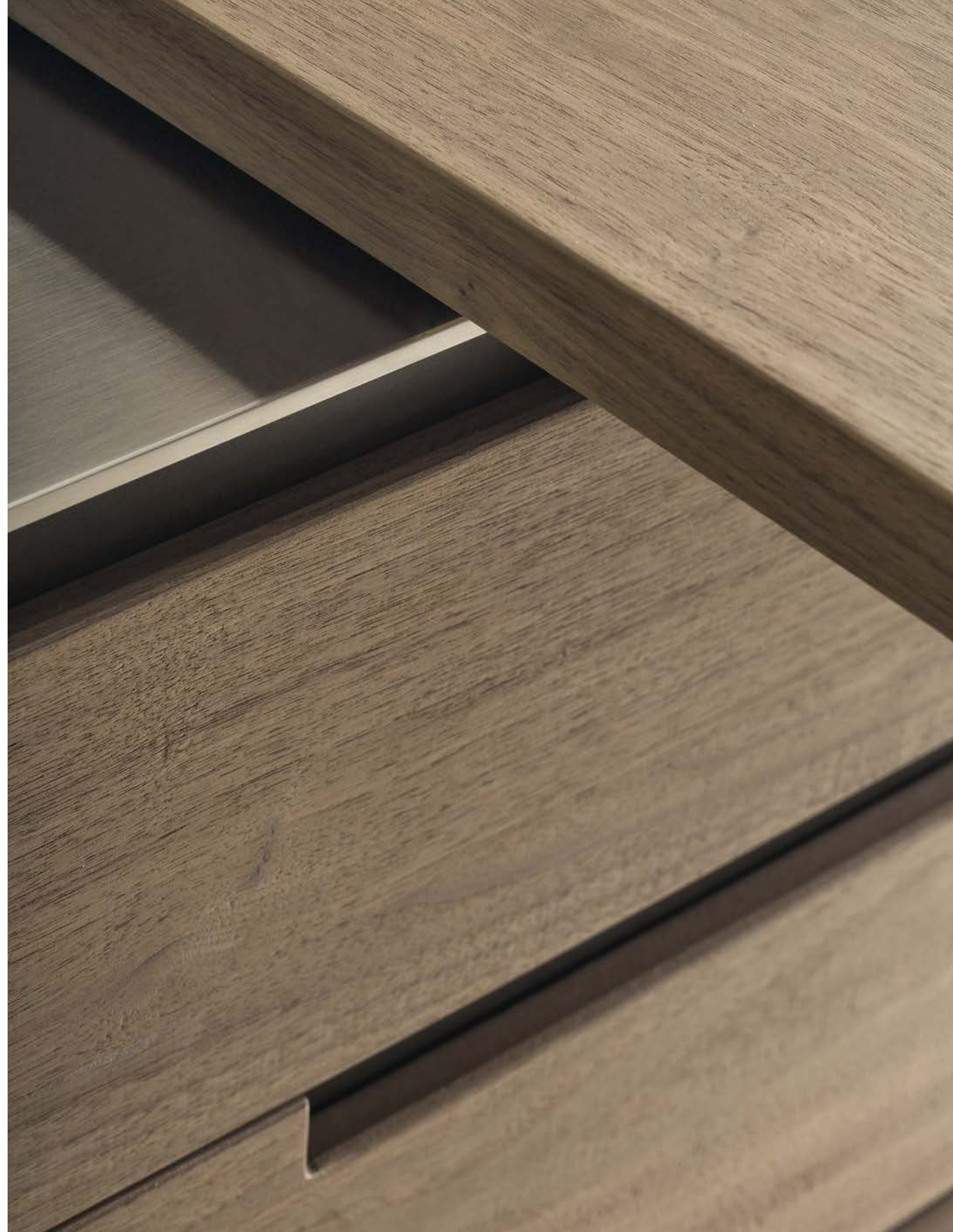



Qui e nelle pagine precedenti: basi con ante, cassetti ed estrattori in acciaio scotch brite e sagoma frontale in laccato gofrato carbone. Cappa Factory a isola in acciaio scotch brite. Colonne High con ante in olmo nero e distanziatori verticali in laccato gofrato carbone. La colonna a sinistra ha ante a scomparsa e vano attrezzato con Shaker portabicchieri, ripiani in alluminio anodizzato moka e schienale in olmo nero. In appoggio sulle basi, piano snack Blade in olmo nero. Sgabelli Ventura in olmo nero con seduta rivestita in pelle non sfoderabile Soft 4 cognac. Tavolino Dama in legno massello noce canaletto.

This and previous pages: base units with doors, drawers and pull-out storage baskets in scotch brite steel and front profile in embossed lacquered carbone. Factory island-hood in scotch brite steel. High tall units with doors in black elm and vertical spacers in embossed lacquered carbone. The tall unit on the left has pocket doors and an equipped compartment with Shaker cup holder, shelves in moka anodized aluminium and back panel in black elm. On the base units is the Blade snack top in black elm. Ventura stools in black elm with seat covered in non-removable leather Soft 4 cognac. Dama small table in solid walnut canaletto.





A sinistra: basi con ante, cassetti ed estrattori in acciaio scotch brite e sagoma frontale in laccato goffrato carbone. Cappa Factory a isola in acciaio scotch brite. Colonne High con ante in olmo nero e distanziatori verticali in laccato goffrato carbone. Tavolino Dama in legno massello noce canaletto. Sotto: dettaglio della base con cassetti. Frontale in acciaio scotch brite, piano in acciaio scotch brite KitchenAid con telaio di supporto in laccato goffrato carbone, fianco di finitura in acciaio scotch brite.

To the left: base units with doors, drawers and pull-out storage baskets in scotch brite steel and front profile in embossed lacquered carbone. Factory island-hood in scotch brite steel. High tall units with doors in black elm and vertical spacers in embossed lacquered carbone. Dama small table in solid walnut canaletto. Below: a detail of the base unit with drawers. Front profile in scotch brite steel, top in scotch brite steel KitchenAid with embossed lacquered carbone support frame, scotch brite steel on the side.







Nelle pagine precedenti: basi con ante, cassetti ed estrattori in acciaio scotch brite e sagoma frontale laccato goffrato carbone, piano in acciaio scotch brite KitchenAid con telaio di supporto laccato goffrato carbone. Cappa Factory a isola in acciaio scotch brite. Colonne High con ante in olmo nero e distanziatori verticali in laccato goffrato carbone. Piano snack Blade in olmo nero e sgabelli Ventura in olmo nero con seduta rivestita in pelle non sfoderabile Soft 4 cognac. A sinistra: dettaglio dell'attrezzatura per cassetti con portaposate in wengé, bilancia elettronica in acciaio e contenitori in ceramica. Sotto: dettaglio del piano cottura Pitt Cooking® a sei fuochi con manopole personalizzate Poliform.

Previous pages: base units with doors, drawers and pull-out storage baskets in scotch brite steel and the front profile in embossed lacquered carbone, top in scotch brite steel KitchenAid with embossed lacquered carbone support frame. Factory island-hood in scotch brite steel. High tall units with doors in black elm and vertical spacers in embossed lacquered carbone. Blade snack top in black elm and Ventura black elm stools with seat covered in non-removable leather Soft 4 cognac. Left: a detail of the drawer equipment with wenge cutlery, electronic steel scale and ceramic containers. Below: close up of the hob Pitt Cooking® with six burners with Poliform personalized controls.





A destra: basi con ante, cassetti ed estrattori in acciaio scotch brite e sagoma frontale in laccato goffrato carbone, piano in acciaio scotch brite KitchenAid con telaio di supporto in laccato goffrato carbone. Cappa Factory a isola in acciaio scotch brite. Colonne High con ante in olmo nero e distanziatori verticali in laccato goffrato carbone.

To the right: base units with doors, drawers and pull-out storage baskets in scotch brite steel and front profile in embossed lacquered carbone, top in scotch brite steel KitchenAid with embossed lacquered carbone support frame. Factory island-hood in scotch brite steel. High tall units with doors in black elm and vertical spacers in embossed lacquered carbone.



**PHOENIX**  
Design R&D Poliform

**Basi p 1280**  
Strutture: nobilitato grigio lavagna.  
Ante, cassetti ed estrattori: acciaio scotch brite.  
Maniglie: sagoma laccato goffrato carbone.  
Fianchi: acciaio scotch brite, spessore 6 mm.  
Top: acciaio scotch brite KitchenAid con telaio di supporto laccato goffrato carbone, spessore 6 mm.  
Zoccoli: laccato goffrato carbone.

**Snack**  
Blade: massello tinto olmo nero.

**Colonne con forni p 640**  
Strutture: nobilitato grigio lavagna.  
Ante: olmo nero.  
Maniglie: distanziatore verticale laccato goffrato carbone.  
Fianchi: olmo nero, spessore 26 mm.  
Zoccoli: laccato goffrato carbone.

**Colonne High p 740**  
Strutture: nobilitato grigio lavagna.  
Ante: olmo nero.  
Maniglie: distanziatore verticale laccato goffrato carbone.  
Fianchi: olmo nero, spessore 26 mm.  
Zoccoli: laccato goffrato carbone.

**Complementi**  
Sgabello Ventura: struttura in olmo nero e rivestimento non sfoderabile in pelle Soft 4 cognac.  
Tavolino Dama: legno massello noce canaletto.

**Base units d 50 1/2"**  
Structures: grey lavagna melamine.  
Doors, drawers and pull-out storage baskets: scotch brite steel.  
Handles: profile in embossed lacquered carbone.  
Side panels: scotch brite steel, thickness 1/4".  
Top: scotch brite steel KitchenAid with support frame in embossed lacquered carbone, thickness 1/4".  
Plinths: embossed lacquered carbone.

**Snack**  
Blade: solid wood dyed black elm.

**Tall units with ovens d 25 1/4"**  
Structures: grey lavagna melamine.  
Doors: black elm.  
Handles: vertical spacer in embossed lacquered carbone.  
Side panels: black elm, thickness 1".  
Plinths: embossed lacquered carbone.

**High tall units d 29 1/4"**  
Structures: grey lavagna melamine.  
Doors: black elm.  
Handles: vertical spacer in embossed lacquered carbone.  
Side panels: black elm, thickness 1".  
Plinths: embossed lacquered carbone.

**Accessories**  
Ventura stool: structure in black elm and non-removable cover in leather Soft 4 cognac.  
Dama coffee table: solid walnut canaletto.

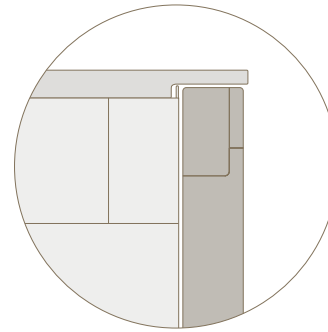

**Basi**  
**Base units**

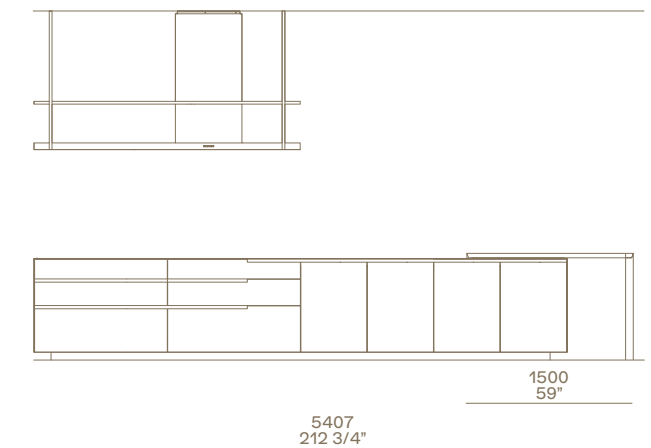
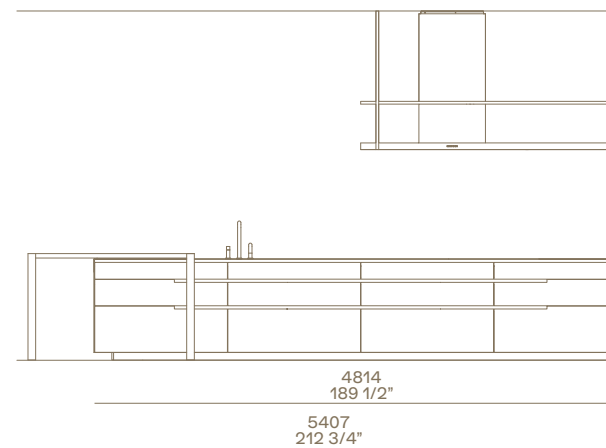

**Colonne**  
**Tall units**

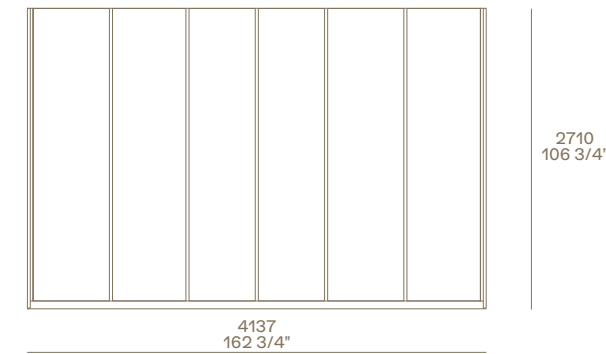

**Colonne**  
**Tall units**

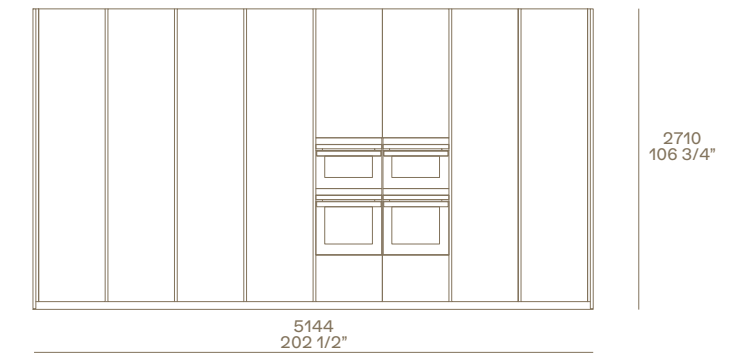

**Ventura**  
Design Jean-Marie Massaud

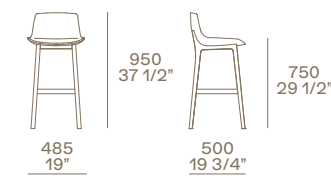

**Dama**  
Design R&D Poliform

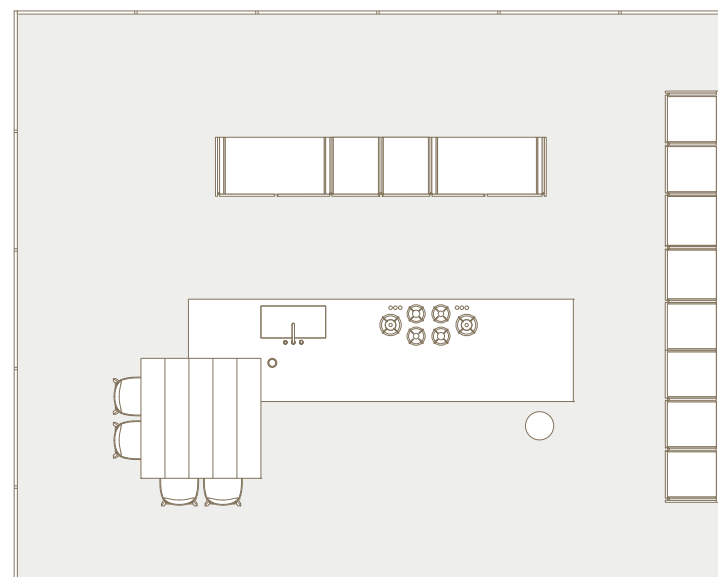
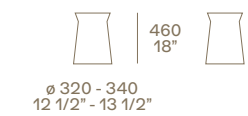

- 1 Colonne High, laterali con ante a scomparsa, colonne centrali con ante ad apertura battente. Vano attrezzato con cassetti, Shaker portacalici e ripiani.
- 2 Lavello in acciaio scotch brite saldato.

- 3 Piano cottura Pitt Cooking®, 6 fuochi, con manopole personalizzate Poliform.
- 4 Presa elettrica a scomparsa.
- 5 Attrezzatura in wengé e acciaio per cassetti ed estrattori.

- 6 Cappa Factory a isola in acciaio scotch brite, personalizzata Poliform.
- 7 Snack Blade quadrato 1500 × 1500.
- 8 Colonne High con forni e frigoriferi attrezzate con cassetti e ripiani, con ante ad apertura battente.

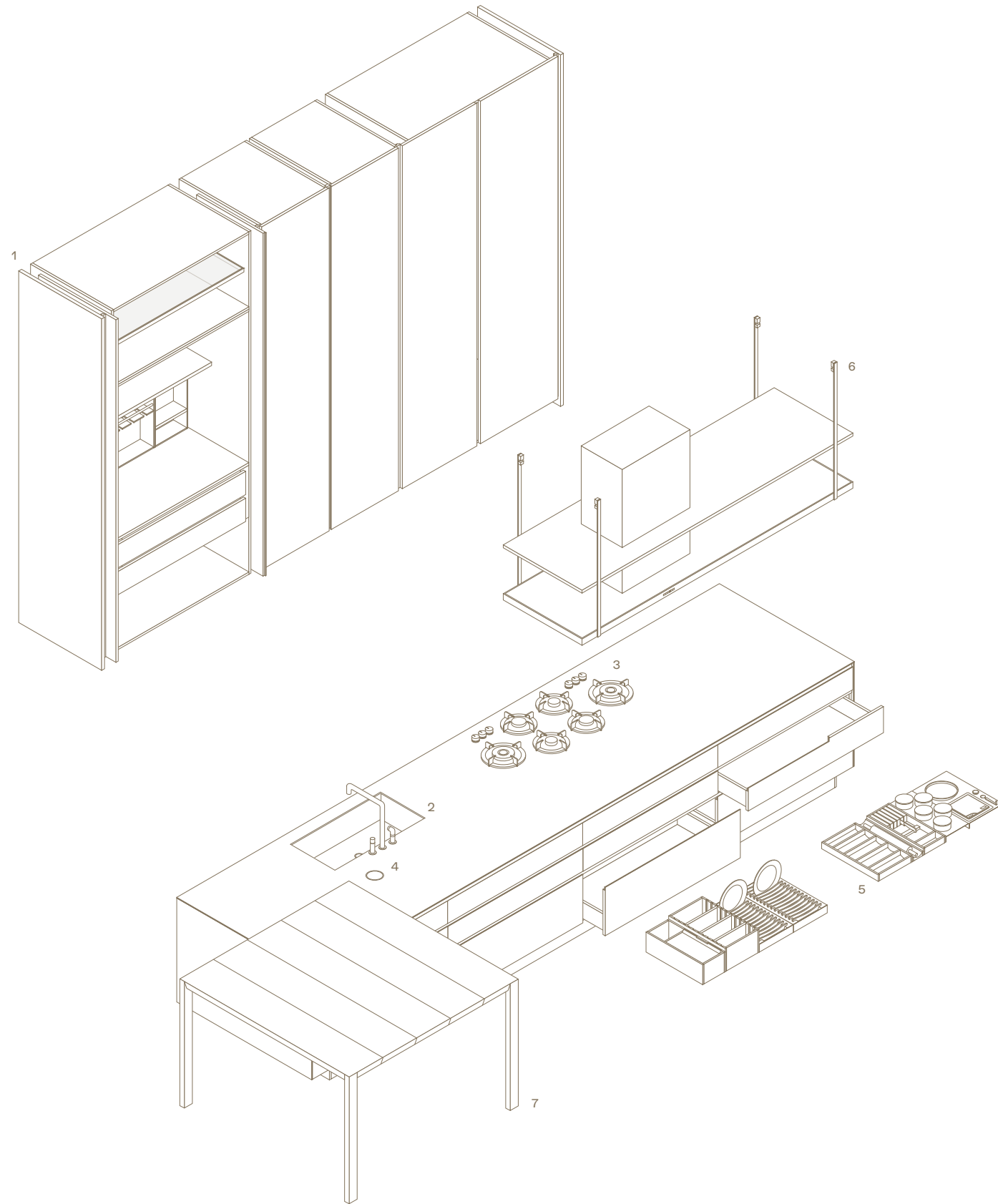

- 1 High tall units, lateral with pocket doors, central units with leaf opening. Compartment equipped with drawers, chalices rack Shaker and shelves.
- 2 Soldered scotch brite steel sink.

- 3 Hob Pitt Cooking® 6 burners, Poliform personalized controls.
- 4 Lift-up power socket.
- 5 Equipment in wenge and steel for drawers and pull-out storage baskets.

- 6 Island-hood Factory in scotch brite steel, personalized Poliform.
- 7 Square snack Blade 59" x 59".
- 8 High tall units with ovens and refrigerators, equipped with drawers and shelves, leaf doors.

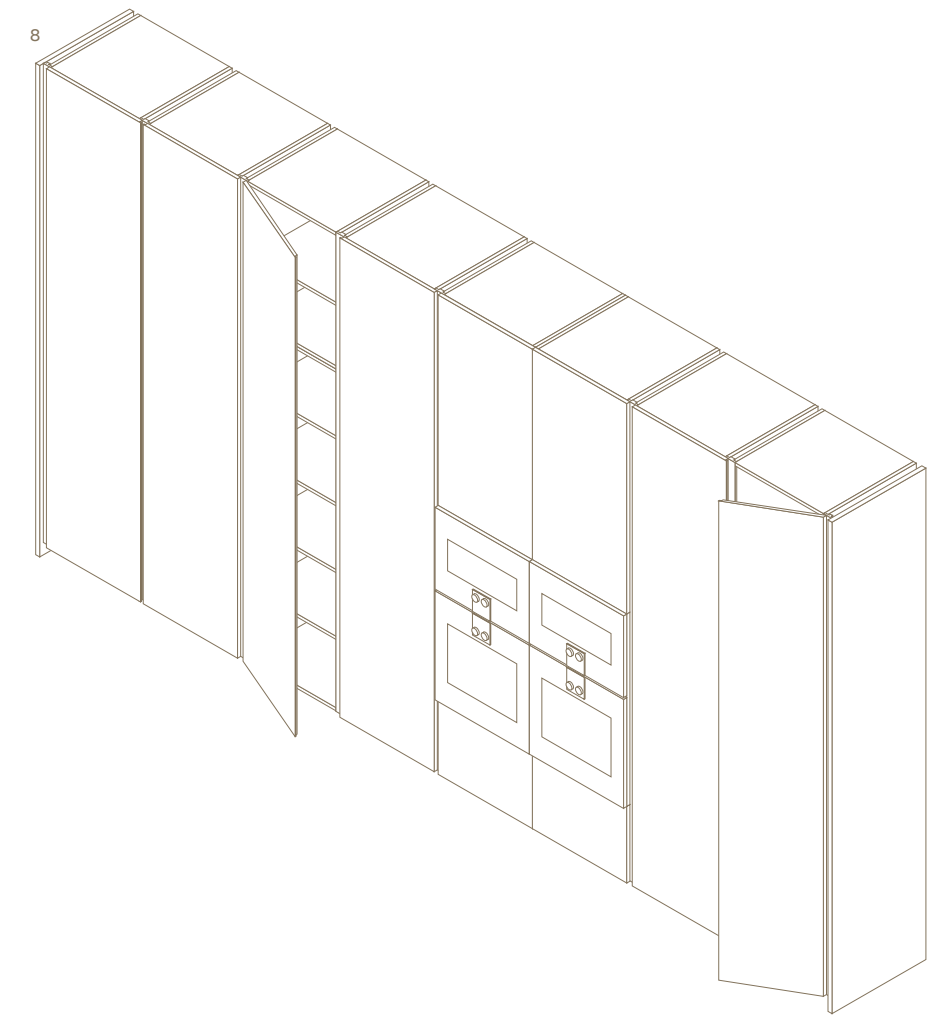

A destra: basi con ante, cassetti ed estrattori in massello noce canaletto, top in acciaio scotch brite Barazza. Cappe a isola in acciaio scotch brite. Pensili con ante vetrina PR22 in vetro riflettente fumé e profilo in alluminio anodizzato nero, mensole in laccato goffrato carbone e schienali in noce c. Colonne con ante in laccato goffrato glacier white.

To the right: base units with doors, drawers and pull-out storage baskets in walnut canaletto solid wood, top in scotch brite steel Barazza. Island-hoods in scotch brite steel. Wall units with fumé reflecting glass doors and black anodized aluminium profile PR22, shelves in embossed lacquered carbone, back panels in walnut c. Tall units with doors in embossed lacquered glacier white.





Qui e nelle pagine precedenti: basi con ante, cassetti ed estrattori in massello noce canaletto, top in acciaio scotch brite Barazza. Cappe a isola in acciaio scotch brite. Pensili con ante vetrina PR22 in vetro riflettente fumé e profilo in alluminio anodizzato nero, mensole laccato goffrato carbone, schienali in noce c. Colonne con ante in laccato goffrato glacier white. Sotto: dettaglio della particolare lavorazione che caratterizza l'apertura del modello Phoenix. Cassetto in massello noce canaletto con sistema di illuminazione interna a led. Attrezzatura in wengé e acciaio con tagliere per pane e contenitori in ceramica.

This and previous pages: base units with doors, drawers and pull-out storage baskets in walnut canaletto solid wood, top in scotch brite steel Barazza. Island-hoods in scotch brite steel. Wall units with fumé reflecting glass doors and black anodized aluminium profile PR22, shelves in embossed lacquered carbone, back panels in walnut c. Tall units with doors in embossed lacquered glacier white. Below: close-up of the special workmanship characterising the Phoenix model handle. Drawer in solid wood walnut canaletto, with inner led lighting system. Inner equipment in wenge and steel with chopping board and containers in ceramic.





A sinistra: basi con ante, cassetti ed estrattori in massello noce canaletto e sagoma frontale laccato opaco acciaio. Top in acciaio scotch brite Barazza con lavello in acciaio scotch brite saldato, piano cottura in vetroceramica a induzione con piastra Teppan Yaki. Sotto: dettaglio della presa elettrica da piano a scomparsa.

To the left: base units with doors, drawers and pull-out storage baskets in solid wood walnut canaletto and front profile in mat lacquered steel. Top in scotch brite steel Barazza with soldered sink in scotch brite steel, glass ceramic induction hob and Teppan Yaki griddle. Below: close-up view of lift-up power socket.









Qui e nelle pagine precedenti: basi con ante, cassetti ed estrattori in massello noce canaletto, top in acciaio scotch brite Barazza. Cappe a isola in acciaio scotch brite. Colonne con ante in laccato goffrato glacier white. Pensili con ante vetrina PR22 in vetro riflettente fumé e profili in alluminio anodizzato nero, mensole in laccato goffrato carbone e schienali in noce c. Tavolo Blade in massello noce canaletto, sedie Seattle con seduta in cuoio 26 invecchiato e struttura in rovere naturale. Sotto: dettaglio delle ante vetrina PR22 con apertura pieghevole in vetro riflettente fumé e profilo in alluminio anodizzato nero.

This and previous pages: base units with doors, drawers and pull-out storage baskets in solid wood walnut canaletto, top in scotch brite steel Barazza. Island-hoods in scotch brite steel. Tall units with doors in embossed lacquered glacier white. Wall units with fumé reflecting glass doors and black anodized aluminium profiles PR22, shelves in embossed lacquered carbone, back panels in walnut c. Blade table with structure and top in solid wood walnut canaletto. Seattle chairs, legs in natural oak and seat in hide 26 invecchiato. Below: close-up of folding doors PR22 in fumé reflecting glass with black anodized profiles.



**PHOENIX**  
Design R&D Poliform

**Basi p 1280**  
Strutture: nobilitato grigio lavagna.  
Ante, cassetti ed estrattori: massello noce canaletto.  
Maniglie: sagoma laccato opaco acciaio.  
Fianchi: acciaio scotch brite, spessore 6 mm.  
Top: acciaio scotch brite Barazza, spessore 6 mm.  
Zoccoli: laccato opaco acciaio.

**Colonne p 640**  
Strutture: nobilitato grigio lavagna.  
Ante: laccato gofrato glacier white.  
Maniglie: distanziatore verticale e sagoma orizzontale laccato opaco acciaio.  
Fianchi: laccato gofrato glacier white, spessore 26 mm.  
Zoccoli: laccato opaco acciaio.

**Pensili p 410**  
Strutture: nobilitato grigio lavagna.  
Ante vetrina PR22: profilo alluminio anodizzato nero e vetro riflettente fumé.  
Maniglie: profilo.  
Fianchi: laccato gofrato carbone, spessore 6 mm.  
Mensole: laccato gofrato carbone, spessore 30 mm.  
Schienali: noce c.

**Complementi**  
Tavolo Blade: struttura e piano in massello noce canaletto.  
Sedia Seattle: seduta in cuoio 26 invecchiato, gambe rovere naturale.

**Base units d 50 1/2"**  
Structures: grey lavagna melamine.  
Doors, drawers and pull-out storage baskets: solid wood walnut canaletto.  
Handles: profile in mat lacquered steel.  
Side panels: scotch brite steel, thickness 1/4".  
Top: scotch brite steel Barazza, thickness 1/4".  
Plinths: mat lacquered steel.

**Tall units d 25 1/4"**  
Structures: grey lavagna melamine.  
Doors: embossed lacquered glacier white.  
Handles: vertical spacer and horizontal profile in mat lacquered steel.  
Side panels: embossed lacquered glacier white, thickness 1".  
Plinths: mat lacquered steel.

**Wall units d 16 1/4"**  
Structures: grey lavagna melamine.  
Glass doors PR22: black anodized aluminium profile and fumé reflecting glass.  
Handles: profilo.  
Side panels: embossed lacquered carbone, thickness 1/4".  
Shelves: embossed lacquered carbone, thickness 1 1/4".  
Back panels: walnut c.

**Accessories**  
Blade table: structure and top in solid wood walnut canaletto.  
Seattle chair: seat in hide 26 invecchiato and natural oak legs.

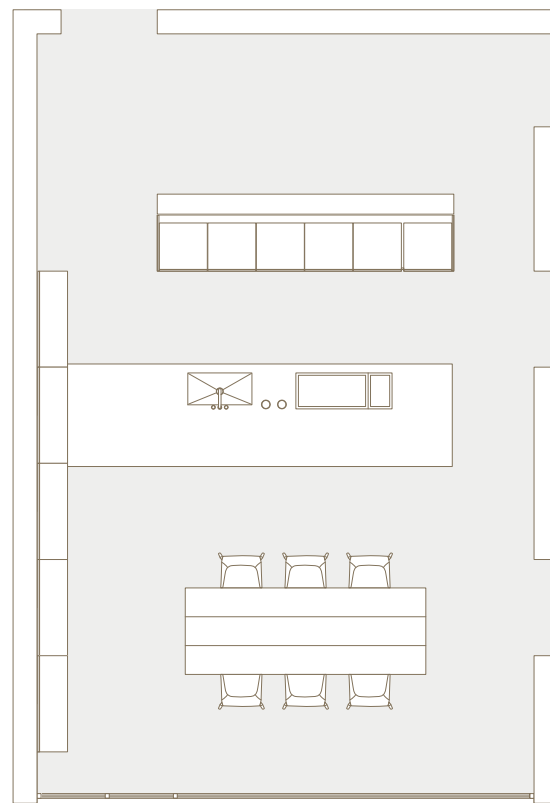
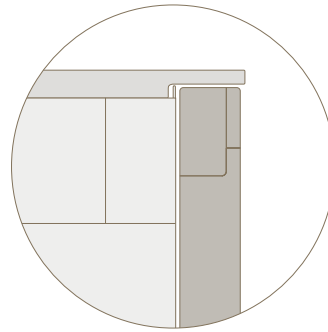

**Basi**  
**Base units**

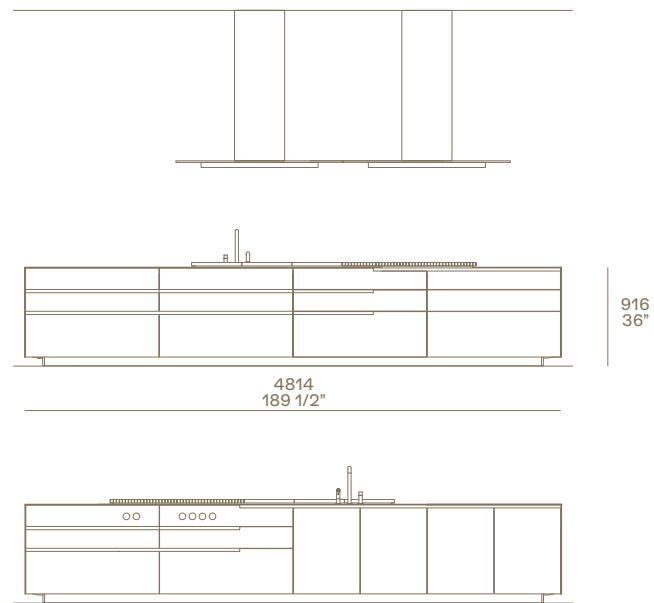

**Colonne**  
**Tall units**

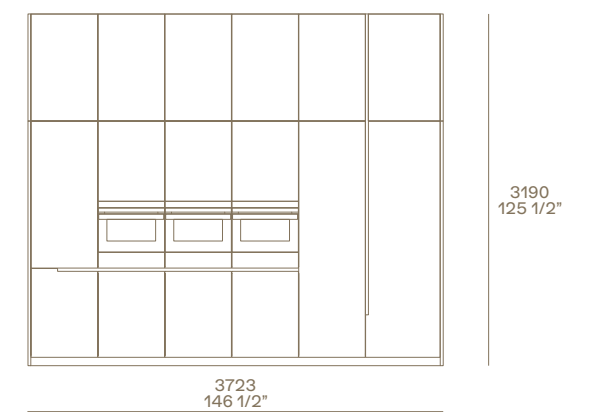

**Pensili**  
**Wall units**

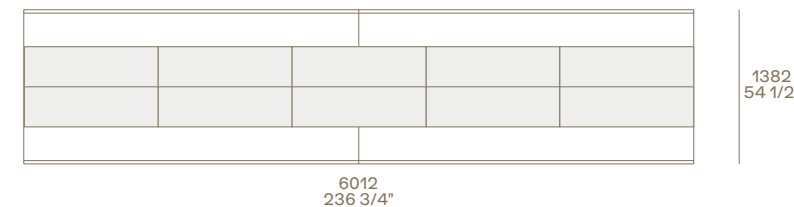

**Seattle**  
Design Jean-Marie Massaud

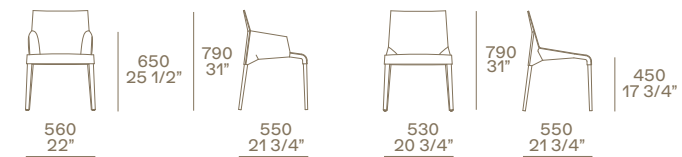

**Blade**  
Design R&D Poliform



- 1 Piano cottura a induzione in vetroceramica e piastra Teppan Yaki, incasso filotop.
- 2 Lavello in acciaio scotch brite saldato.
- 3 Prese elettriche a scomparsa.
- 4 Attrezzatura cassetti in wengé e acciaio.

- 5 Attrezzatura in wengé e acciaio per estrattori.
- 6 Cappe a isola in acciaio scotch brite.
- 7 Pensili con ante vetrina PR22 con apertura pieghevole.

- 8 Colonne con forno, scaldavivande e frigo/congelatore con ante ad apertura battente ed estrattori.
- 9 Attrezzatura in wengé e acciaio per estrattori.

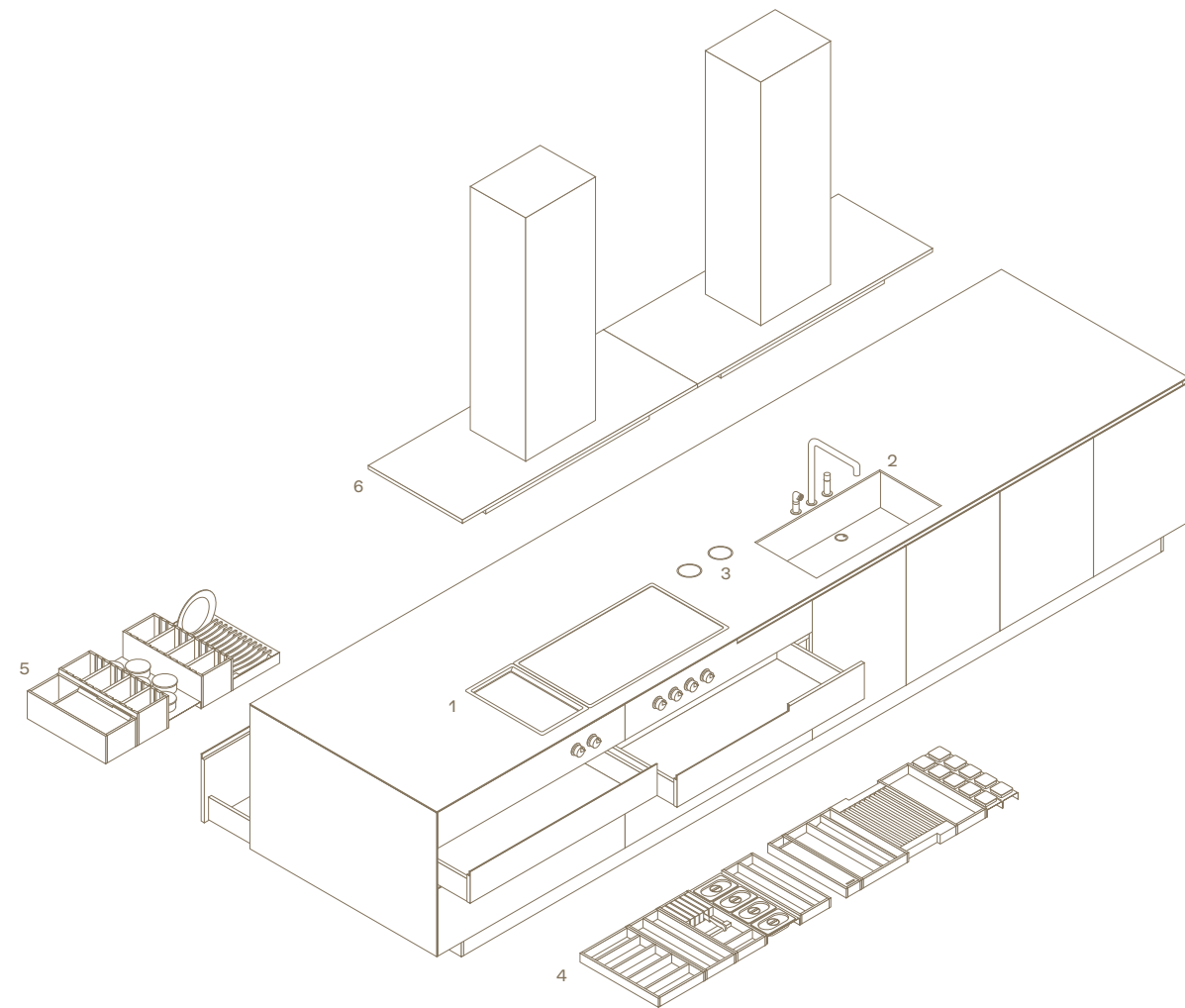

- 1 Glass ceramic induction hob and Teppan Yaki griddle, flush built-in.
- 2 Soldered sink in scotch brite steel.
- 3 Lift-up power socket.
- 4 Equipment in wenge and steel for drawers.

- 5 Equipment in wenge and steel for pull-out storage basket.
- 6 Island-hoods in scotch brite steel.
- 7 Wall units with glass doors PR22 with folding opening.

- 8 Tall units with oven, plate warmer and fridge/freezer with leaf doors and pull-out storage baskets.
- 9 Equipment in wenge and steel for pull-out storage baskets.

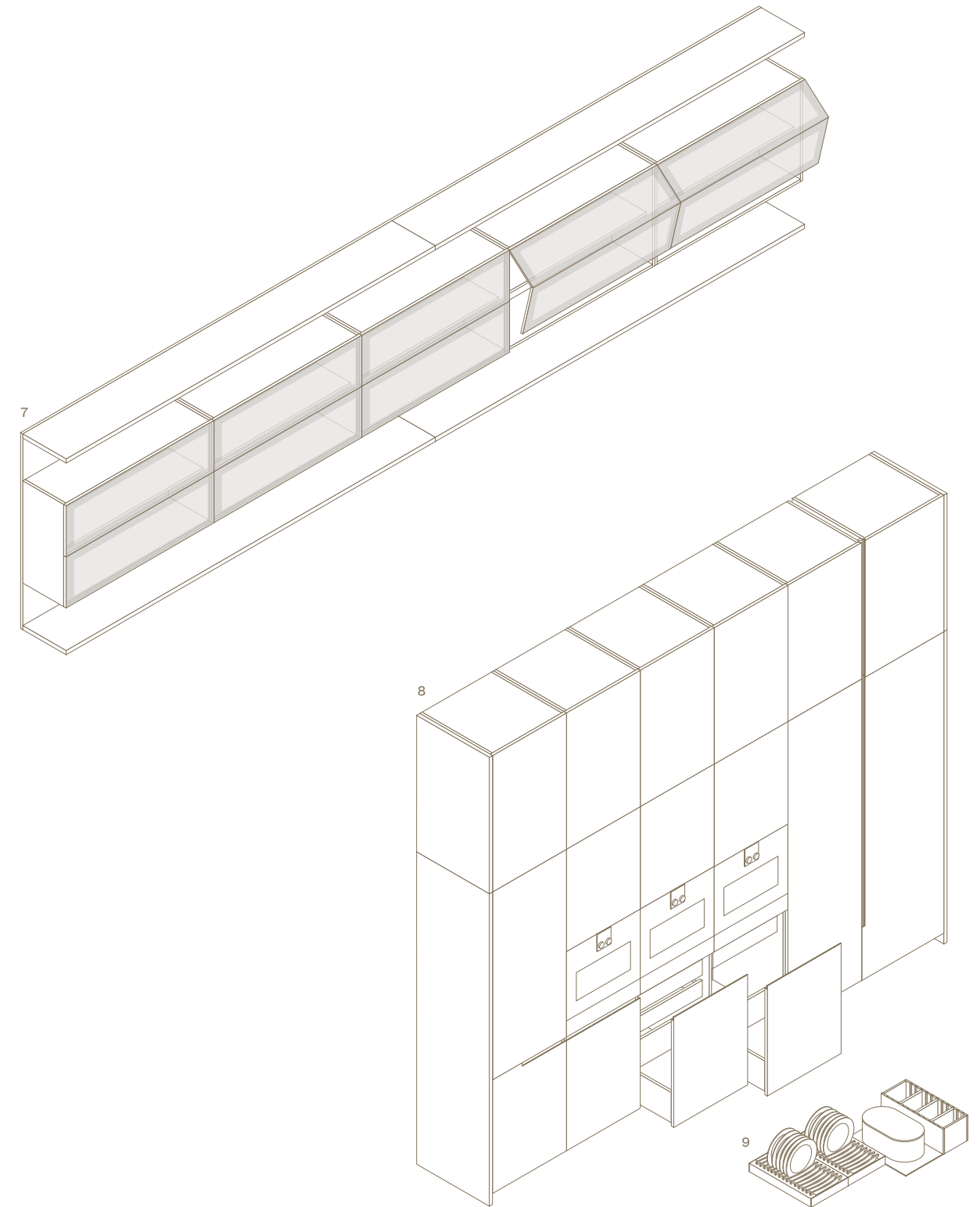

**PHOENIX**  
Design R&D Poliform

**Spessore anta**  
26 mm.  
Maniglia integrata.

**Finiture anta**  
Laccato lucido 18 colori.  
Laccato goffrato 23 colori.  
Laccato metallico 4 colori.  
5 essenze.  
Massello noce canaletto.  
Massello rovere termico.  
Massello rovere fossile.  
Massello black ash.  
DuPont Corian® glacier white.  
Acciaio scotch brite.

**Door thickness**  
26 mm - 1".  
Built-in handle.

**Door finishings**  
Glossy lacquered 18 colours.  
Embossed lacquered 23 colours.  
Metallic lacquered 4 colours.  
5 woods.  
Solid walnut canaletto.  
Solid thermic oak.  
Solid fossil oak.  
Solid black ash.  
DuPont Corian® glacier white.  
Steel scotch brite.

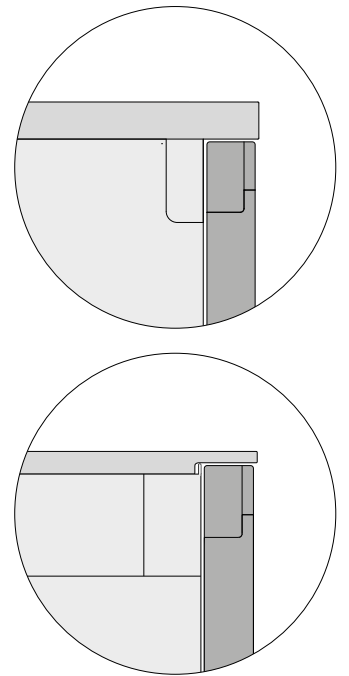

## VETRINE SHOWCASES

### PR19

Spessore 26 mm.  
Anta in vetro riflettente 5051 bronzato  
con telaio in alluminio verniciato bronzo.  
Per pensili apertura con profilo inferiore  
o apertura tip-on.  
Thickness 26 mm - 1".  
Door in bronzed reflecting glass 5051  
with frame in bronzo painted aluminium.  
For wall units with opening with lower  
profile or tip-on opening.



### PR22

Spessore 20 mm.  
Anta in vetro riflettente 5059 fumé  
con telaio alluminio anodizzato nero.  
Per pensili apertura con profilo inferiore.  
Per colonne apertura con distanziale  
o con maniglia integrata verniciato nero.  
Per elementi sopra colonna apertura  
con distanziale o apertura tip-on.  
Thickness 20 mm - 3/4".  
Door in fumé reflecting glass 5059 with  
black anodized aluminium frame.  
For wall units with opening with lower profile.  
For tall units with opening with spacer or  
with black painted integrated handle.  
For elements above tall unit with opening  
with spacer or tip-on opening.



### PR21

Spessore 26 mm.  
Anta in vetro riflettente 5059 fumé  
con telaio in alluminio anodizzato moka.  
Per pensili apertura con profilo inferiore.  
Per colonne apertura con maniglia  
integrata verniciato moka.  
Per elementi sopra colonna apertura tip-on.  
Thickness 26 mm - 1".  
Door in fumé reflecting glass 5059 with  
moka anodized aluminium frame.  
For wall units with opening with lower profile.  
For tall units with opening moka painted  
integrated handle.  
For elements above tall unit with tip-on  
opening.



## ATTREZZATURA CASSETTI DRAWERS EQUIPMENTS

### Tipologie

- 1 Cassetti.
- 2 Cassetti interni estraibile.
- 3 Cassetti interni anta.

### Accessori

Portaposate, portacoltelli, bilancia elettronica, tagliere per pane, portaspezie in ceramica, vaschette in acciaio, set macinaspezie, portapelliole, portamattarello.

### Types

- 1 Drawers.
- 2 Pull-out baskets.
- 3 Leaf door with inner drawers.

### Accessories

Cutlery tray, knife-rack, electronic scale, chopping board for bread, ceramic spice-holder, steel basins, spice grinder set, protective-film rack, rolling pin-holder.

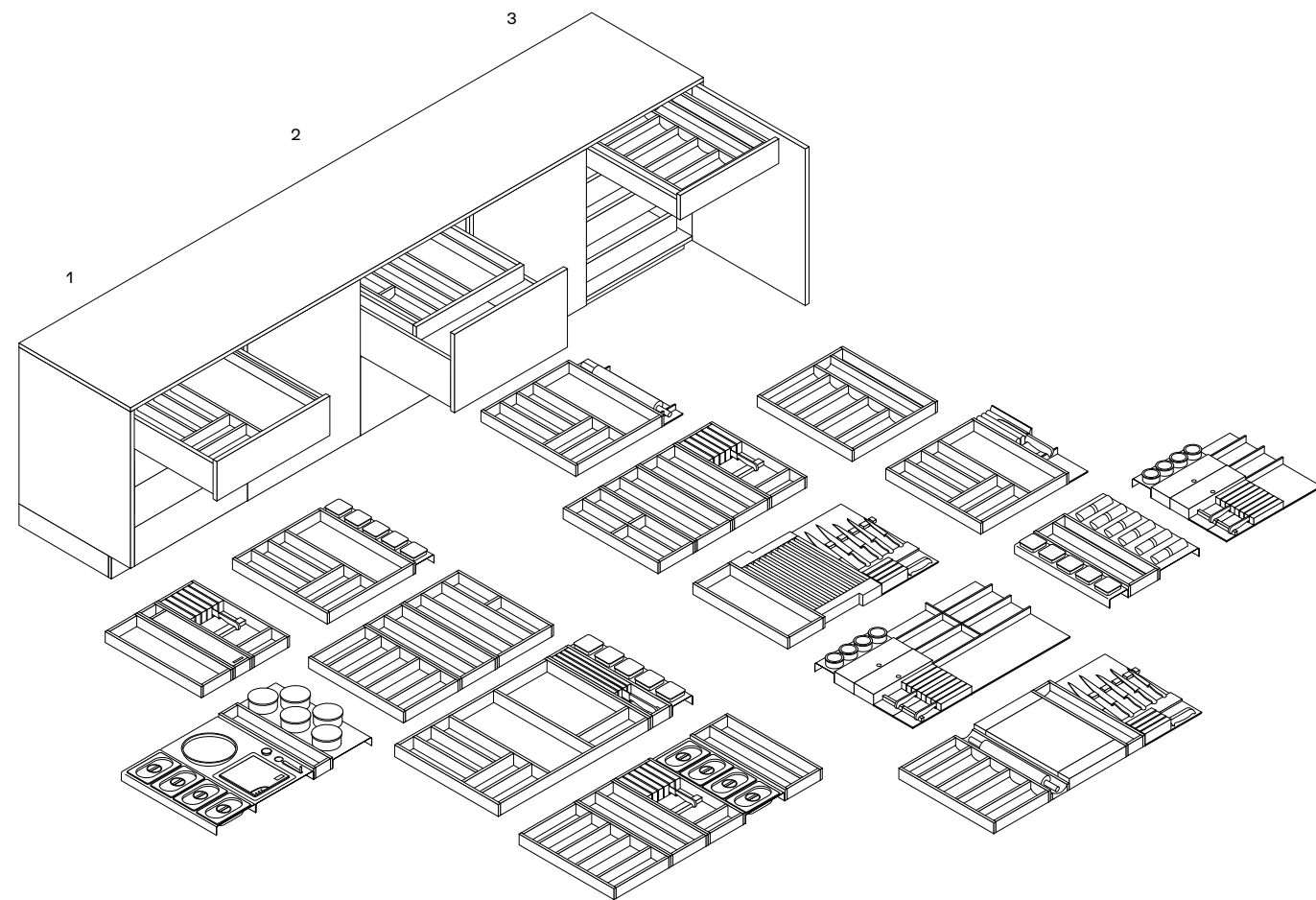

### Attrezzature Equipments



Wengé  
Wenge



Noce canaletto  
Walnut canaletto



Laminato military touch  
Laminate military touch



Alluminio  
Aluminium



Materiale plastico  
atossico antracite  
Non-toxic plastic  
colour antracite

## ATTREZZATURA ESTRATTORI PULL-OUT BASKETS EQUIPMENTS

### Tipologie

- 1 Base 1 estraibile e 2 cassetti.
- 2 Base 2 estraibili.
- 3 Base 1 estraibile unico e 1 estraibile interno.

### Accessori

Piattaia, portapiatti regolabile, barattoli portapasta in acciaio, portapane in terracotta, portaspezie in ceramica, portarotolo, contenitori in ceramica, contenitori in acciaio.

### Types

- 1 Base unit 1 pull-out basket and 2 drawers.
- 2 Base unit 2 pull-out baskets.
- 3 Base unit 1 pull-out basket and 1 inner pull-out basket.

### Accessories

Plate-rack, adjustable plate-rack, kit pasta-holders in steel, clay bread container, ceramic spice-holder, rolling pin-holder, ceramic holders, steel holders.

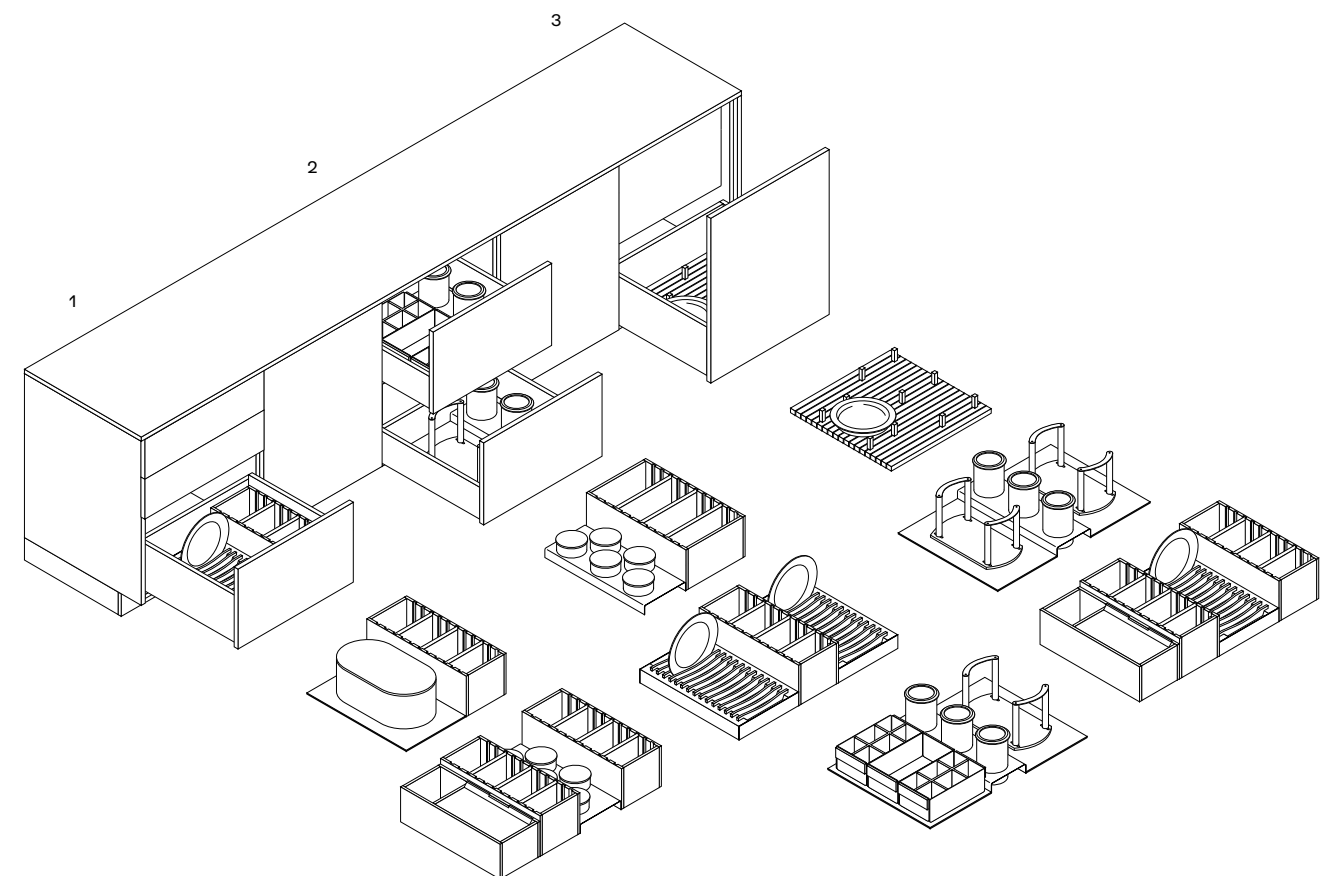

### Attrezzature Equipments



Wengé  
Wenge



Noce canaletto  
Walnut canaletto



Laminato military touch  
Laminate military touch



Alluminio  
Aluminium

## COLONNE ATTREZZATE EQUIPPED TALL UNITS

### Tipologie

- 1 Colonna con struttura estraibile Tandem.
- 2 Colonna con struttura estraibile Convoy Lavido.
- 3 Colonna con struttura estraibile Convoy Centro.
- 4 Colonna attrezzata con ganci portascoppe e cestelli.

### Types

- 1 Tall unit with Tandem extractable equipment.
- 2 Tall unit with Convoy Lavido extractable equipment.
- 3 Tall unit with Convoy Centro extractable equipment.
- 4 Tall unit with broom-holders and storage baskets.

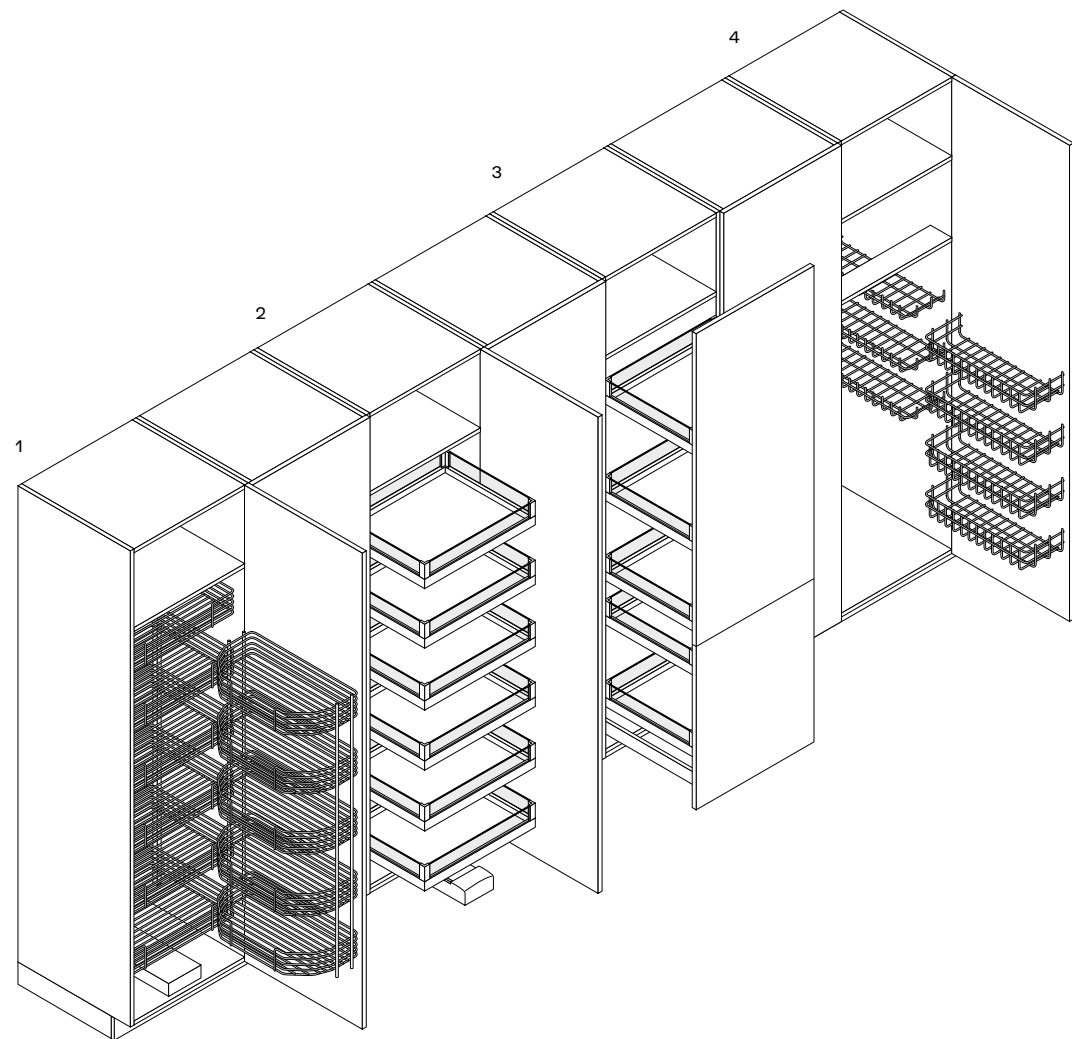

## VANI ATTREZZATI EQUIPPED UNITS

### Tipologie

- 1 Ante battenti apertura totale.
- 2 Ante a scomparsa.

### Attrezzature

Piano di lavoro estraibile in acciaio o essenza, barra con lampade e presa elettrica, cassetti interni, ripiani, ripiani in vetro, Shaker e Deep Shaker, luce led.

### Types

- 1 Total opening leaf door.
- 2 Pocket doors.

### Equipments

Extractable worktop in steel or woods, light cover bar with lamp and socket, internal drawers, shelves, shelves in glass, Shaker and Deep Shaker, led lighting.

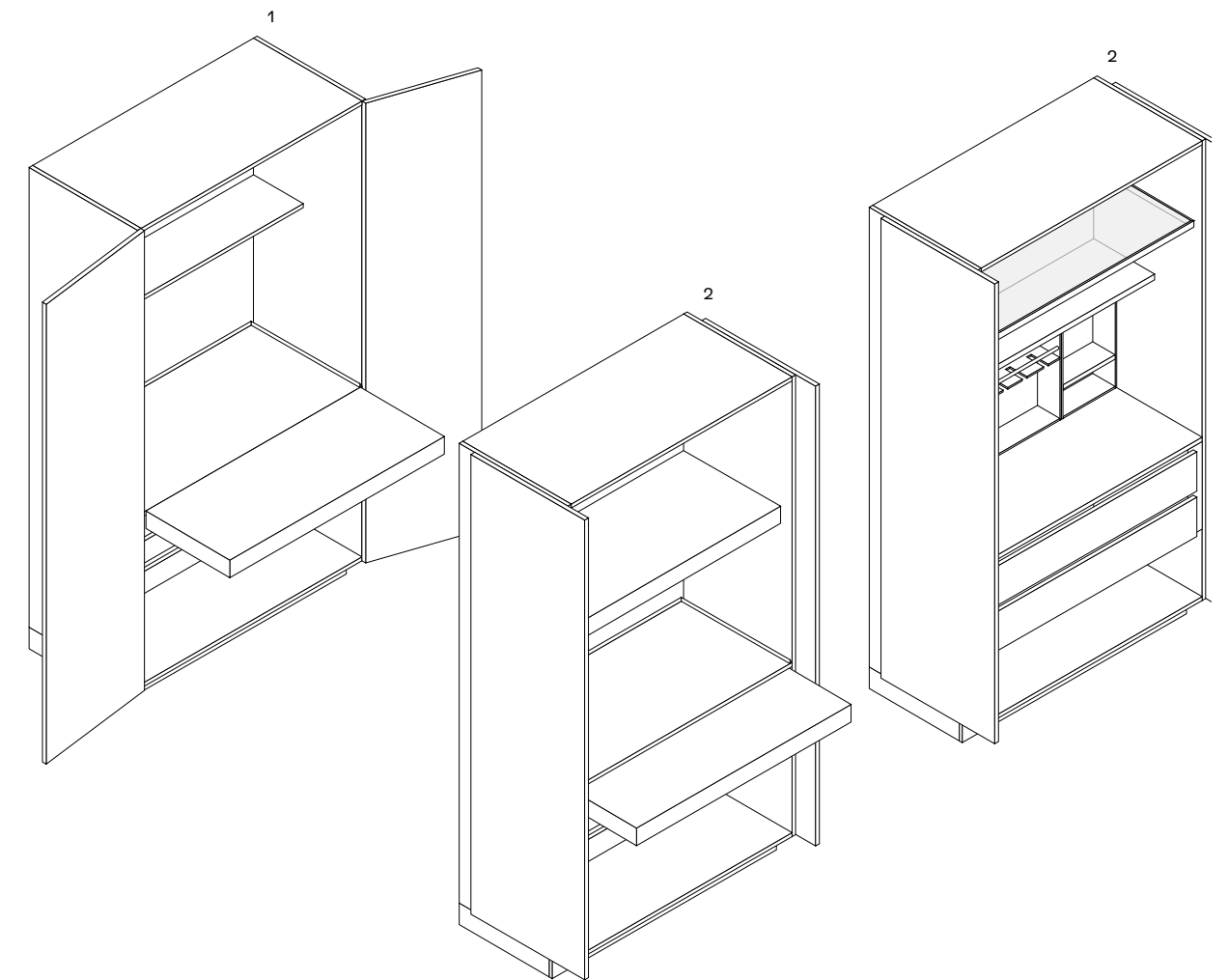

COLONNE CON VANI A GIORNO  
OPEN TALL UNITS

**Tipologie**

- 1 Colonna a giorno con ripiani.
- 2 Colonna a giorno con cestelli in midollino.
- 3 Colonna a giorno Trail.

**Types**

- 1 Open tall unit with shelves.
- 2 Open tall unit with wicker baskets.
- 3 Trail open tall unit.

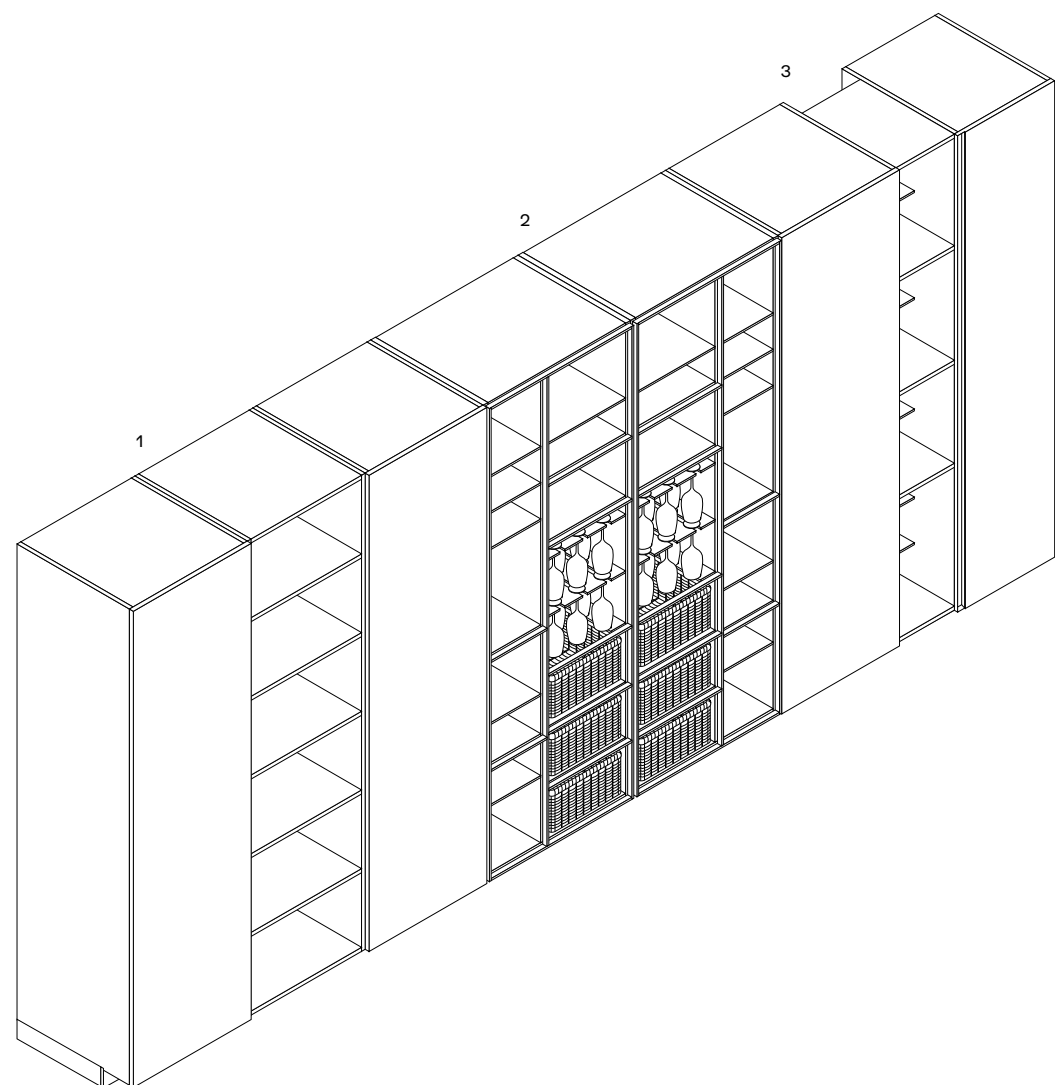

DEEP SHAKER E SHAKER SCHIENALI MODULARI  
DEEP SHAKER AND SHAKER MODULAR BACKS

**Deep Shaker - profondità 160**  
**Shaker - profondità 120**

Schienali modulari disponibili in diverse dimensioni e configurazioni. Moduli larghezza da 300 a 1200.

- 1 Moduli sopratop, misure variabili in riferimento allo spessore del top. Moduli Shaker h 600. Moduli Deep Shaker h 600-720-840.
- 2 Moduli a terra, Shaker e Deep Shaker h 1380-1440.

**Deep Shaker attrezzature**

Ripiani, tubi, contenitori in DuPont Corian®, porta spezie, porta coltelli, porta tablet, griglia, porta bicchieri, cassettoni in noce canalotto, barattoli in ceramica o in vetro, canalina elettrificata. Anta a ribalta con porta spezie, barattoli in ceramica o attrezzatura elettrica.

**Shaker attrezzature**

Ripiani, tubi, contenitori in DuPont Corian®, griglia, porta bicchieri.

**Deep Shaker - depth 6 1/4"**  
**Shaker - depth 4 3/4"**

Modular backs available in different sizes and configurations. Modules width from 11 3/4" to 47 1/4".

- 1 Module above worktop, sizes according to the worktop thickness. Shaker modules h 23 1/2". Deep Shaker modules h 23 1/2"-28 1/4"-33".
- 2 Floorstanding modules, Shaker and Deep Shaker h 54 1/4"-56 3/4".

**Deep Shaker accessories**

Shelves, bars, containers in DuPont Corian®, spice holders, knife-rack, tablet holder, little drawers in walnut canaletto, ceramic or glass jars, powered conduit. Flap door with spices holder, ceramic jars or electric accessories.

**Shaker accessories**

Shelves, bars, containers in DuPont Corian®, grid, glass holders.

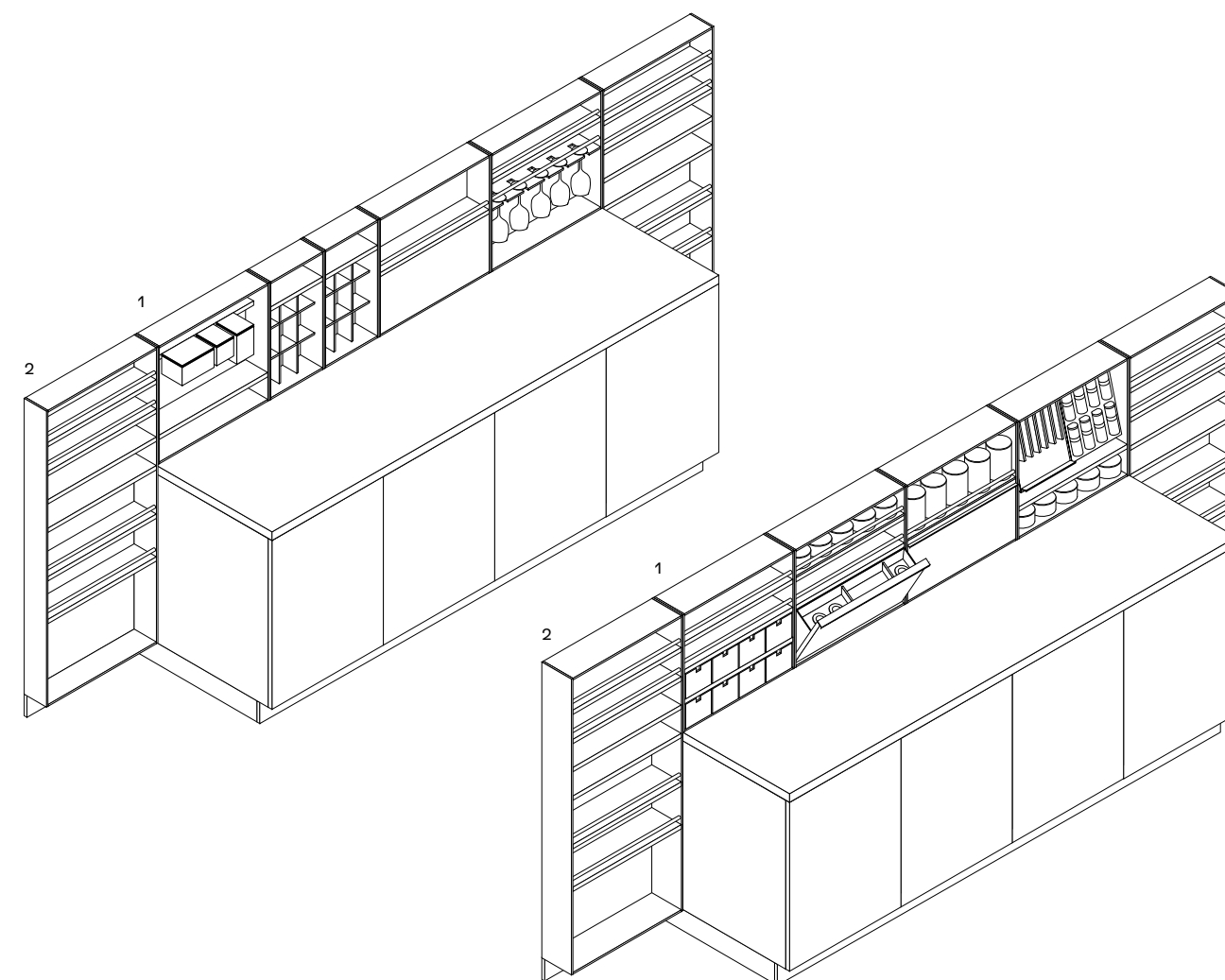



## SOLUZIONI PER ANGOLI CORNER SOLUTIONS

### Basi

- 1 Base doppio battente.
- 2 Base anta battente.

### Pensili

- 3 Pensile anta battente.
- 4 Pensile anta pieghevole.
- 5 Pensile doppio battente.

### Colonne

- 6 Colonna doppio battente.
- 7 Colonna anta battente.

### Attrezzature

- 8 Cesti estraibili LeMans.
- 9 Cestelli in metallo cromato.

### Base units

- 1 Base unit with two leaf doors.
- 2 Base unit with leaf door.

### Wall units

- 3 Wall unit with leaf door.
- 4 Wall unit with folding door.
- 5 Wall unit with two leaf doors.

### Tall units

- 6 Tall unit with two leaf doors.
- 7 Tall unit with leaf door and inner shelves.

### Equipments

- 8 Pull-out storage baskets LeMans.
- 9 Baskets in chromed metal.

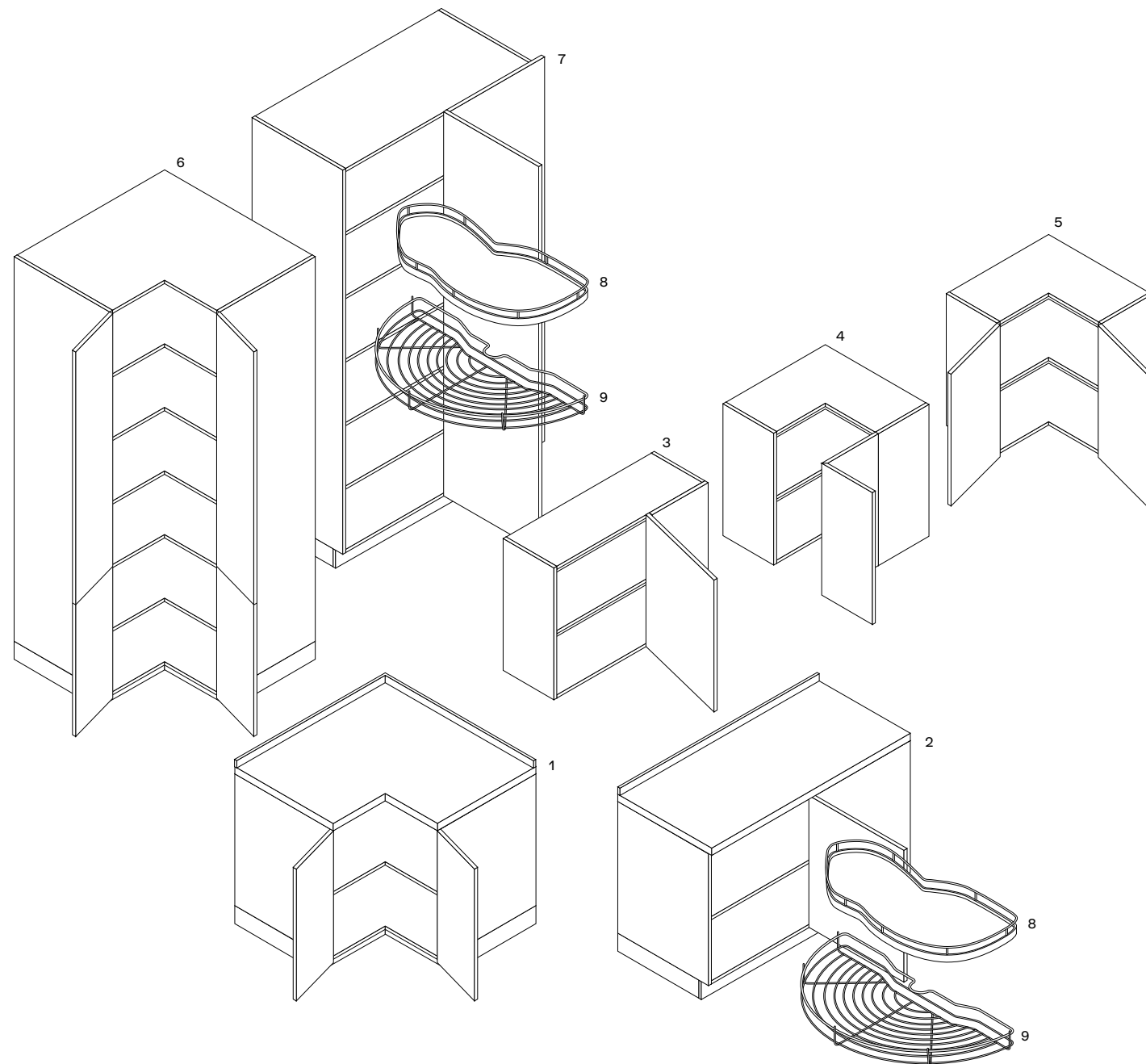

## COLONNE HIGH HIGH TALL UNITS

Il sistema colonne High, disponibile per i modelli Shape, Artex, Phoenix e Trail, prevede la sovrapposizione di singoli fusti e il montaggio di un'anta intera o di due ante divise. Nel caso di ante divise, il taglio delle ante è situato sempre nella parte inferiore, a 840 mm dal filo inferiore della colonna. Lo zoccolo previsto è di 70 o 100 mm. Anta intera non disponibile nella versione in massello.

- 1 Colonna anta intera  
h 2710-2740, anta h 2640  
h 2830-2860, anta h 2760.
- 2 Colonna anta intera a scomparsa  
h 2710-2740, anta h 2640.
- 3 Colonna con ante divise  
h 2710-2740, ante h 840+1800  
h 2830-2860, ante h 840+1920  
h 2950-2980, ante h 840+2040.

The tall unit system High, available for the models Shape, Artex, Phoenix and trail, consists of two superimposed elements and a full height door or two separate doors. In case of separate doors, the separation of the doors is always in the lower part, 33" from the lower edge of the tall unit. The plinth is foreseen in h 3/4" or 4". The full height door is not available in solid wood finish.

- 1 Tall unit with full height door  
h 106 3/4"-107 3/4", door h 104"  
h 111 1/2"-112 1/2", door h 108 3/4".
- 2 Tall unit with full height pocket door  
h 106 3/4"-107 3/4", door h 104".
- 3 Tall unit with separate doors  
h 106 3/4"-107 3/4", doors h 33"+70 3/4"  
h 111 1/2"-112 1/2", doors h 33"+75 1/2"  
h 116 1/4"-117 1/4", doors h 33"+80 1/4".

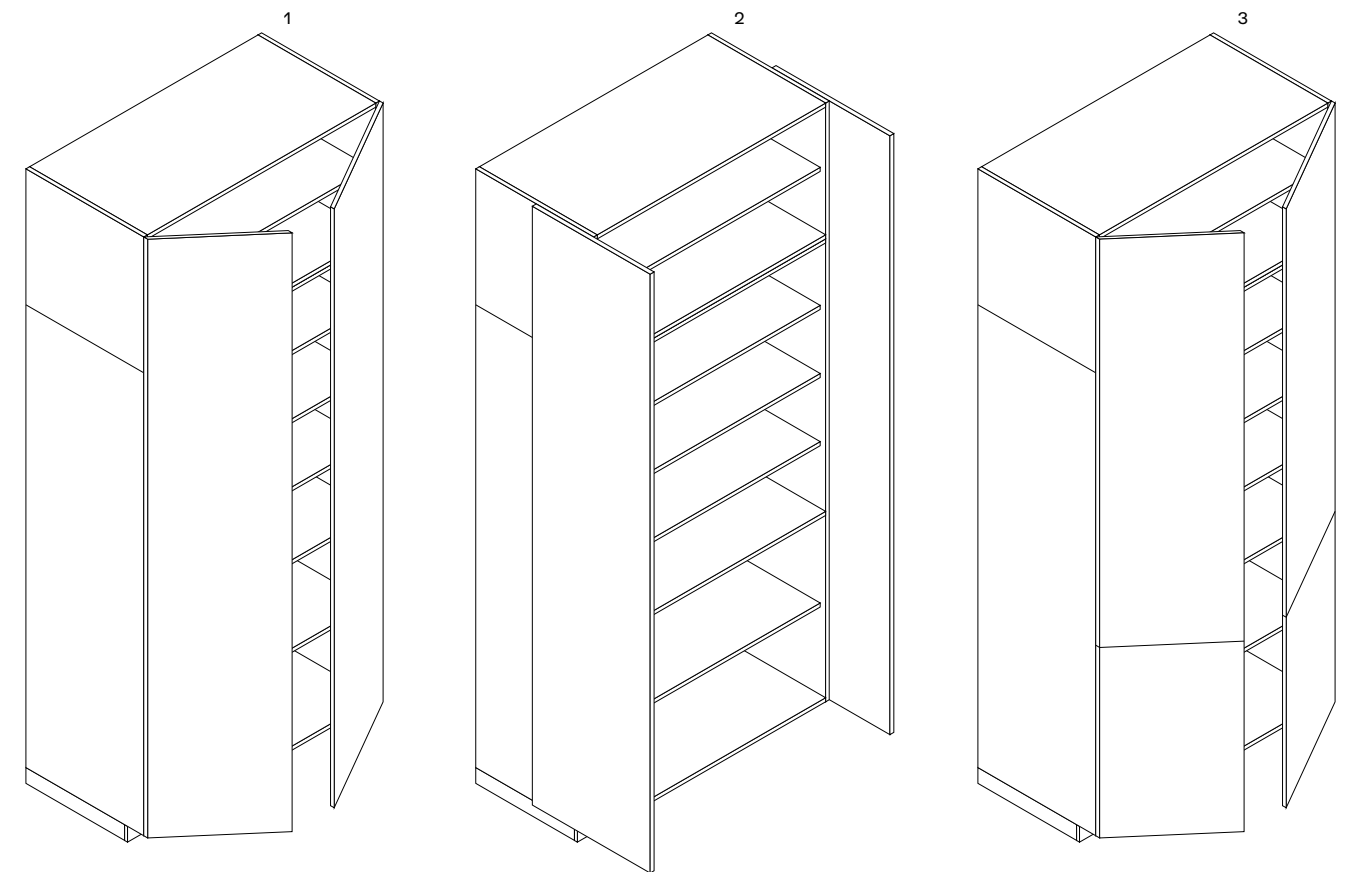

## PIANI COTTURA HOBS

### Tipologie

- 1 Piano a gas.
- 2 Piano a induzione.
- 3 Elementi modulari.

### Tipologie di incasso

Incasso standard: il piano sporge da 4 a 15 mm; semifilotop: bordo inclinato di 3 mm; finotop: il piano sporge 1 mm; filotop. Nel caso di piani di lavoro in acciaio, i piani cottura possono essere saldati direttamente nella superficie del top.

### Types

- 1 Gas hob.
- 2 Induction hob.
- 3 Modular elements.

### Built-in types

Standard built-in with jutting hob of 1/4" a 1/2"; semi-flush built-in with inclined edge of 1/8"; flush built-in with jutting hob 5/128" and fully flush built-in. In case of steel worktops, the hobs can be soldered directly in the worktop.

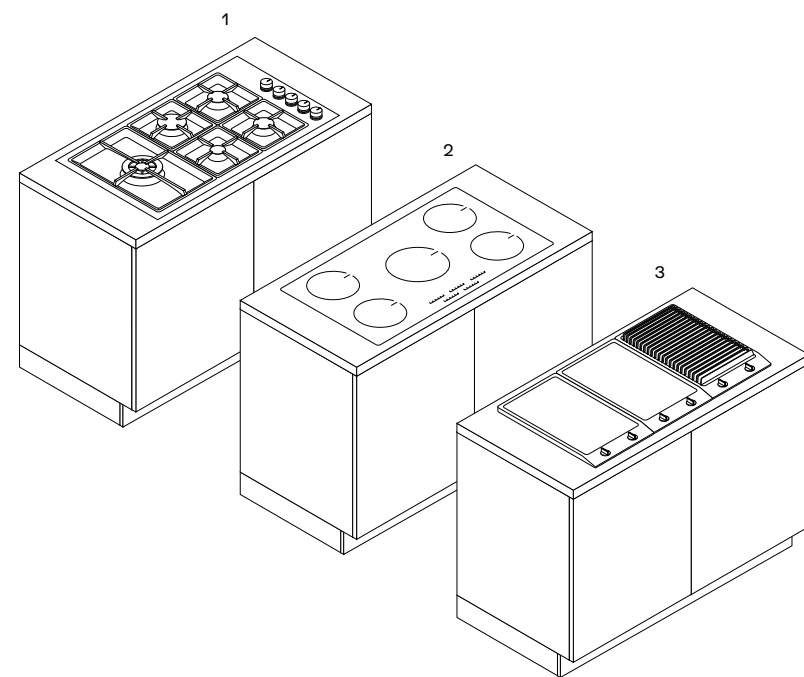

### Tipologie di incasso Built-in types

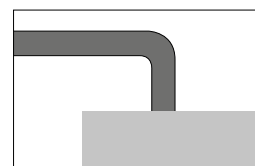

Standard  
Standard built-in

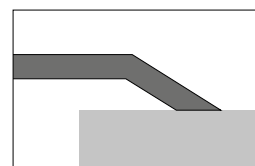

Semifilotop  
Semi-flush built-in

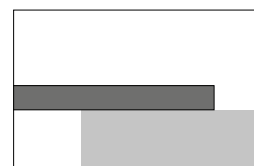

Finotop  
Flush built-in

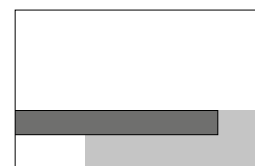

Filotop  
Fully flush built-in

## LAVELLI SINKS

### Tipologie

- 1 Vasca singola.
- 2 Vasca e gocciolatoio.
- 3 Vasca grande e piccola.
- 4 Vasca grande, piccola e gocciolatoio.
- 5 Due vasche.
- 6 Due vasche e gocciolatoio.

### Types

- 1 Single basin.
- 2 Basin with drip.
- 3 Big and small basins.
- 4 Big and small basins with drip.
- 5 Two basins.
- 6 Two basins with drip.

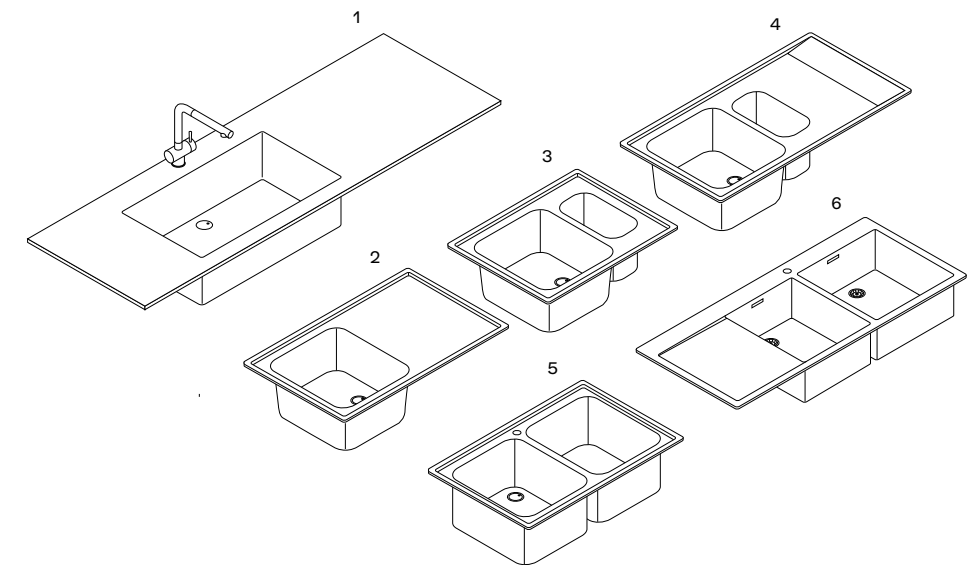

### Tipologie di incasso Built-in types



Appoggio h 40 mm  
Surface-mounted h 1 1/2"

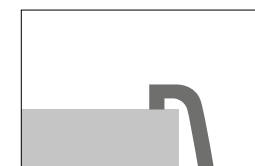

Incasso  
Standard built-in

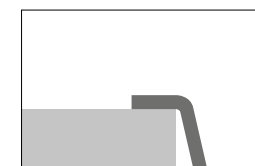

Finotop  
Flush built-in

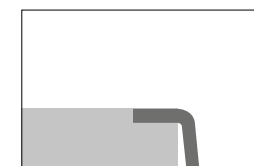

Filotop  
Fully flush built-in

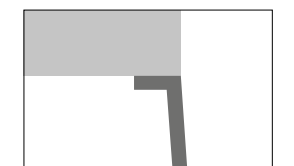

Sottotop  
Under-top mounted

## CAPPE HOODS

### Infinity, sistema modulare

Moduli personalizzati Poliform da assemblare per configurazioni a isola con illuminazione led integrata.

- 1 Modulo aspirante luminoso  
| 1050-1200-1500 con carter da 450  
| 1800-2400 con carter da 600.
- 2 Modulo fitostimolante luminoso  
con teca in vetro bassa o alta  
| 600-750-900.
- 3 Modulo luminoso con teca in  
vetro bassa o alta  
| 600-750-900.
- 4 Modulo luminoso  
| 600-750-900-1050-1200.

### Infinity, modular system

Poliform personalized modules to be assembled for island configurations with integrated led light.

- 1 Lighted suction module  
| 41 1/4"-47 1/4"-59" with carter of 17 3/4"  
| 70 3/4"-92 1/2" with carter of 23 1/2".
- 2 Phytostimulant lighted module  
with low or high glass case  
| 23 1/2"-29 1/2"-35 1/2".
- 3 Lighted module with low or  
high glass case  
| 23 1/2"-29 1/2"-35 1/2".
- 4 Lighted module  
| 23 1/2"-29 1/2"-35 1/2"-41 1/4"-47 1/4".

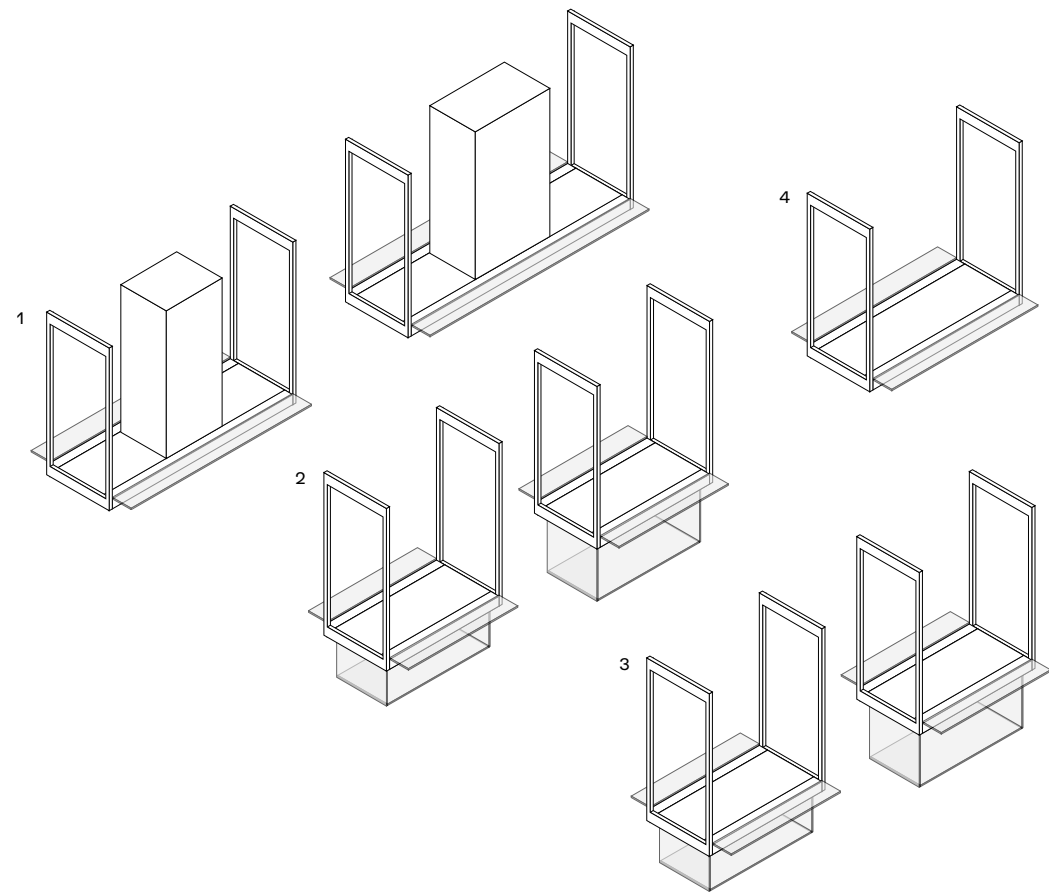

### Cappe personalizzate Poliform

- 1 Cappa Piatta a parete e a isola.
- 2 Cappa Factory a isola.
- 3 Cappa Flat a parete e a isola.
- 4 Cappa Box a parete e a isola.
- 5 Cappa Glass a isola.
- 6 Cappa Work a parete e a isola.

### Poliform personalised hoods

- 1 Piatta wall mounted, island-hood.
- 2 Factory island-hood.
- 3 Flat wall mounted, island-hood.
- 4 Box wall mounted, island-hood.
- 5 Glass island-hood.
- 6 Work wall mounted, island-hood.

### Cappe integrate

- 7 Cappa a scomparsa.
- 8 Cappa Easy integrata nel pensile,  
per piani cottura a gas o induzione.
- 9 Cappa Downdraft a scomparsa  
nel top.

### Integrated hoods

- 7 Retractable hood.
- 8 Easy built-in hood in the wall unit,  
for gas or induction hobs.
- 9 Downdraft retractable hood  
in the top.

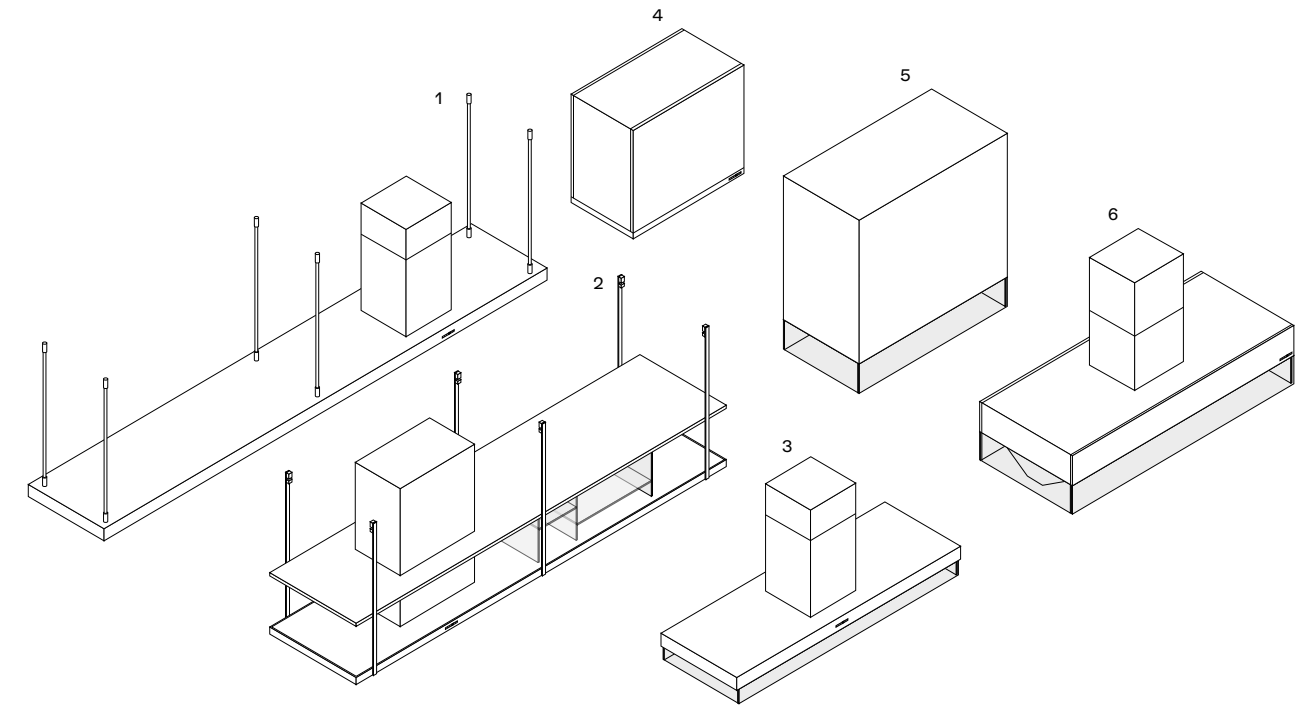

### Cappe integrate Integrated hoods

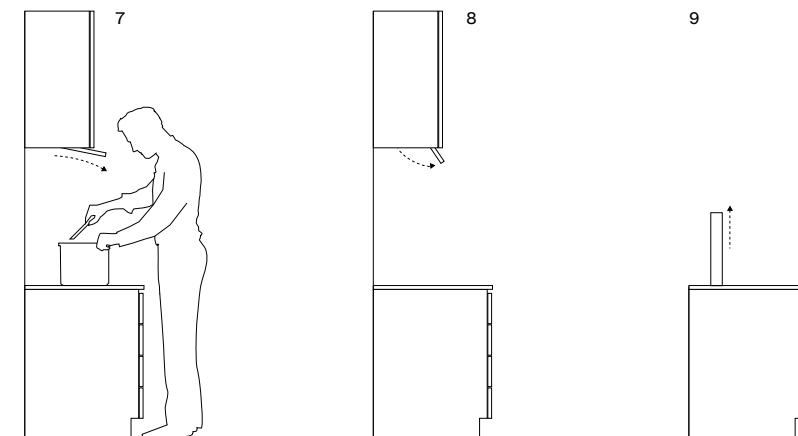

## PORTARIFIUTI WASTEBINS

### Basi con portarifiuti

- 1 Base lavello con due estrattori o estrattore unico  
1A - pattumiera raccolta differenziata T2 | 600-750-900-1050-1200 h 260.  
1B - Kit sottovasca.
- 2 Base con estrattore unico  
2A - pattumiera P-One | 450-600 h 550.
- 3 Base lavello con estrattore unico  
3A - pattumiera P-One | 600 h 360.
- 4 Base lavello con anta battente  
4A - pattumiera estraibile | 260 h 350.  
4B - pattumiere ad estrazione totale | 275-390 h 380.  
4C - pattumiera raccolta differenziata | 600-900-1200 h 360.

### Base units with waste bins

- 1 Base unit with two pull-out baskets or single basket.  
1A - waste bin for separate waste collection T2 - w 23 1/2"-29 1/2"- 35 1/2"-41 1/4"- 47 1/4" h 10 1/4"  
1B - Sink base kit.
- 2 Base unit with single pull-out basket.  
2A -waste bin P-One w 17 3/4"-23 1/2" h 21 3/4".
- 3 Sink base unit with single pull-out basket  
3A - waste bin P-One w 23 1/2" h 14 1/4".
- 4 Sink base unit with leaf door.  
4A - pull-out waste bin w 10 1/4" h 13 3/4".  
4B - waste bin with full extension glides w 10 3/4"-15 1/4" h 15".  
4C - waste bin for separate waste collection w 23 1/2"-35 1/2"-47 1/4" h 14 1/4".

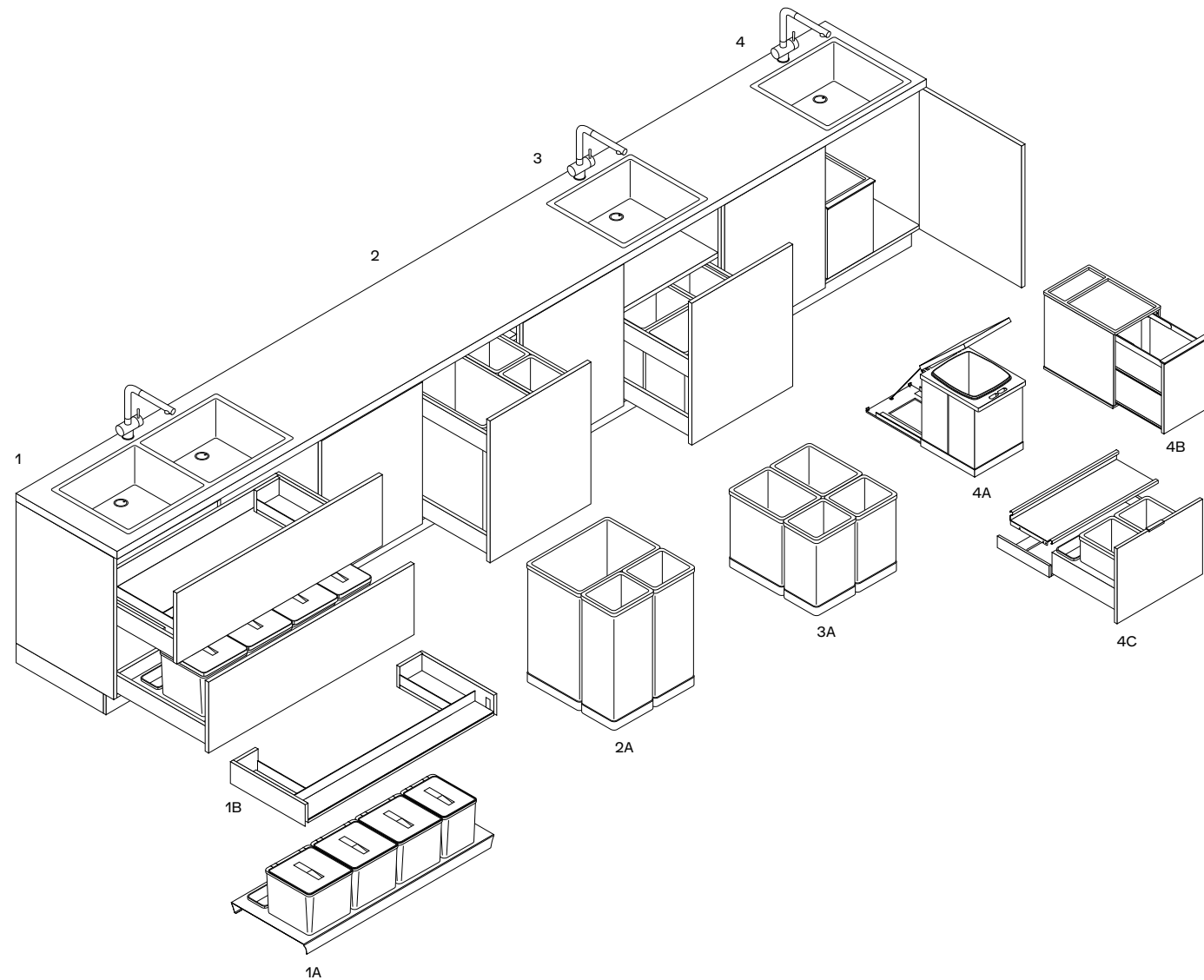

## SOLUZIONI DI ILLUMINAZIONE LIGHTING SOLUTIONS

### Illuminazione sul piano di lavoro

- 1 Sagoma con illuminazione multiled.
- 2 Faretto integrati sottopensile multiled.
- 3 Barra retrospensile multiled.
- 4 Barra sottopensile luminosa multiled.

### Lighting on worktop

- 1 Profile with multiled lighting.
- 2 Built-in multiled spotlights.
- 3 Multiled bar to the back of the wall unit.
- 4 Multiled lighted bar under wall unit.

### Multiled interno contenitori

- 5 Cassetti.
- 6 Estrattori.
- 7 Ante battenti.
- 8 Pensili.
- 9 Colonne.

### Units internal multiled

- 5 Drawers.
- 6 Pull-out baskets.
- 7 Leaf doors.
- 8 Wall units.
- 9 Tall units.

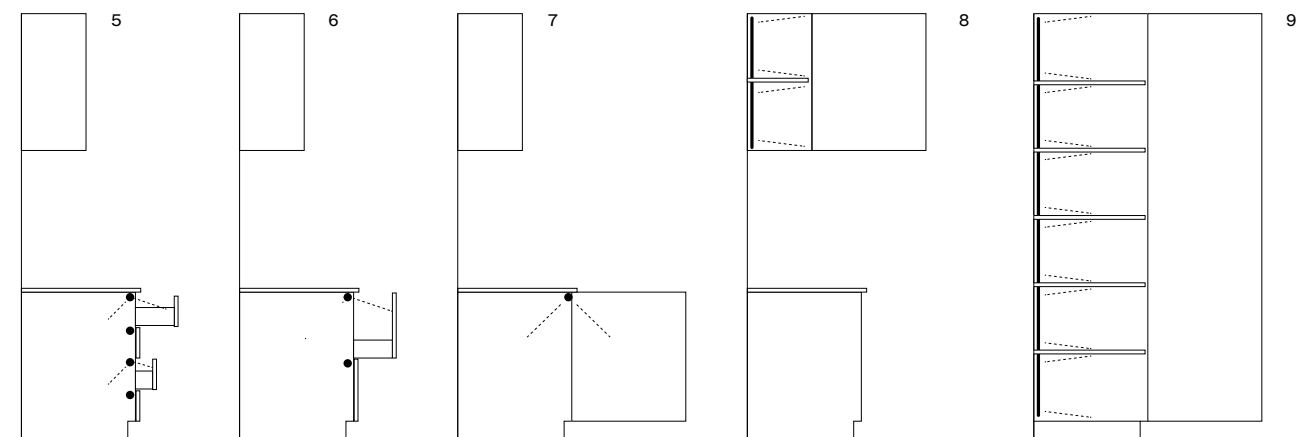
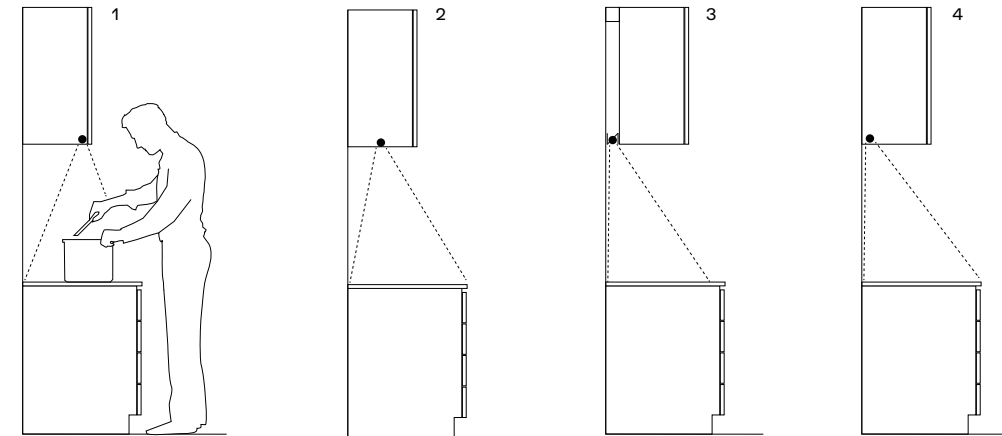

## PIANI SNACK SNACK TABLES

### Modelli e caratteristiche

- 1 Snack sp. 80 due lati folding con telaio. Da utilizzare sospeso o con gambe. Piano dogato in rovere, rovere spessart, rovere tinto grigio, rovere cenere, olmo nero, noce nazionale o massello di noce canaletto. Gambe e traversi alluminio finitura acciaio o laccato goffrato colori. l da 1800 a 2700 - passo 300 p 900-950-1050-1150-1200-1280.
- 2 Snack sp. 80 quattro lati folding. Da utilizzare sospeso o con gambe. Piano dogato in rovere, rovere spessart, rovere tinto grigio, rovere cenere, olmo nero, noce nazionale o massello di noce canaletto. Gambe cilindriche acciaio. l da 1800 a 2700 - passo 300 p 900-950-1050-1150-1200-1280.
- 3 Snack sp. 52. Da utilizzare su top sp. 6-12-20 con telaio di supporto alluminio previsto per modelli Artex, Twelve, Phoenix e Trail. Piano in rovere, rovere spessart, rovere tinto grigio, rovere cenere, olmo, olmo nero o noce c.; massello di noce nazionale, black ash o tinto olmo nero; laminato tuttocolore, laminato tuttocolore touch, laccato goffrato colori o in DuPont Corian®. Sui piani in laminato è previsto sul bordo un inserto in tinta o a contrasto nei colori dei laminati. l fino a 3000 snack laccati o legno l fino a 3600 snack in DuPont Corian® l fino a 4100 snack in laminato Sporgenza minima dalle basi 350 mm.
- 4 Snack sp. 80 a penisola quadrato. Da utilizzare su top sp. 6-12 con telaio di supporto alluminio previsto per modelli Twelve, Phoenix e Trail e sui top sp. 20. Piano dogato e gamba di sostegno in rovere, rovere spessart, rovere tinto grigio, rovere cenere, olmo nero o massello di noce canaletto. l 1500 x 1500 - 1800 x 1800.
- 5 Snack Moon sp. 40. Ø 1500 con due gambe. Ø 1800 con tre gambe e piano centrale girevole integrato. Piano in rovere fossile, black ash o olmo nero, gambe e inserto finta gamba in massello di rovere fossile, black ash o tinto olmo nero. Piano centrale girevole in tutti i marmi e pietre previste in collezione.

- 6 Snack Sydney sp. 40. Da utilizzare sospeso o con gamba. Piano e gamba in massello di noce, black ash o tinto olmo nero. Sydney l 1550-1700-1850-2150 x 788 l 2450 x 895. Sydney con gamba l 1850 x 900 - 2150 x 1000.
- 7 Snack Blade sp. 40. Da utilizzare sospeso o con gambe. Piano e gambe in massello di noce canaletto, black ash o tinto olmo nero. La lunghezza dello snack rettangolare si può personalizzare al centimetro. Rettangolare da l 1400 a l 2700, p 900-950-1050-1150-1200-1280. Quadrato 1500 x 1500.

### Models and features

- 1 Snack th. 3 1/4" with two sides "folding" and frame. For suspended use or with legs. Slatted top in oak, spessart oak, dyed grey oak, cenere oak, black elm, Italian walnut or solid walnut canaletto. Legs and aluminium crossbars finish steel or embossed lacquer colours. w from 70 3/4" to 106 1/4" - pitch 11 3/4" d 35 1/2"-37 1/2"-41 1/4"-45 1/4"-47 1/4"-50 1/2".
- 2 Snack th. 3 1/4" four sides "folding". For suspended use or with legs. Slatted top in oak, spessart oak, dyed grey oak, cenere oak, black elm, Italian walnut or solid walnut canaletto. Cylindrical legs in steel. w from 70 3/4" to 106 1/4" - pitch 11 3/4" d 35 1/2"-37 1/2"-41 1/4"-45 1/4"-47 1/4"-50 1/2".
- 3 Snack th. 2". To be used on worktop th. 1/4"-1/2"-3/4" with aluminium supporting frame for the models Artex, Twelve, Phoenix and Trail. Top in oak, spessart oak, grey stained oak, cenere oak, elm, black elm or walnut c.; solid Italian walnut, black ash or stained black elm; laminate tuttocolore, laminate tuttocolore touch, embossed lacquer colours or in DuPont Corian®. On the edge of the laminate worktops, an inlay in contrast or matching colour is available. w up to 118" snack in lacquer or wood w up to 141 3/4" snack in DuPont Corian® w up to 161 1/2" snack in laminate Minimum overhang of the base units 13 3/4".
- 4 Square peninsula snack th. 3 1/4". To be used on worktop th. 1/4"-1/2" with supporting aluminium frame for the models Twelve, Phoenix and Trail and on worktops th. 3/4". Slatted top and supporting leg in oak, spessart oak, grey stained oak, cenere oak, black elm or solid walnut canaletto. w 59" x 59" - 70 3/4" x 70 3/4".
- 5 Snack Moon th. 1 1/2". Ø 59" with two legs. Ø 70 3/4" with three legs and swivel integrated central top. Top in fossil oak, black ash or black elm, legs and inlay as a leg in solid fossil oak, black ash or stained black elm. Swivel central top in all the marbles and stones in the collection.
- 6 Snack Sydney th. 1 1/2". For suspended use or with leg. Top and leg in solid walnut, black ash or stained black elm. Sydney w 61"-67"-72 3/4"-84 3/4" x 31" w 96 1/2" x 35 1/4". Sydney with leg w 72 3/4" x 35 1/2" - 84 3/4" x 39 1/4".
- 7 Snack Blade th. 1 1/2". For suspended use or with legs. Top and legs in solid walnut canaletto, black ash or stained black elm. The length of the rectangular snack can be customized to the centimeter. Rectangular from w 55" to 106 1/4", d 35 1/2"-37 1/2"-41 1/4"-45 1/4"-47 1/4"-50 1/2". Square 59" x 59".

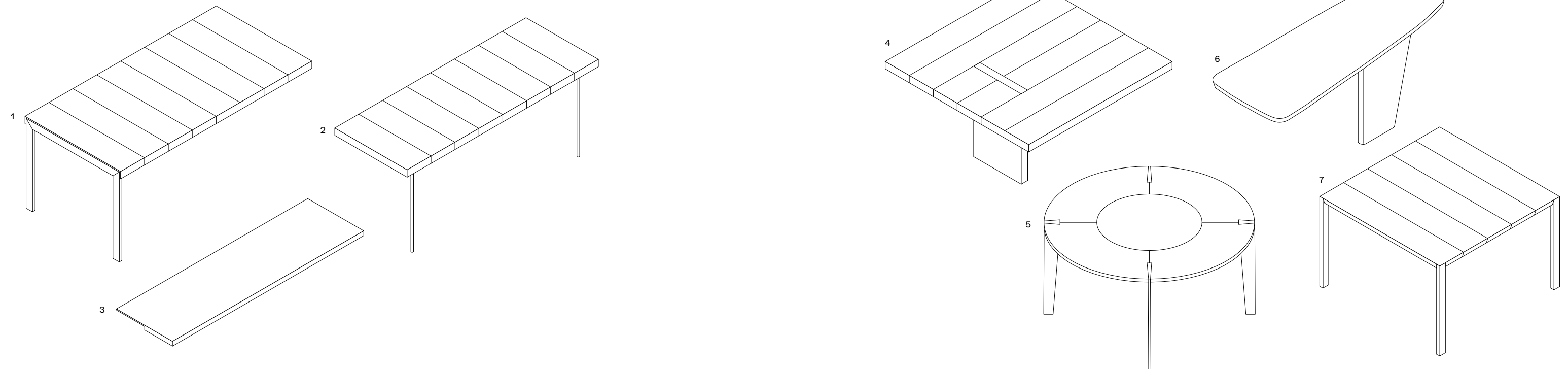

## TAVOLI TABLES



**Kensington**  
Design Jean-Marie Massaud, 2018

Struttura in alluminio spatolato ferro e bronzo o laccato opaco champagne. Piano in olmo nero, vetro fumé, marmo lucido noir saint laurent, marmo levigato e lucido bianco carrara, grigio stardust, calacatta oro o sahara noir finitura poliestere.

Il piano è caratterizzato dall'accostamento di moduli di forme e misure diverse.

Structure in aluminium with spatula finish ferro and bronzo or champagne mat lacquered. Top in black elm, fumé glass, glossy marble noir saint laurent, mat and glossy marble bianco carrara, grigio stardust,



**Henry**  
Design Emmanuel Gallina, 2019

Tavolo fisso o allungabile. Struttura in olmo nero o noce gold. Piano in olmo nero, noce gold, cinque marmi levigati e sei lucidi, vetro lucido nei colori ghiaccio, arena, grafite, bordeaux. Allungabile solo in essenza. Fixed or extendable table. Structure in black elm or walnut gold finish. Top in black elm, walnut gold, five mat marbles and six glossy marbles, glossy glass in the colours ghiaccio, arena, grafite, bordeaux. Extendable table only version in wood.

Dimensioni mm: rettangolare 2400 x 1080 - 2850 x 1080 h 740, quadrato 1700 x 1700 h 740 allungabile 1800/2400 x 1000 h 740  
Dimensions in: rectangular 94 1/2" x 42 1/2" - 112 1/4" x 42 1/2" h 29 1/4", square 67" x 67" h 29 1/4" extendable 70 3/4"/94 1/2" x 39 1/4" h 29 1/4"



**Concorde**  
Design Emmanuel Gallina, 2009

Struttura in massello, finitura in noce gold, noce c., rovere spessart, rovere cenere o olmo nero. Piano in noce gold, noce c., rovere spessart, rovere cenere, olmo nero, cinque marmi levigati e sei lucidi. Per le versioni rettangolari è disponibile anche il piano in vetro lucido colori o in vetro riflettente blu con cornice in essenza. Per i tavoli Ø 1800 e 2000 mm è previsto un piano girevole opzionale in appoggio in laccato opaco colori, laccato lucido colori, noce gold, noce c., rovere spessart, rovere cenere, olmo nero, cinque marmi levigati e sei lucidi.

Structure in solid wood finish in walnut gold, walnut c., spessart oak, cenere oak or black elm. Top in walnut gold, walnut c., spessart oak, cenere oak, black elm, five mat and six glossy marble finishes. For the rectangular versions, the tabletop is available also in glossy glass or in blue reflecting glass with wooden frame. For the tables Ø 70 3/4" and 78 3/4" mm an optional swivel tray lean on the tabletop in the following finishes is available: mat lacquered colours, glossy lacquered colours, walnut gold, walnut c., spessart oak, cenere oak, black elm, five mat and six glossy marble finishes.

Dimensioni mm: rettangolare 2185 x 1080 - 2400 x 1080 - 2800 x 1080 h 740  
rotondo Ø 1370 - Ø 1800 - Ø 2000 h 740  
Ø 1800 piano girevole opzionale Ø 900  
Ø 2000 piano girevole opzionale Ø 1050  
Dimensions in: rectangular 86" x 42 1/2" - 94 1/2" x 42 1/2" - 110 1/4" x 42 1/2" h 29 1/4" round Ø 54" - Ø 70 3/4" - Ø 78 3/4" h 740  
Ø 70 3/4" optional spinning tray Ø 35 1/2" Ø 78 3/4" optional spinning tray Ø 41 1/4"



**Mondrian**  
Design Jean-Marie Massaud, 2019

Struttura in fusione di alluminio, finitura brown nickel opaco o champagne opaco.

Piano in olmo nero, noce gold, vetro fumé, cinque marmi levigati e sei lucidi.

Structure in aluminium casting, finish mat brown nickel or mat champagne.

Top in black elm, walnut gold, fumé glass, five mat marbles and six glossy marbles.

Dimensioni mm: ellittico 2400 x 1220 - 2800 x 1300 h 740  
rotondo Ø 1400 - Ø 1600 h 740  
Dimensions in: ellittico 94 1/2" x 48" - 110 1/4" x 51 1/4" h 29 1/4" round Ø 55" - Ø 63" h 29 1/4"



**Blade**  
Design R&D Poliform, 2014

Struttura e piano in massello di noce canaletto, massello black ash o massello tinto olmo nero. Nella versione rettangolare la lunghezza del tavolo si può personalizzare al centimetro.

Structure and top in solid canaletto walnut, solid black ash or solid wood stained black elm. The length of the rectangular table can be customized.  
Dimensioni mm: quadrato 1100 x 1100 - 1400 x 1400 rettangolare da 1400 a 3000 x 1100 h 740  
Dimensions in: square 43 1/4" x 43 1/4" - 55" x 55" rectangular from 55" to 118" x 43 1/4" h 29 1/4"



**Home Hotel**  
Design Jean-Marie Massaud, 2016

Struttura in massello finitura olmo nero o massello noce gold. Piano in olmo nero, cinque marmi levigati e sei lucidi. Versione in noce gold disponibile solo con piano in marmo.

I tavoli Ø 1800 e 2000 mm hanno un piano girevole integrato in olmo nero, noce gold, cinque marmi levigati e sei lucidi. Per i tavoli Ø 1800 e 2000 con piani in marmo, il piano girevole è disponibile solo in olmo nero o noce gold.

Structure in solid wood finish black elm or solid walnut gold. Top in black elm, five mat marbles and six glossy

marbles. Version in walnut gold available only with top in marble. The tables Ø 70 3/4" and 78 3/4" have an integrated swivel top in black elm, walnut gold, five mat and six glossy marble finishes. For tables Ø 70 3/4" and 78 3/4" with marble top the swivel top is available only in black elm or walnut gold.

Dimensioni mm: rettangolare 2400 x 1100 3000 x 1100 h 740  
rotondo Ø 1600 - Ø 1800 - Ø 2000 h 740  
Ø 1800 piano girevole integrato Ø 900  
Ø 2000 piano girevole integrato Ø 1100

Dimensioni in: rettangolare 94 1/2" x 43 1/4" - 118" x 43 1/4" h 29 1/4" round Ø 63" - Ø 70 3/4" - Ø 78 3/4" h 29 1/4" Ø 70 3/4" integrated spinning tray Ø 35 1/2" Ø 78 3/4" integrated spinning tray Ø 43 1/4"



**Opéra**  
Design Emmanuel Gallina, 2014

Tavolo fisso o allungabile. Struttura in noce c. o rovere spessart. Piano in noce c., rovere spessart, cinque marmi levigati e sei lucidi. Nel tavolo allungabile con piano in marmo finitura prolunghe come la struttura. Fixed or extendable table. Structure in walnut c. or spessart oak. Top in walnut c., spessart oak, five mat and six glossy marble finishes. The extensions of the extendable table with marble top are in the same finish of the structure.

Dimensioni mm: fisso 2880 x 1100 h 740 allungabile 2080/2980 x 969 h 740  
Dimensions in: fixed 113 1/2" x 43 1/4" h 29 1/4" extensible 82"/117 1/4" x 38 1/4" h 29 1/4"



**Flute**  
Design Roberto Barbieri, 2008

Struttura laccato opaco colori, laccato lucido colori, laccato antigraffio o verniciato brown nickel opaco e lucido. Piano laccato opaco colori, laccato lucido colori, laccato antigraffio nei colori bianco 01, carbone 91, grafite 04, canapa 35, cinque marmi levigati e sei lucidi. Structure in mat lacquered colours, glossy lacquered colours, anti-scratch lacquered colours or brown nickel mat and glossy finishes. Top in mat lacquered colours, glossy lacquered colours, anti-scratch lacquer in the colours bianco 01, carbone 91, grafite 04, canapa 35, five mat and six glossy marble finishes.

Dimensioni mm: piano laccato Ø 900 - Ø 1250 - Ø 1400 - piano marmo Ø 900 - Ø 1230 - Ø 1370 h 740  
Dimensions in: lacquered top Ø 35 1/2" - Ø 49 1/4" - Ø 55" - marble top Ø 35 1/2" - Ø 48 1/2" - Ø 54" h 29 1/4"



**Howard**  
Design Jean-Marie Massaud, 2011

Struttura in massello, finitura in rovere spessart o olmo nero. Telaio in metallo tagliato a laser e piegato, verniciato brown nickel opaco. Piano in rovere spessart, cinque marmi levigati e sei lucidi.

Structure in solid wood, finishes spessart oak or black elm. Frame in laser cut and folded metal painted mat brown nickel. Top in spessart oak, five mat and six glossy marble finishes.

Dimensioni mm: 2200 x 1000 - 2800 x 1100 h 740  
Dimensions in: 86 1/2" x 39 1/4" - 110 1/4" x 43 1/4" h 29 1/4"



**Mad Dining Table**  
Design Marcel Wanders, 2015

Struttura in massello, finitura in rovere spessart o olmo nero. Piano in rovere spessart, olmo nero, cinque marmi levigati e sei lucidi.

Structure in solid wood, spessart oak or black elm finish. Top in spessart oak, black elm, five mat and six glossy marble finishes.  
Dimensioni mm: 2200 x 1100 - 2790 x 1100 h 740  
Dimensions in: 86 1/2" x 43 1/4" - 109 3/4" x 43 1/4" h 29 1/4"



**Gill**  
Design Roberto Barbieri, 2010

Tavolo allungabile. Struttura in massello, finitura in rovere spessart. Piano in rovere spessart. Extendable table. Structure in solid wood spessart oak finish. Top in spessart oak.

Dimensioni mm: 1550/2100 x 900 h 740 1800/2350 x 900 h 740 2000/2620 x 1000 h 740  
Dimensions in: 61"/82 3/4" x 35 1/2" h 29 1/4" 70 3/4"/92 1/2" x 35 1/2" h 29 1/4" 78 3/4"/103 1/4" x 39 1/4" h 29 1/4"



**Trevi**  
Design Roberto Barbieri, 2005

Struttura in trafilato alluminio laccato opaco colori, laccato antigraffio o verniciato brown nickel opaco e lucido. Piano laccato opaco colori o laccato antigraffio nei colori bianco 01, carbone 91, grafite 04 e canapa 35. Structure in extruded aluminium in the finishes mat lacquered colours, anti-scratch lacquer or brown nickel mat and glossy. Top in mat lacquered colours, or anti-scratch lacquer in the colours bianco 01, carbone 91, grafite 04, canapa 35.

Dimensioni mm: quadrato 900 x 900 - 1250 x 1250 rettangolare 1400 x 800 - 1800 x 900 h 740  
Dimensions in: square 35 1/2" x 35 1/2" - 49 1/4" x 49 1/4" rectangular 55" x 31 1/2" - 70 3/4" x 35 1/2" h 29 1/4"

## SEDIE CHAIRS



**Stanford Bridge**  
Design Jean-Marie Massaud, 2018

Scocca imbottita e rivestimento non sfoderabile in tessuto o pelle. Basamento girevole con ritorno, in brown nickel opaco e lucido o champagne opaco. Body upholstered and covered in non-removable fabric or leather. Base with automatic returning mechanism, in mat and glossy brown nickel or mat champagne. Dimensioni mm: sedia | 570 p 560 h 800 sedia con braccioli | 620 p 560 h 800 Dimensions in: chair w 22 1/2" d 22" h 31 1/2" chair with arms w 24 1/2" d 22" h 31 1/2"



**Sophie**  
Design Emmanuel Gallina, 2017

Seduta imbottita e rivestimento non sfoderabile in tessuto o pelle. Struttura in noce gold, rovere spessart o olmo nero. Seat upholstered and covered in non-removable fabric or leather. Structure in walnut gold, spessart oak or black elm. Dimensioni mm: sedia | 570 p 600 h 780 sedia con braccioli | 630 p 600 h 780 dimensions in: chair w 22 1/2" d 23 1/2" h 30 3/4" chair with arms w 24 3/4" d 23 1/2" h 30 3/4"



**Grace**  
Design Emmanuel Gallina, 2009

Seduta imbottita e rivestimento non sfoderabile in tessuto, pelle o pelle Nabuk intrecciata (solo per retro schienale). Struttura in noce gold, noce c., rovere cenere, rovere spessart o olmo nero. Seat upholstered and covered in non-removable fabric, leather or woven leather Nabuk (available only for the rear of the backrest). Structure in walnut gold, walnut c., cenere oak, spessart oak or black elm. Dimensioni mm: con/senza braccioli | 535 p 540 h 815 Dimensions in: with/without arms w 21" d 21 1/4" h 32"



**Seattle**  
Design Jean-Marie Massaud, 2015

Seduta e schienale completamente rivestiti in cuoio non sfoderabile nei colori 19 caffè, 02 nero, 26 invecchiato o 29 tortora con punzonatura estetica (brogueing) perimetrale. Gambe in rovere spessart, rovere naturale e olmo nero o completamente rivestite in cuoio nei colori 19 caffè, 02 nero, 26 invecchiato o 29 tortora. Seat and backrest fully covered in non-removable hide in the colours 19 caffè, 02 nero, 26 invecchiato or 29 tortora with perimeter decorative punching

(brogueing). Legs in spessart oak, natural oak and black elm or fully covered in hide in the colours 19 caffè, 02 nero, 26 invecchiato or 29 tortora. Dimensioni mm: sedia | 530 p 550 h 790 sedia con braccioli | 560 p 550 h 790 Dimensions in: chair w 20 3/4" d 21 3/4" h 31" chair with arms w 22" d 21 3/4" h 31"



**Ipanema**  
Design Jean-Marie Massaud, 2015

Seduta imbottita e rivestimento non sfoderabile in tessuto o pelle. Struttura in rovere spessart o olmo nero. Seat upholstered and covered in non-removable fabric or leather. Structure in spessart oak or black elm. Dimensioni mm: sedia | 540 p 545 h 815 sedia con braccioli | 575 p 545 h 815 Dimensions in: chair w 21 1/4" d 21 1/2" h 32" chair with arms w 22 3/4" d 21 1/2" h 32"



**Ventura**  
Design Jean-Marie Massaud, 2011

Scocca imbottita e rivestimento non sfoderabile in tessuto o pelle. Cucitura normale doppia o solo per la versione in tessuto (escluso velluto) cucitura a cordoncino in tinta. Struttura in rovere cenere, rovere spessart o olmo nero. Body upholstered and covered in non-removable fabric or leather. Double normal stitching or drawstring stitching in matching colour, only for the version in fabric (except velvet). Structure in cenere oak, spessart oak or black elm.



Dimensioni mm: sedia | 505 p 540 h 815 sedia con braccioli | 555 p 540 h 815 Dimensions in: chair w 20" d 21 1/4" h 32" chair with arms w 21 3/4" d 21 1/4" h 32"



**Ventura**  
Design Jean-Marie Massaud, 2011

Scocca imbottita e rivestimento non sfoderabile in tessuto o pelle. Struttura in metallo verniciato brown nickel opaco o laccato opaco colori. Body upholstered and covered in non-removable fabric or leather. Structure in mat or glossy brown nickel painted metal. Dimensioni mm: sedia | 505 p 540 h 815 sedia con braccioli | 555 p 540 h 815 Dimensions in: chair w 20" d 21 1/4" h 32" chair with arms w 21 3/4" d 21 1/4" h 32"



**Mad Dining Chair**  
Design Marcel Wanders, 2015

Scocca imbottita e rivestimento non sfoderabile in tessuto o pelle. Possibilità di rivestimento diverso tra interno ed esterno della scocca. Il rivestimento Gibson matelassé è disponibile solo per la scocca interna. Gambe in rovere spessart o olmo nero. Body upholstered and covered in non-removable fabric or leather. The inner and outer cover can be in two different materials. Fabric Gibson matelassé is available only for the inner cover. Legs in solid wood in the finishes spessart oak or black elm.

Dimensioni mm: sedia | 480 p 575 h 790 sedia con braccioli | 630 p 575 h 790 dimensions in: chair w 19" d 22 3/4" h 31" chair with arms w 24 3/4" d 22 3/4" h 31"



**Harmony**  
Design Rodrigo Torres, 2012

Scocca in legno curvato con tecnica 3d finitura rovere spessart. Struttura in massello, finitura rovere spessart o in tondino di metallo finitura in cromo nero. Body in curved wood with 3D technology, finish spessart oak. Structure in solid wood spessart oak finish or in metal rod in black chrome finish. Dimensioni mm: | 460 p 480 h 795 Dimensions in: w 18" d 19" h 31 1/4"



**Guest**  
Design Rodolfo Dordoni, 2014

Scocca imbottita e rivestimento non sfoderabile in tessuto o pelle. Cuscino seduta con rivestimento sfoderabile in tessuto o pelle. Ruote a scomparsa. Body upholstered and covered in non-removable fabric or leather. Seat cushion with removable cover in fabric or leather. Invisible wheels. Dimensioni mm: | 575 p 610 h 835 Dimensions in: w 22 3/4" d 24" h 32 3/4"



**Velvet**  
Design R&D Poliform, 2007

Seduta imbottita e rivestimento sfoderabile in tessuto o pelle. Gambe in laccato opaco colori, noce c. o rovere spessart. Seat upholstered and covered in removable fabric or leather. Legs in mat lacquered colour, walnut c. or spessart oak. Dimensioni mm: sedia | 525 p 560 h 770 sedia con braccioli | 580 p 590 h 770 Dimensions in: chair w 20 3/4" d 22" h 30 1/4" chair with arms w 22 3/4" d 23 1/4" h 30 1/4"



**Velvet Due**  
Design R&D Poliform, 2007

Seduta imbottita e rivestimento sfoderabile in tessuto. Gambe in laccato opaco colori, noce c. o rovere spessart. Seat upholstered and covered in removable fabric. Legs in mat lacquered colour, walnut c. or spessart oak. Dimensioni mm: sedia | 575 p 590 h 770 sedia con braccioli | 580 p 590 h 770 Dimensions in: chair w 22 3/4" d 23 1/4" h 30 1/4" chair with arms w 22 3/4" d 23 1/4" h 30 1/4"



**Manta**  
Design Rodrigo Torres, 2007

Seduta e gambe completamente rivestite in pelle non sfoderabile. Seat and legs fully covered in non-removable leather. Dimensioni mm: sedia | 520 p 530 h 770 sedia con braccioli | 570 p 550 h 770 Dimensions in: chair w 20 1/2" d 20 3/4" h 30 1/4" chair with arms w 22 1/2" d 21 3/4" h 30 1/4"



**BB**  
Design Blumer e Borghi, 2008

Struttura completamente rivestita e non sfoderabile in cuoio co-stampato nei colori 02 nero, 03 grigio scuro, 19 caffè o 26 invecchiato. Structure fully covered in non-removable hide in the colours 02 nero, 03 grigio scuro, 19 caffè or 26 invecchiato. Dimensioni mm: | 465 p 535 h 780 Dimensions in: w 18 1/4" d 21" h 31 1/4"

## SGABELLI STOOLS



**Sophie**  
Design Emmanuel Gallina, 2018

Seduta e schienale con parti in poliuretano flessibile a quote differenziate e parti in poliuretano flessibile stampato, prerivestimento in fibra di poliestere. Rivestimento non sfoderabile in tessuto o pelle. Struttura in massello, finitura noce gold, rovere spessart o olmo nero. Poggiatestai in metallo verniciato brown nickel opaco con inserto inox satinato. Seat and back with parts in flexible polyurethane in different densities and parts in moulded flexible

polyurethane, pre-cover in polyester fibre. Non-removable cover in fabric or leather. Structure in solid wood, finish walnut gold, spessart oak or black elm. Footrest in mat brown nickel painted metal with inlay in brushed stainless steel. Dimensioni mm: l 550 p 550 h 660/870 alto l 550 p 550 h 760/970 Dimensions in: w 21 3/4" d 21 3/4" h 26" 34 1/4" high w 21 3/4" d 21 3/4" h 30" 38 1/4"



**Ventura**  
Design Jean-Marie Massaud, 2016

Scocca in poliuretano flessibile stampato, prerivestimento in fibra di poliestere. Rivestimento non sfoderabile in tessuto o pelle. Cucitura normale doppia o solo per la versione in tessuto (escluso velluto) cucitura a cordoncino in tinta. Struttura in massello, finitura rovere spessart o olmo nero. Poggiatestai in acciaio inox. Body in moulded flexible polyurethane, pre-cover in polyester fibre. Non-removable cover in fabric or leather. Normal double stitching or drawstring

stitching in matching colour only for the fabric version (except velvet). Structure in solid wood, spessart oak or black elm finish. Footrest in stainless steel. Dimensioni mm: l 485 p 470 h 650/850 alto l 485 p 500 h 750/950 Dimensions in: w 19" d 18 1/2" h 25 1/2"/33 1/2" high w 19" d 19 3/4" h 29 1/2"/37 1/2"



**Harmony**  
Design Rodrigo Torres, 2012

Scocca in legno curvato con tecnica 3D, finitura rovere spessart. Struttura in tondino di metallo finitura cromo nero. Body in curved wood with 3D technology, spessart oak finish. Structure in metal rod black chrome finish. Dimensioni mm: l 445 p 450 h 660/815 Dimensions in: w 17 1/2" d 17 3/4" h 26" 32"



**Ics**  
Design Rodrigo Torres, 2010

Seduta in rovere spessart. Struttura in massello, finitura rovere spessart con poggiatestai in acciaio inox. Seat in spessart oak. Structure in solid wood, spessart oak finish with footrest in stainless steel. Dimensioni mm: l 440 p 340 h 660 Dimensions in: w 17 1/2" d 13 1/2" h 26"

## PANCHE BENCHES



**Home Hotel**  
Design Jean-Marie Massaud, 2016

Seduta in olmo nero rivestita in cordatura di pelle testa di moro. Struttura in massello, finitura olmo nero. Cuscino opzionale con rivestimento sfoderabile in tessuto o pelle; nella versione pelle Nabuk possibilità pelle Nabuk intrecciata nella parte superiore. Seat in black elm, covered with dark brown stringed leather. Structure in solid wood, black elm finish. Optional cushion with removable cover in fabric or leather; in the version in leather Nabuk, the upper part can be in woven leather. Dimensioni mm: l 1000 p 490 h 440 l 1440 p 490 h 440 Dimensions in: w 20" d 21 1/4" h 32" w 21 3/4" d 21 1/4" h 32"



**Jane**  
Design Emmanuel Gallina, 2017

Seduta in poliuretano flessibile a quote differenziate, prerivestimento in fibra di poliestere. Rivestimento in tessuto sfoderabile o in pelle non sfoderabile. Struttura in massello, finitura noce gold, rovere spessart o olmo nero. Struttura in metallo verniciato brown nickel opaco o lucido. Seat in flexible polyurethane in different densities, pre-cover in polyester fibre. Cover in removable fabric or in non-removable leather. Structure in solid wood, walnut gold, spessart oak or black elm finish. Structure in mat or glossy brown nickel painted metal. Dimensioni mm: l 1300 p 500 h 480 Dimensions in: w 51 1/4" d 19 3/4" h 19"



FINITURE  
FINISHINGS

**Laccato gofrato e lucido**  
**Embossed and glossy lacquered**

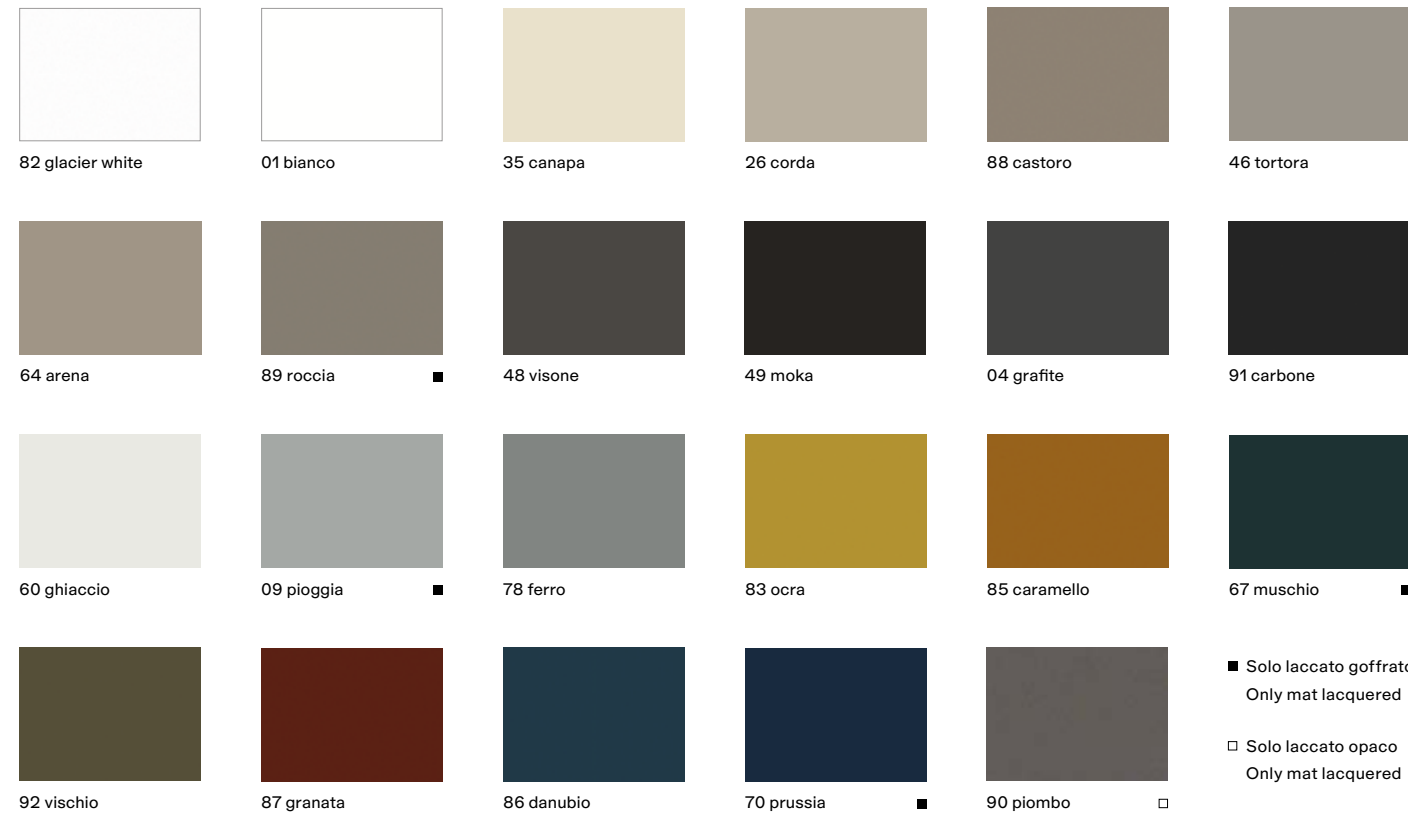

■ Solo laccato gofrato  
Only mat lacquered

□ Solo laccato opaco  
Only mat lacquered

**Laccato metallico**  
**Metallic lacquered**



**Vetro riflettente**  
**Reflecting glass**

**Vetro satinato**  
**Frosted glass**

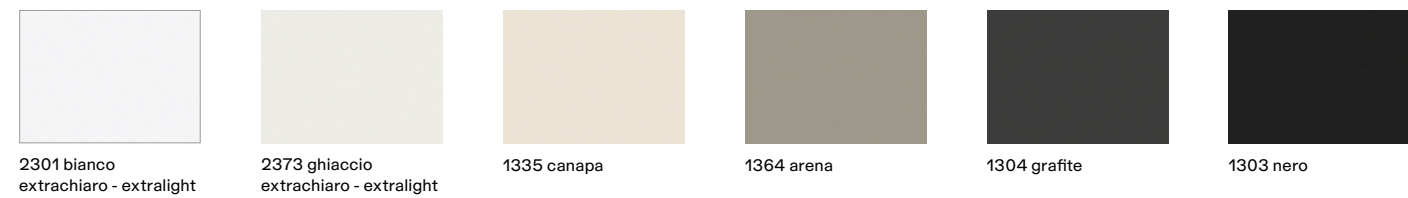

**Vetro lucido**  
**Glossy glass**



**Essenze**  
**Woods**

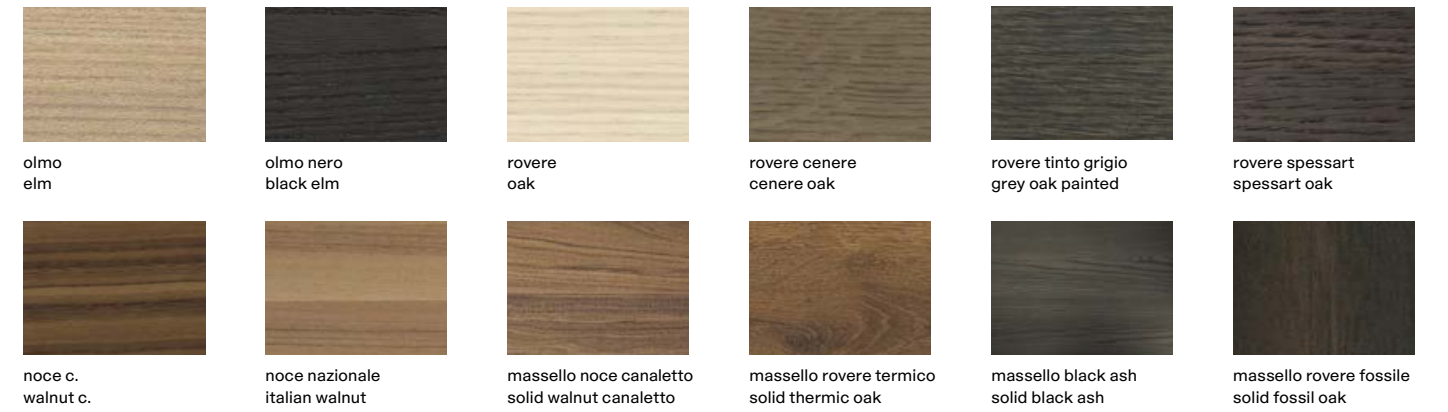

**Nobilitato**  
**Melamine**



**Nobilitato silk**  
**Silk melamine**



**Laminato opaco**  
**Mat laminate**

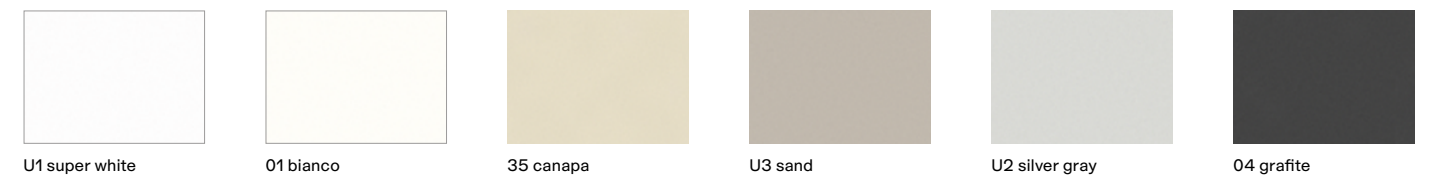

**Laminato opaco touch**  
**Mat laminate touch**

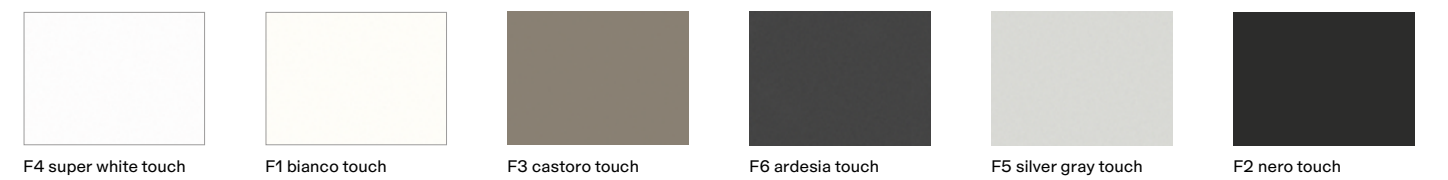

FINITURE  
FINISHINGS

**Quarzite lucida**  
Glossy composite stone



21 super white    01 white sand    25 white va    23 silver gray    26 beige va    22 portland grey

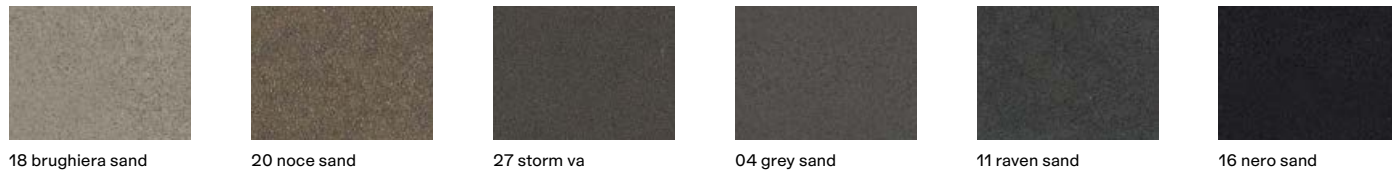

18 brughiera sand    20 noce sand    27 storm va    04 grey sand    11 raven sand    16 nero sand

**Quarzite micropallinata**  
Micro-blasted composite stone



21 super white    01 white sand    25 white va    23 silver gray    26 beige va    22 portland grey

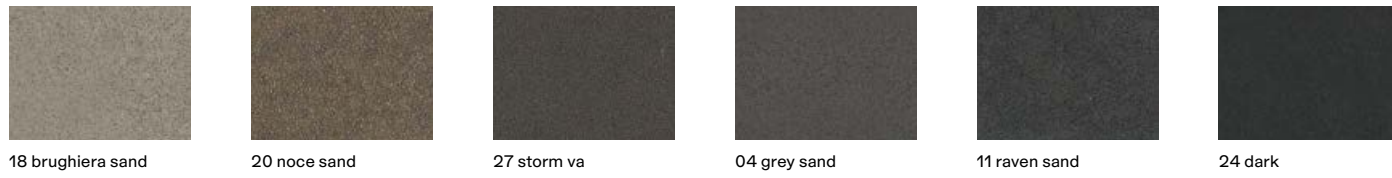

18 brughiera sand    20 noce sand    27 storm va    04 grey sand    11 raven sand    24 dark



16 nero sand

**Marmo levigato**  
Mat marble



bianco carrara    calacatta oro    emperador extra dark



noir saint laurent    calacatta oro    emperador extra dark

**Pietra**  
Stone



fossena fiammata / blaze    stone brown levigata / mat    stone grey levigata / mat

**Inalco MDi®**  
Inalco MDi®

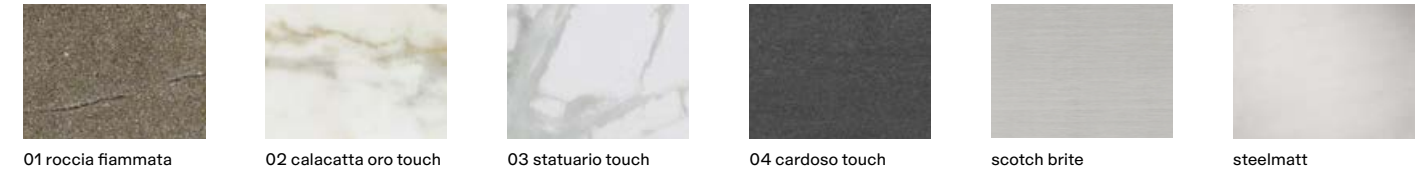

01 roccia fiammata    02 calacatta oro touch    03 statuario touch    04 cardoso touch    scotch brite    steelmatt

**Dekton**  
Dekton



05 bianco    03 grigio cemento    04 grigio Londra    02 tortora    01 nero

**DuPont Corian®**  
DuPont Corian®

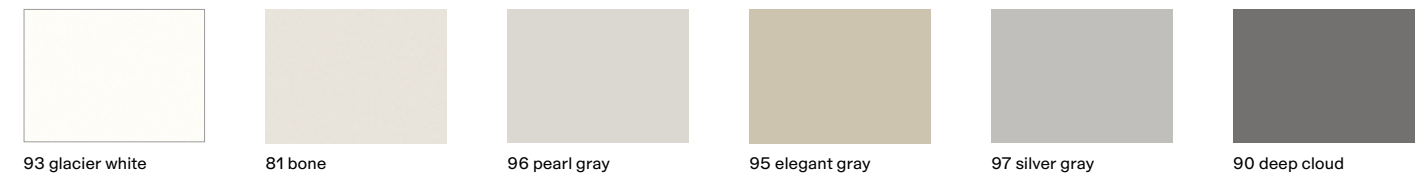

93 glacier white    81 bone    96 pearl gray    95 elegant gray    97 silver gray    90 deep cloud

**Laminato tuttocolore**  
Tuttocolore laminato

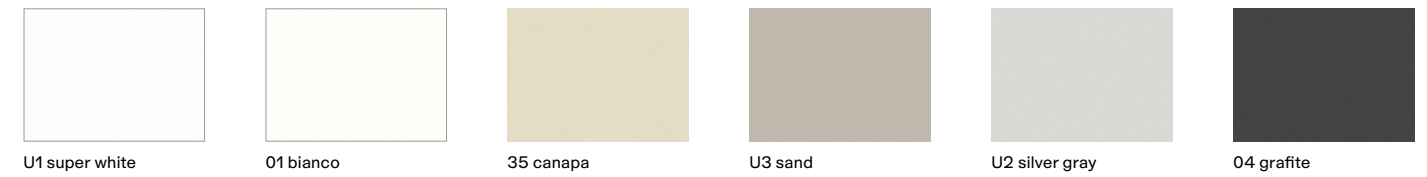

U1 super white    01 bianco    35 canapa    U3 sand    U2 silver gray    04 grafite

**Laminato tuttocolore touch**  
Tuttocolore laminate touch

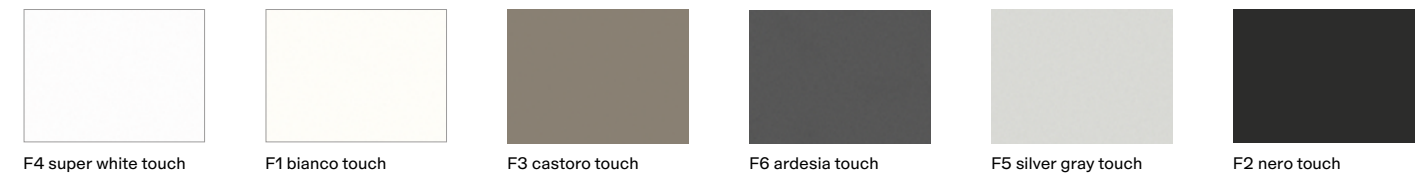

F4 super white touch    F1 bianco touch    F3 castoro touch    F6 ardesia touch    F5 silver gray touch    F2 nero touch



F7 acciaio touch    F8 alluminio touch    F9 champagne touch

**Acciaio**  
Steel



scotch brite    steelmatt

**Poliform Spa**

via Montesanto 28  
Casella postale n. 1  
22044 Inverigo (CO) Italy  
t +39 031 6951  
f +39 031 699444  
info@poliform.it  
poliform.it

**Poliform realizza tutte le sue collezioni in Italia usando componenti e materie prime selezionate.**

**All the Poliform collections are manufactured 100% in Italy using top-class components and materials.**

Poliform si riserva il diritto di apportare, senza preavviso, ogni modifica mirata al miglioramento funzionale e qualitativo dei propri prodotti. Testi e disegni presenti in questo stampato hanno scopo divulgativo; per ogni aspetto tecnico e dimensionale fare riferimento ai listini aziendali e relativi aggiornamenti. I campioni di colori e materiali hanno valore indicativo.

Poliform reserves the rights at all time to apply modifications for the functional or qualitative improvement of its products. Texts and drawings present in this brochure have a divulgative purpose; for every technical and dimensional aspect please refer to the company's price lists and their relative updatings. The colour and material samples have an indicative value.



2018 Adi Compasso D'oro  
Career Award