

Poliform

SENZAFINE

WALK-IN CLOSETS

Poliform

SENZAFINE WALK-IN CLOSET
DIGITAL CATALOGUE

La cabina armadio Senzafine reinterpreta il sistema armadio in modo leggero ed elegante senza rinunciare alla solidità, assicurata dai fianchi più spessi. Senza ante, i volumi di contenimento sono aperti e offrono la massima libertà di configurazione. Le finiture sono protagoniste, così come l'attrezzatura interna, da scegliere in base alle necessità combinando tubi appendiabiti, cassettiere, ripiani e vassoi estraibili.

The Senzafine walk-in closet reinterprets the wardrobe system with a light and elegant approach without sacrificing solidity, ensured by the thicker sides. Without doors, the storage volumes are open and offer maximum configuration freedom. The finishes are the protagonists, as is the internal equipment, to be chosen according to need by combining closet rods, chests of drawers, shelves, and pull-out trays.



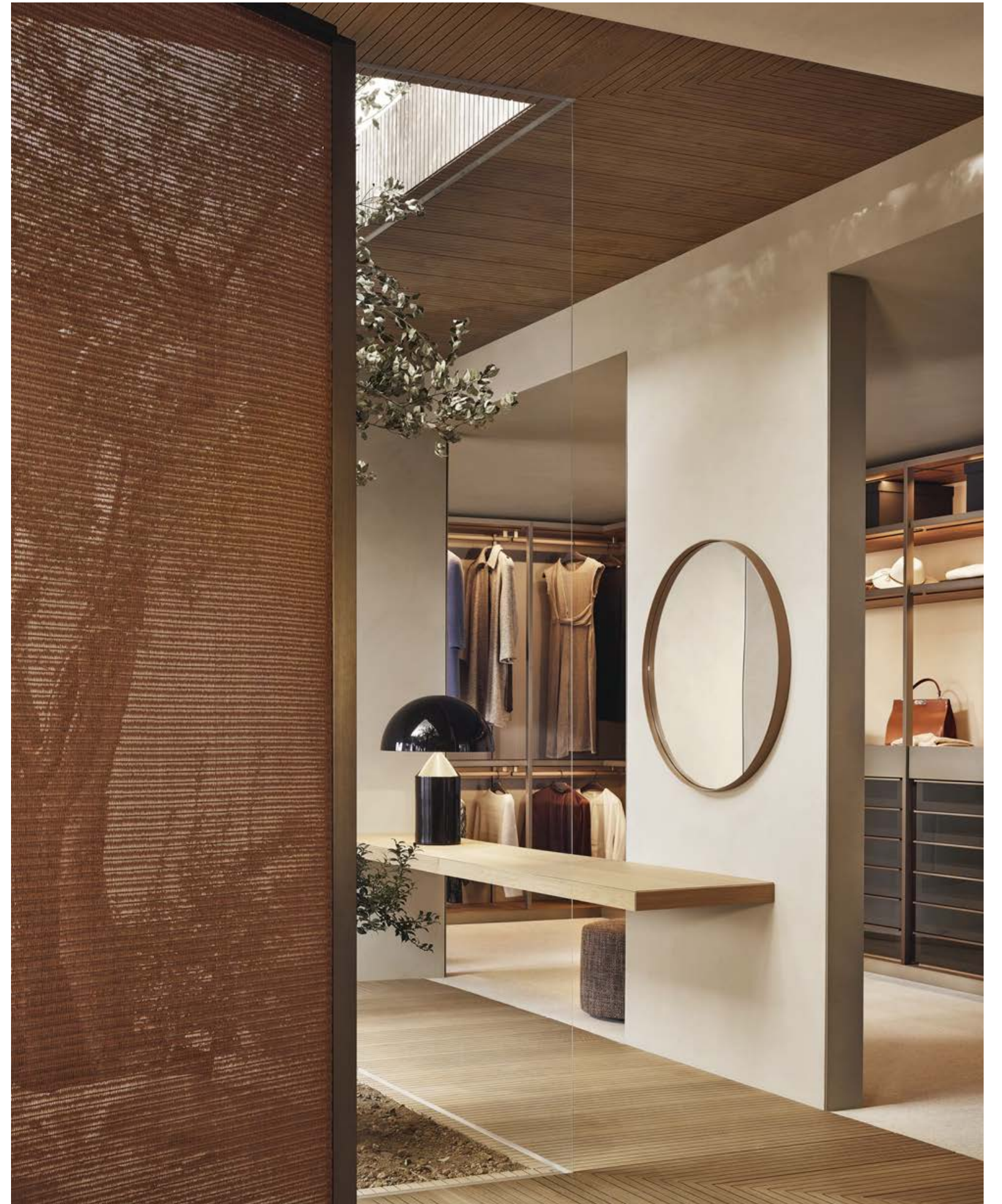



Qui, nelle pagine precedenti e successive: cabina armadio Senzafine con struttura in nobilitato olmo, fianchi a telaio, bordi e fascia zoccolo in champagne opaco, schienali in metacrilato roller latte. Ripiani superiori in nobilitato olmo e frontale champagne opaco, luce led integrata. Tubi appendiabiti rivestiti in tecnopelle 06 nocciola e champagne opaco. Ripiani inferiori in tecnopelle 06 nocciola con telaio champagne opaco. Cassettiere a vetrina con piano superiore in vetro fumé, cassetto con frontale a smusso in laccato opaco champagne e piano in tecnopelle 06 nocciola. Cassetti inferiori in nobilitato olmo e in vetro riflettente fumé con maniglia Track champagne opaco. Pouf New York in tessuto sfoderabile Antea 05 terra di siena. Specchio Circle con cornice in cuoio 26 invecchiato e specchio bianco. Poltrona Santa Monica in velluto sfoderabile Tebe 11 bruciato.

Here, previous and next pages: Senzafine walk-in closet with structure in elm melamine, frame sides, edges and plinth filler in mat champagne, backs in methacrylate roller latte. Upper shelves in elm melamine and front in mat champagne, integrated led light. Hanging rails covered in techno leather 06 nocciola and mat champagne. Lower shelves in techno leather 06 nocciola with mat champagne frame. Display case chests of drawers with top in glass fumé, drawer with front with chamfered edge mat lacquered champagne and shelf in techno leather 06 nocciola. Lower drawers in elm melamine and in fumé reflecting glass with mat champagne Track handle. New York pouf in removable fabric Antea 05 terra di siena. Circle mirror with frame in hide 26 invecchiato and white mirror. Santa Monica armchair in removable velvet Tebe 11 bruciato.







A sinistra: cabina armadio Senzafine con struttura in nobilitato olmo, fianchi a telaio in champagne opaco, schienali in metacrilato roller latte. Ripiani superiori in nobilitato olmo e frontale champagne opaco, luce led integrata. Tubi appendiabiti rivestiti in tecnopelle 06 nocciola e champagne opaco. Cassettiere a vetrina in laccato opaco champagne e cassetti inferiori in vetro riflettente fumé con maniglia Track champagne opaco. Poltrona Santa in velluto sfoderabile Tebe 11 bruciato. Tavolino Nara in legno massello noce gold. Armadio Senzafine Cover con ante battenti in tecnopelle 05 latte e profili champagne opaco. Sotto: dettaglio della cassettiere a vetrina con piano superiore in vetro fumé, piano in tecnopelle 06 nocciola e luce led integrata, ripiano in tecnopelle 06 nocciola con telaio champagne opaco.

To the left: Senzafine walk-in closet with structure in elm melamine, frame sides in mat champagne, backs in methacrylate roller latte. Upper shelves in elm melamine and mat champagne front, integrated led light. Hanging rails covered in techno leather 06 nocciola and mat champagne. Display case chests of drawers in mat lacquered champagne and lower drawers in fumé reflecting glass with mat champagne Track handle. Santa Monica armchair in removable velvet Tebe 11 bruciato. Nara coffee table in solid wood gold walnut. Wardrobe Senzafine Cover with leaf doors in techno leather 05 latte and mat champagne profiles. Below: close up of the display case chest of drawers with top in fumé glass, shelf in techno leather 06 nocciola and integrated led light, next to it, shelf in techno leather 06 nocciola with mat champagne frame.



INTERIOR 13

Senzafine cabina armadio

h 2590 p 584

Struttura: nobilitato olmo.

Schienali: metacrilato roller latte.

Fianco telaio: champagne opaco.

Attrezzatura: nobilitato olmo, vetro fumé

3050, vetro riflettente fumé 5059,

tecnopelle 06 nocciola.

Parti metalliche: champagne opaco.

Senzafine walk-in closet

h 102" d 23"

Structure: elm melamine.

Backs: methacrylate roller latte.

Frame side: mat champagne.

Equipment: elm melamine, fumé glass

3050, fumé reflecting glass 5059,

techno leather 06 nocciola.

Metal parts: mat champagne.

Senzafine

Design R&D Poliform

Cassettiera a vetrina - Showcase chest of drawers

Design Rodolfo Dordoni

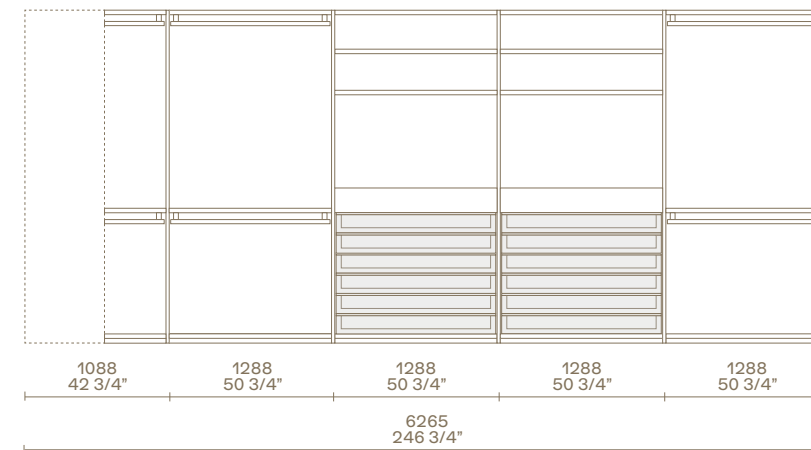
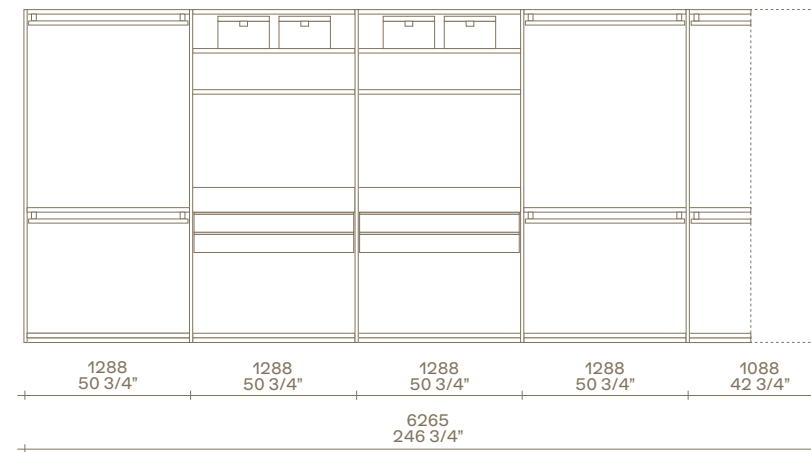







Nelle pagine precedenti e nella successiva: cabina armadio Senzafine con struttura in nobilitato ardesia e schienali in metacrilato roller latte, fianchi a telaio in ardesia opaco e luce led integrata. Ripiani superiori in nobilitato ardesia e tecnopelle 05 latte con telaio ardesia opaco, scatole con coperchio rivestite in tessuto ardesia. Al centro, ante battenti Fitted in vetro trasparente riflettente con telaio e maniglie in ardesia opaco. Cassettiera a isola Set-up con struttura in laccato opaco ardesia e piano superiore in vetro fumé e tecnopelle 05 latte, cassetti con frontali in vetro riflettente fumé, maniglia Track ardesia opaco. Vano a giorno con ripiano in vetro fumé, ripiano e fondo cassetti in tecnopelle 05 latte. Pouf Henry in olmo nero e seduta in pelle non sfoderabile Nabuk 09 ruggine. Tappeto Tratto ruggine. Poltrona Jane Large in tessuto sfoderabile Sendai 03 fango e basamento in olmo nero. A sinistra: dettaglio delle cassettiere a vetrina con piano superiore in vetro fumé, cassetto con frontale a smusso in laccato opaco ardesia e piano in tecnopelle 05 latte. Cassetti inferiori con frontali in vetro riflettente fumé con bordo e maniglia Track in ardesia opaco, piani in tecnopelle 05 latte.

Previous and next pages: Senzafine walk-in closet with structure in ardesia melamine and backs in methacrylate roller latte, frame sides in mat ardesia and integrated led light. Upper shelves in melamine ardesia and techno leather 05 latte with mat ardesia frame, boxes with lid covered in fabric ardesia. In the centre, Fitted leaf doors in transparent reflecting glass with frame and handles in mat ardesia. Set-up island chest of drawers with structure in ardesia mat lacquer and upper shelf in fumé glass and techno leather 05 latte, drawers with fronts in fumé reflecting glass, mat ardesia Track handle. Open compartment with shelf in fumé glass, shelf and drawers bottom in techno leather 05 latte. Henry pouf in black elm, seat in non-removable leather Nabuk 09 ruggine. Carpet Tratto ruggine. Jane Large armchair in removable fabric Sendai 03 fango and black elm base. To the left: close up of the showcase chests of drawers with top in fumé glass, drawer with bevelled front in ardesia mat lacquer and shelf in techno leather 05 latte. Lower drawers with fronts in fumé reflecting glass, edge and Track handle in mat ardesia, shelves in techno leather 05 latte.



In questa pagina: dettaglio del fianco a telaio in ardesia opaco e dello schienale in metacrilato roller latte. Ripiano in tecnopelle 05 latte con telaio in ardesia opaco e tubo appendiabiti rivestito in tecnopelle 05 latte e ardesia opaco.

This page: close up of the frame side in mat ardesia and of the back in methacrylate roller latte. Shelf in techno leather 05 latte with frame in mat ardesia, hanging bar covered in techno leather 05 latte and mat ardesia.



INTERIOR 14

Senzafine cabina armadio

h 2590 p 584
Struttura: nobilitato ardesia.
Schienali: metacrilato roller latte.
Fianco telaio centrale: ardesia opaco.
Attrezzatura: nobilitato ardesia, vetro fumé 3050, vetro riflettente fumé 5059, tecnopelle 05 latte.
Parti metalliche: ardesia opaco.

Fitted ante

Apertura: battente.
Ante: vetro trasparente riflettente 5000 con telaio ardesia opaco.
Maniglie: Fitted ardesia opaco.

Senzafine walk-in closet

h 102" d 23"
Structure: ardesia melamine.
Backs: methacrylate roller latte.
Central frame side: mat ardesia.
Equipment: ardesia melamine, fumé glass 3050, fumé reflecting glass 5059, techno leather 05 latte.
Metal parts: mat ardesia.

Fitted doors

Opening: leaf doors.
Doors: transparent reflecting glass 5000 with mat ardesia frame.
Handles: Fitted mat ardesia.

Senzafine

Design R&D Poliform

Fitted

Design Rodolfo Dordoni

Cassettiera a vetrina - Showcase chest of drawers

Design Rodolfo Dordoni

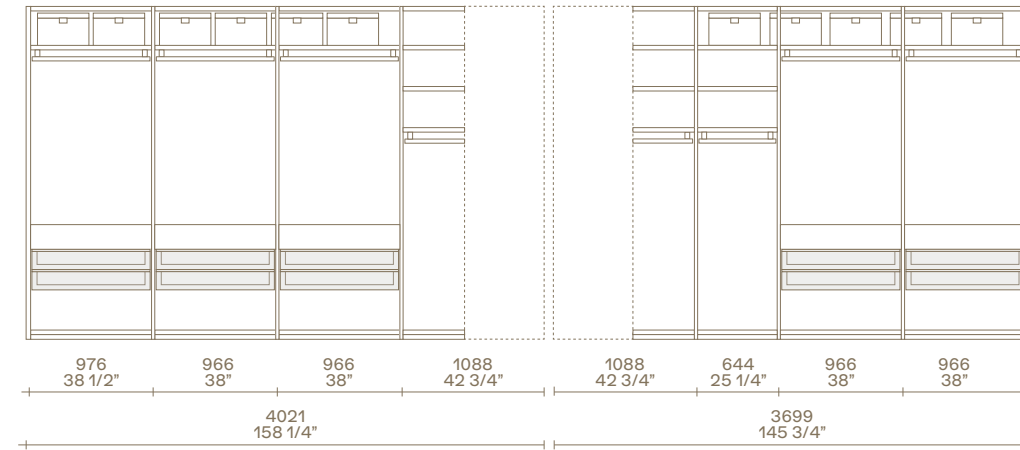





Nelle pagine precedenti: cabina armadio Senzafine con struttura in nobilitato rovere cenere. Ripiani in nobilitato rovere cenere, vetro fumé e tecnopelle 01 elefante con telaio ardesia opaco e luce led integrata. Pouf Gant in pelle non sfoderabile Nabuk 01 latte. Tavolino Tribeca in brown nickel opaco e piano in marmo emperador dark lucido. Tappeto Dama. A destra: dettaglio della cassettiere in nobilitato rovere cenere con maniglie Step, piano superiore in tecnopelle 01 elefante e telaio ardesia opaco. Svuotatasche estraibile in laccato opaco ardesia con piano superiore, vaschette, porta orologi e porta gioielli in pelle grigia. Ripiani in vetro fumé con telaio ardesia opaco. Sotto: dettaglio della maniglia Step in tecnopelle 01 elefante e ardesia opaco.

Previous pages: Senzafine walk-in closet with structure in cenere oak melamine. Shelves in cenere oak melamine, fumé glass and techno leather 01 elefante with frame mat ardesia, integrated led light. Gant pouf in non-removable leather Nabuk 01 latte. Tribeca coffee table in mat brown nickel and top in glossy marble emperador dark. Carpet Dama. To the right: close up of the chests of drawers in melamine cenere oak with Step handles, top shelf in techno leather 01 elefante and mat ardesia frame. Ardesia mat lacquered pull-out jewellery tray with top shelf, open cases, watchcase and jewellery case in grey leather. Shelves in fumé glass with mat ardesia frame. Below: close up of the Step handle in techno leather 01 elefante and mat ardesia.



In questa pagina: dettaglio del vassoio in nobilitato rovere cenere attrezzato con vaschette rivestite in pelle grigia, maniglia Step in tecnopelle 01 elefante e ardesia opaco. Porta pantaloni in nobilitato rovere cenere. Ripiani in tecnopelle 01 elefante con telaio ardesia opaco.

This page: close up of the tray in cenere oak melamine accessorized with cases covered in grey leather, Step handle in techno leather 01 elefante and mat ardesia. Trousers hanger in cenere oak melamine. Shelves in techno leather 01 elefante with mat ardesia frame.



INTERIOR 15

Senzafine cabina armadio

h 2590 p 584

Struttura: nobilitato rovere cenere.

Schienali: nobilitato rovere cenere.

Attrezzatura: nobilitato rovere cenere,
vetro fumé 3050, tecnopelle

01 elefante.

Parti metalliche: ardesia opaco.

Senzafine walk-in closet

h 102" d 23"

Structure: cenere oak melamine.

Backs: cenere oak melamine.

Equipment: cenere oak melamine,
fumé glass 3050, techno leather

01 elefante.

Metal parts: mat ardesia.

Senzafine

Design R&D Poliform

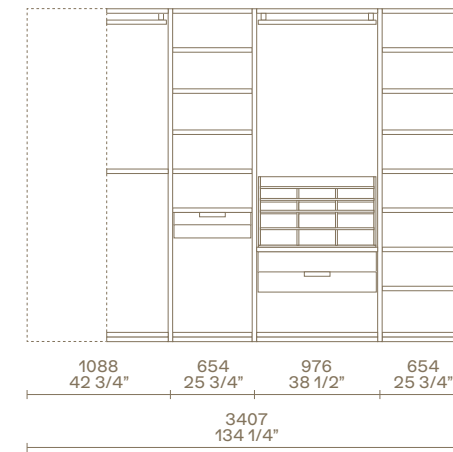
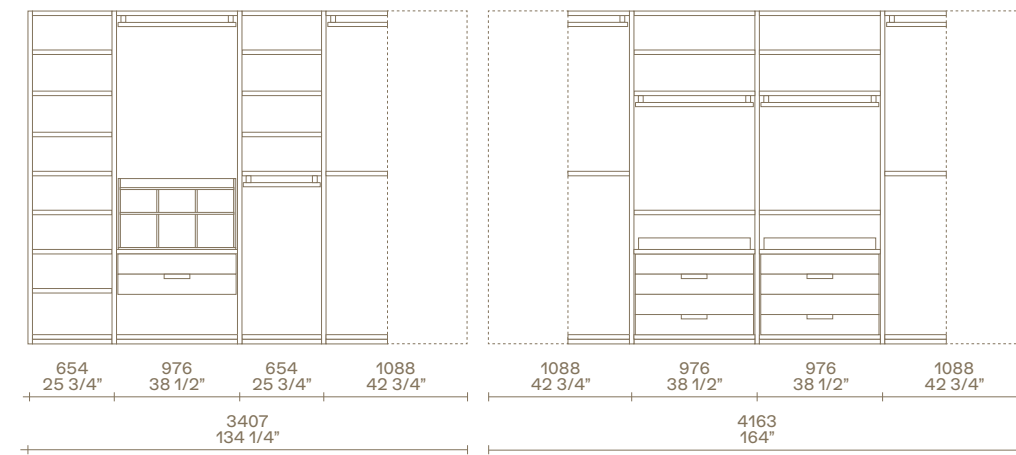

SENZAFINE ARMADI E CABINA ARMADIO SENZAFINE WARDROBES AND WALK-IN CLOSET

Un sistema armadi e cabina armadio progettato con una modularità evoluta, in grado di inserirsi in ogni spazio.

La cabina armadio è caratterizzata dai fianchi di spessore mm 35, che ne sottolineano la solidità formale e il rigore geometrico. Il fianco telaio e il fianco telaio vetro (spessore mm 25), permettono di creare armadi e cabine armadio di grande leggerezza formale e di definire composizioni armadio caratterizzate dagli interni "aperti".

Il sistema propone un'organizzazione evoluta degli interni. Sono disponibili fasce di tamponamento orizzontali o verticali, elementi terminali e per composizioni ad angolo, con cambi di profondità, a ponte o con passaggi porta. Sono previsti tagli a misura in larghezza, altezza e profondità.

A wardrobes and a walk-in closet system with a contemporary modularity, suitable to any space.

The walk-in closet is distinguished by vertical panels of 1 1/2" that bring out the solidity of shapes and the geometry. The frame side and the glass frame side (thickness 1") allow to create great formal lightness walk-in closets and to realize wardrobes characterized by inner open units.

Senzafine system proposes an advanced organization of the internal parts of the cabinets. Horizontal or vertical filler pieces are available, end and corner units, changes in depth, bridge units and door passages. Customizations in width, height and depth are available.

Cabina armadio fianco spessore mm 35

Per ottenere la larghezza totale, aggiungere alla somma delle colonne mm 35 relativi al fianco laterale.

Walk-in closet side thickness 1 1/2"

To obtain the total width, add to the sum of the columns 1 1/2" for the lateral side.

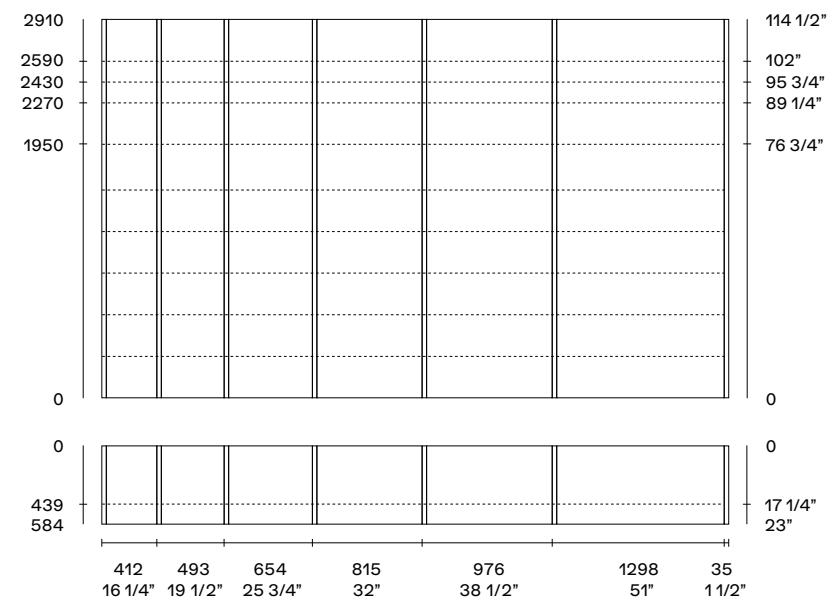

Tipologie di apertura degli armadi Wardrobes opening typologies

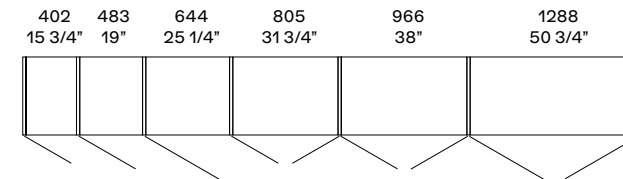

Battente
Leaf door

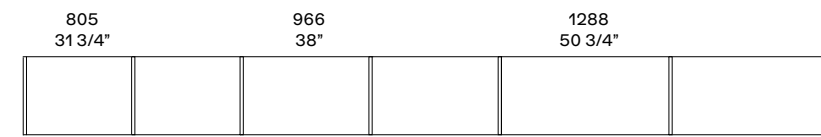

Scorrevole
Sliding door

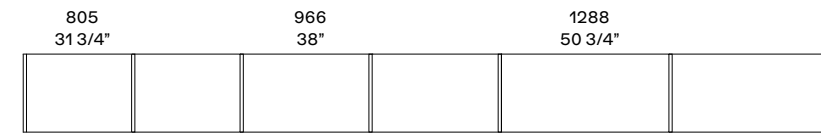

Complanare
Coplanar door

Armadi e cabina armadio fianco spessore mm 25

Per ottenere la larghezza totale, aggiungere alla somma delle colonne mm 25 relativi al fianco laterale.

Wardrobes and walk-in closet side thickness 1"

To obtain the total width, add to the sum of the columns 1" for the lateral side.

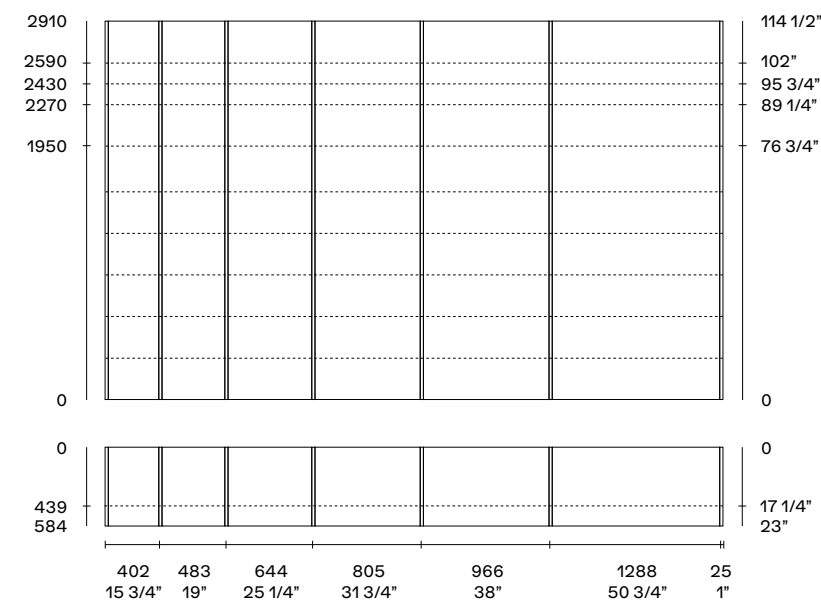

SEZAFINE ORGANIZZAZIONE DEGLI INTERNI
SEZAFINE INNER ORGANISATION

Attrezzature armadi h 2590

- | | | |
|--|---|---|
| <p>1 1 ripiano
1 tubo appendiabiti
Vassoio portaoggetti
Cassettiera sospesa 2 cassetti vetro, maniglia Track</p> <p>2 1 tubo appendiabiti
1 svuotatasche
Portapantaloni con vassoio portaoggetti, maniglia Track</p> <p>3 1 tubo appendiabiti
Contentore portacamicie con cassetti alti e bassi rivestiti in tessuto
Cassettiera a terra 4 cassetti legno, maniglia Step</p> <p>4 4 ripiani
4 scatole larghezza mm 400
3 ripiani portascarpe inclinati</p> | <p>5 1 ripiano
1 tubo appendiabiti
Cassettiera a vetrina
Cassettiera a terra 4 cassetti legno, maniglia Track</p> <p>6 1 ripiano
3 scatole larghezza mm 260
1 tubo appendiabiti
Cassettiera a vetrina
Cassettiera sospesa 2 cassetti vetro, maniglia Track
2 scatole larghezza mm 400</p> <p>7 1 servetto
Camciera con 2 vassoi
1 ripiano
1 tubo appendiabiti</p> | <p>8 1 ripiano
1 tubo appendiabiti
Cassettiera a terra 1 cassetto alto legno, maniglia Track e 2 vassoi</p> <p>9 4 ripiani
4 scatole larghezza mm 400
3 vassoi portascarpe estraibili per cabina armadio</p> <p>10 1 tubo appendiabiti
Contentore portaborse
Cassettiera a terra 4 cassetti vetro, maniglia Track</p> <p>11 1 ripiano
2 tubi appendiabiti</p> <p>12 3 ripiani
1 tubo appendiabiti
Contentore porta scarpe con cassetti rivestiti in tessuto</p> |
|--|---|---|

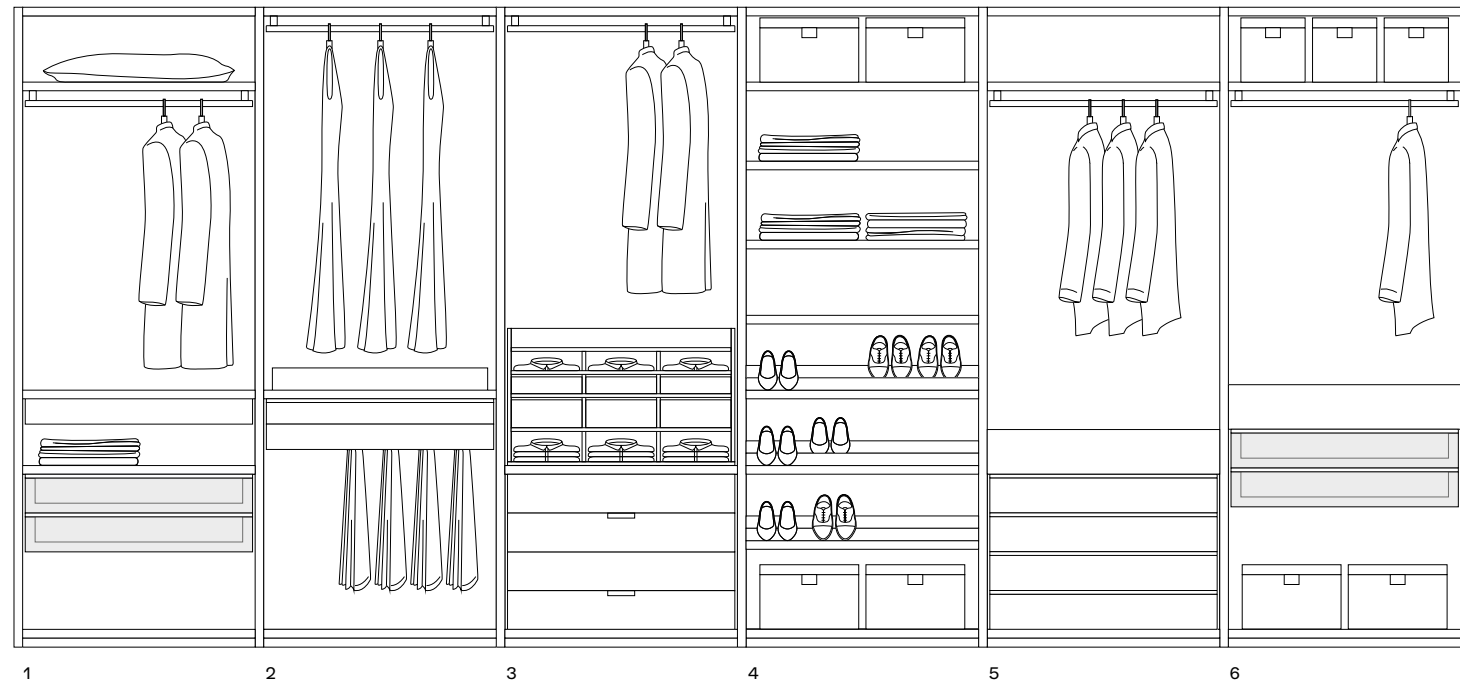

Wardrobes equipment h 102"

- | | | |
|---|--|---|
| <p>1 1 shelf
1 hanging rail
Storage tray
Hanging chest of drawers with 2 glass drawers, Track handle</p> <p>2 1 hanging rail
1 jewellery tray
Trousers hanger with storage tray, Track handle</p> <p>3 1 hanging rail
Shirts storage with high and low drawers covered in fabric
Freestanding chest of drawers with 4 wooden drawers, Step handle</p> <p>4 4 shelves
4 boxes width 15 3/4"
3 inclined shoes shelves</p> | <p>5 1 shelf
1 hanging rail
Showcase chest of drawers
Freestanding chest of drawers with 4 wooden drawers, Track handle</p> <p>6 1 shelf
3 boxes width 10 1/4"
1 hanging rail
Showcase chest of drawers
Hanging chest of drawers with 2 glass drawers, Track handle
2 boxes width 15 3/4"</p> <p>7 1 pull down hanging bar
Pull out shirts storage with 2 trays
1 shelf
1 hanging rail</p> | <p>8 1 shelf
1 hanging rail
Freestanding chest of drawers with 1 high wooden drawer, Track handle and 2 trays</p> <p>9 4 shelves
4 boxes width 15 3/4"
3 pull out shoes trays for walk-in closet</p> <p>10 1 hanging rail
Handbags storage
Freestanding chest of drawers with 4 glass drawers, Track handle</p> <p>11 1 shelf
2 hanging rails</p> <p>12 3 shelves
1 hanging rail
Shoes storage with drawers covered in fabric</p> |
|---|--|---|

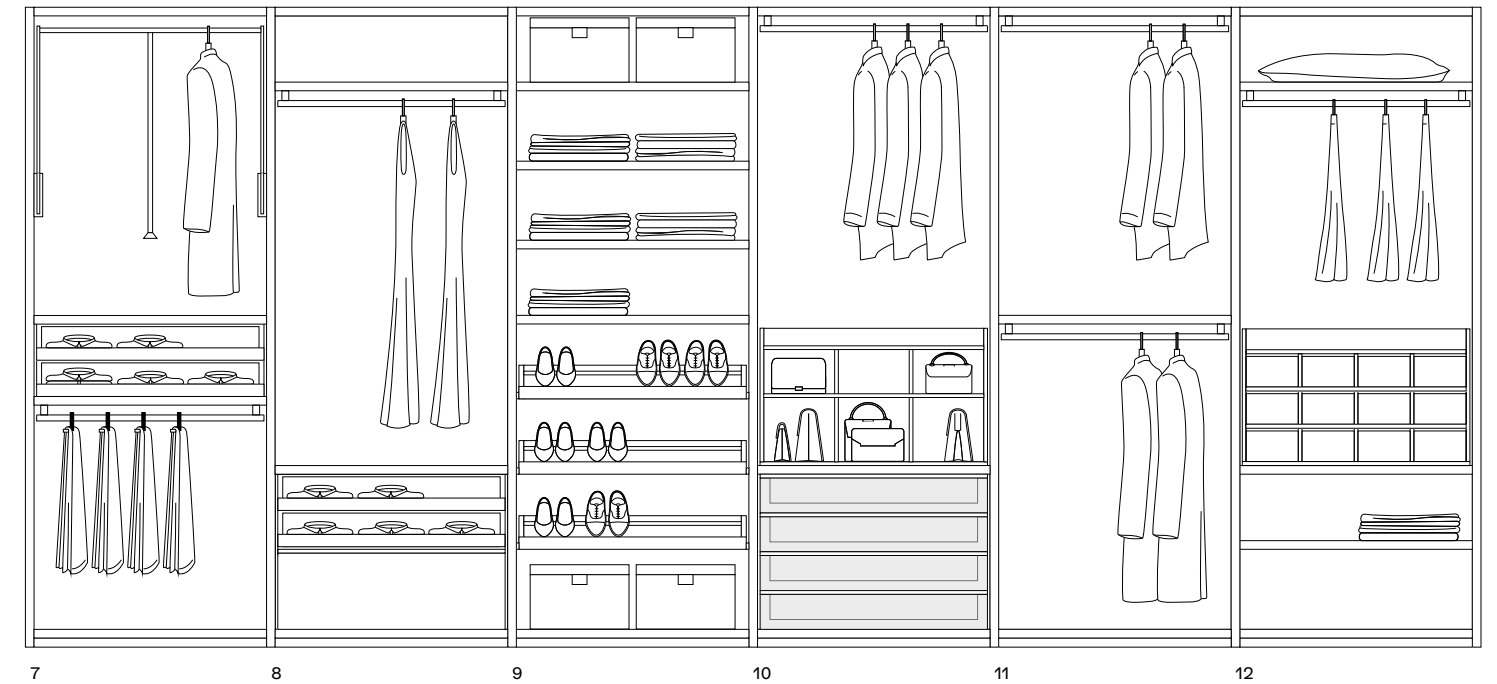

SENZAFINE CLUB
Design R&D Poliform

Aperture

- B Battente
- S Scorrevole
- C Coplanare
- CS Cassetti esterni

Finiture anta

Nobilitato club bianco 01

Openings

- B Leaf door
- S Sliding door
- C Coplanar door
- CS External drawers

Door finishings

Club melamine bianco 01

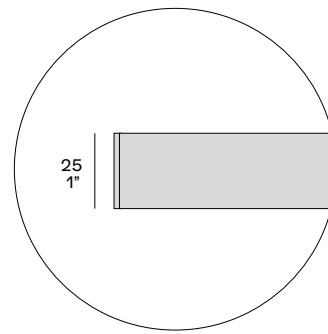

SENZAFINE GRAFFITI
Design R&D Poliform

Aperture

- B Battente
- S Scorrevole
- C Coplanare
- CS Cassetti esterni

Finiture anta

Nobilitato graffiti bianco 01
Nobilitato graffiti canapa 35
Nobilitato graffiti ghiaccio 60
(texture orizzontale)

Openings

- B Leaf door
- S Sliding door
- C Coplanar door
- CS External drawers

Door finishings

Graffiti melamine bianco 01
Graffiti melamine canapa 35
Graffiti melamine ghiaccio 60
(horizontal texture)

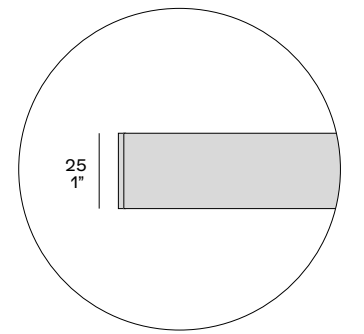

SENZAFINE SAND
Design R&D Poliform

Aperture

- B Battente
- S Scorrevole
- C Coplanare
- CS Cassetti esterni

Finiture anta

- Nobilitato olmo
- Nobilitato noce c.
- Nobilitato rovere cenere
- Nobilitato rovere spessart (texture verticale)

Openings

- B Leaf door
- S Sliding door
- C Coplanar door
- CS External drawers

Door finishings

- Elm melamine
- Walnut c. melamine
- Cenere oak melamine
- Spessart oak melamine (vertical texture)

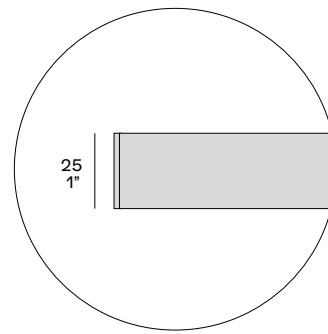

SENZAFINE CANVAS
Design R&D Poliform

Aperture

- B Battente
- S Scorrevole
- C Coplanare
- CS Cassetti esterni

Finiture anta

- Nobilitato canvas beige
- Nobilitato canvas grigio (texture verticale)

Bordo perimetrale

- abs applicato laser
- colore ardesia
- colore champagne

Openings

- B Leaf door
- S Sliding door
- C Coplanar door
- CS External drawers

Door finishings

- Canvas beige melamine
- Canvas grigio melamine (vertical texture)

Perimeter edge

- abs laser-applied
- colour ardesia
- colour champagne

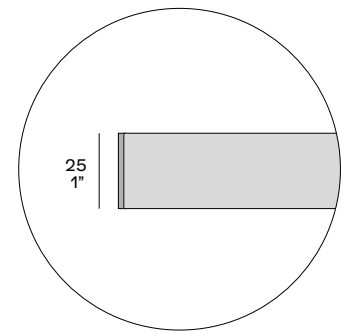

SENZAFINE SILK

Design R&D Poliform

Aperture

- B Battente
- S Scorrevole
- C Coplanare
- CS Cassetti esterni

Finiture anta

- Nobilitato silk canapa
- Nobilitato silk grey
- Nobilitato silk bronzo (texture verticale)

Openings

- B Leaf door
- S Sliding door
- C Coplanar door
- CS External drawers

Door finishings

- Silk canapa melamine
- Silk grey melamine
- Silk bronzo melamine (vertical texture)

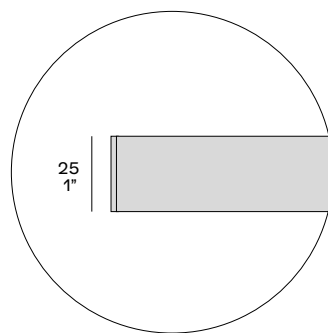

SENZAFINE SKIN

Design R&D Poliform

Aperture

- B Battente
- S Scorrevole
- C Coplanare

Finiture anta

- Nobilitato skin laccato opaco colori
- Nobilitato skin laccato opaco nei colori: 94 latte, 97 elefante, 93 moro, 98 nocciola

Finiture profilo

- Ardesia opaco
- Champagne opaco
- Laccato opaco colori
- Laccato opaco nei colori: 94 latte, 97 elefante, 93 moro, 98 nocciola

Openings

- B Leaf door
- S Sliding door
- C Coplanar door

Door finishings

- Skin melamine mat lacquered colours
- Skin melamine mat lacquered in colours: 94 latte, 97 elefante, 93 moro, 98 nocciola

Profile finishings

- Mat ardesia
- Mat champagne
- Mat lacquered colours
- Mat lacquered in the colours: 94 latte, 97 elefante, 93 moro, 98 nocciola

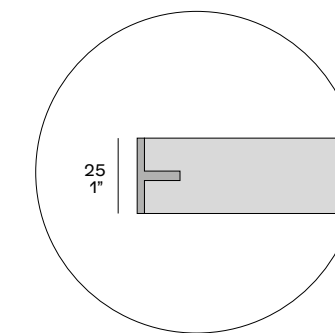

SENZAFINE NEW ENTRY

Design R&D Poliform

Aperture

- B Battente
- S Scorrevole
- C Coplanare
- CS Cassetti esterni

Finiture anta

- Laccato opaco colori
- Laccato semilucido colori
- Laccato lucido colori
- Laccato metallico colori (texture verticale)
- Noce gold (venatura orizzontale)
- Rovere spessart (venatura orizzontale)
- Olmo nero (venatura orizzontale)

Openings

- B Leaf door
- S Sliding door
- C Coplanar door
- CS External drawers

Door finishings

- Mat lacquered colours
- Semi-glossy lacquered colours
- Glossy lacquered colours
- Metallic lacquered colours (vertical texture)
- Gold walnut (horizontal grain)
- Spessart oak (horizontal grain)
- Black elm (horizontal grain)

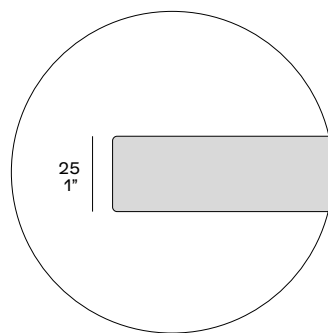

SENZAFINE PLUS

Design R&D Poliform

Aperture

- B Battente
- C Coplanare

Finiture anta

- Laccato opaco colori
- Laccato semilucido colori
- Laccato metallico colori (texture verticale)
- Noce gold (venatura verticale)
- Rovere spessart (venatura verticale)
- Olmo nero (venatura verticale)

Finiture maniglia Plus integrata

- Ardesia opaco
- Champagne opaco
- Brown nickel satinato
- Laccato opaco colori

Openings

- B Leaf door
- C Coplanar door

Door finishings

- Mat lacquered colours
- Semi-glossy lacquered colours
- Metallic lacquered colours (vertical texture)
- Gold walnut (vertical grain)
- Spessart oak (vertical grain)
- Black elm (vertical grain)

Integrated Plus handle finishings

- Mat ardesia
- Mat champagne
- Brushed brown nickel
- Mat lacquered colours

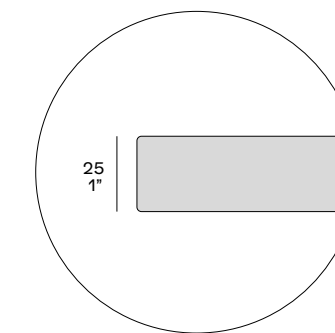

SENZAFINE MADISON

Design Carlo Colombo

Aperture

B Battente

Finiture anta

Rovere spessart (venatura orizzontale)

Openings

B Leaf door

Door finishings

Spessart oak (horizontal grain)

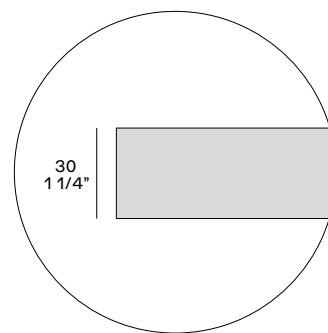

SENZAFINE STRATUS

Design Giuseppe Bavuso

Aperture

B Battente

S Scorrevole

C Coplanare

Finiture anta

Rovere spessart (venatura verticale)

Noce gold (venatura verticale)

Maniglia - finiture

Rail ardesia opaco

Rail champagne opaco

Rail laccato opaco colori

Openings

B Leaf door

S Sliding door

C Coplanar door

Door finishings

Spessart oak (vertical grain)

Gold walnut (vertical grain)

Handle - finishings

Rail mat ardesia

Rail mat champagne

Rail mat lacquered colours

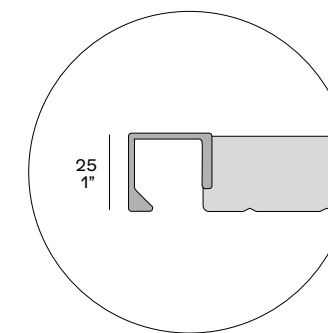

SENZAFINE EGO
Design Giuseppe Bavuso

Aperture
B Battente

Finiture anta
Vetro trasparente 1000
Vetro trasparente riflettente 5000
Vetro fumé 3050
Vetro riflettente bronzato 5051
Vetro line 2700

Finiture telaio e maniglia Ego
Ardesia opaco
Champagne opaco
Laccato opaco colori

Openings
B Leaf door

Door finishings
Transparent glass 1000
Transparent reflecting glass 5000
Fumé glass 3050
Bronzed reflecting glass 5051
Line glass 2700

Frame and Ego handle finishings
Mat ardesia
Mat champagne
Mat lacquered colours

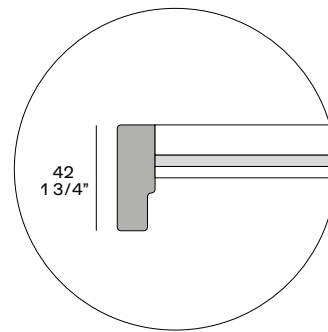

SENZAFINE FITTED
Design Rodolfo Dordoni

Aperture
B Battente

Finiture anta
Vetro trasparente extrachiaro 2000
Vetro trasparente riflettente 5000
Vetro fumé 3050
Vetro riflettente bronzato 5051

Finiture telaio e maniglia Fitted
Ardesia opaco
Champagne opaco
Laccato opaco colori

Per telaio ardesia opaco e laccato opaco colori serigrafia vetro color ferro.
Per telaio champagne opaco serigrafia vetro color champagne.

Openings
B Leaf door

Door finishings
Transparent extralight glass 2000
Transparent reflecting glass 5000
Fumé glass 3050
Bronzed reflecting glass 5051

Frame and Fitted handle finishings
Mat ardesia
Mat champagne
Mat lacquered colours

For mat ardesia mat lacquered colours frame glass screen-printing colour ferro.
For mat champagne frame glass screen-printing colour champagne.

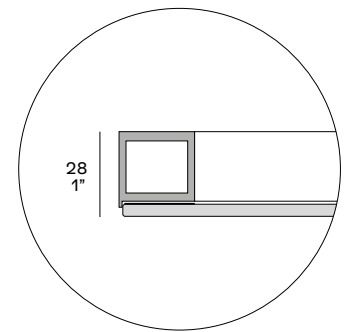

SENZAFINE OCEAN

Design R&D Poliform

Aperture

- B Battente
- S Scorrevole
- C Coplanare

Finiture anta

Vetro lucido 6 colori
Vetro satinato 6 colori
Vetro acidato 3 colori
Vetro riflettente blu 5010
Specchio bianco 4000
(anta battente con interno laccato stesso colore del telaio, anta coplanare con interno in nobilitato bianco)

Finiture telaio

Ardesia opaco
Champagne opaco
Laccato opaco colori

Openings

- B Leaf door
- S Sliding door
- C Coplanar door

Door finishings

Glossy glass 6 colours
Mat glass 6 colours
Etched glass 3 colours
Blu reflecting glass 5010
White mirror 4000
(leaf door with inner side in the same colour of the frame, coplanar door with inner side in white melamine)

Frame finishings

Mat ardesia
Mat champagne
Mat lacquered colours

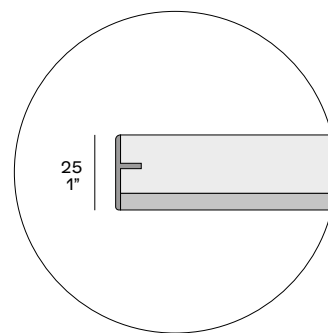

SENZAFINE COVER TECNOPELLE

Design R&D Poliform

Aperture

- B Battente
- C Coplanare

Finiture anta

Tecnopelle 4 colori

Finiture telaio e profili

Ardesia opaco
Champagne opaco

Maniglia - finiture

Cover - ardesia opaco e rivestita in tecnopelle 4 colori
Cover - champagne opaco e rivestita in tecnopelle 4 colori
Fitted - ardesia opaco
Fitted - champagne opaco

Openings

- B Leaf door
- C Coplanar door

Door finishings

Tecno leather 4 colours

Frame and profiles finishings

Mat ardesia
Mat champagne

Handle - finishings

Cover - mat ardesia and covered in techno leather 4 colours
Cover - mat champagne and covered in techno leather 4 colours
Fitted - mat ardesia
Fitted - mat champagne

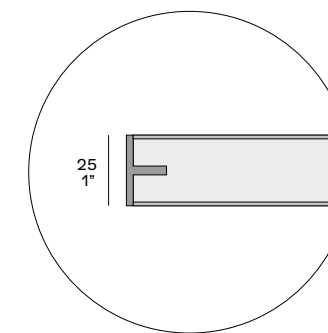

SENZAFINE COVER TESSUTO

Design R&D Poliform

Aperture

- B Battente
- C Coplanare

Finiture anta

Tessuto lino chiaro
Tessuto lino scuro

Finiture telaio e profili

Ardesia opaco
Champagne opaco

Maniglia - finiture

Fitted - ardesia opaco
Fitted - champagne opaco

Openings

- B Leaf door
- C Coplanar door

Door finishings

Fabric lino chiaro
Fabric lino scuro

Frame and profiles finishings

Mat ardesia
Mat champagne

Handle - finishings

Fitted - mat ardesia
Fitted - mat champagne

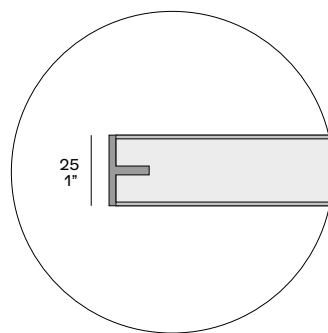

SENZAFINE COVER VETRO

Design R&D Poliform

Aperture

- B Battente
- C Coplanare

Finiture anta

Vetro lucido 6 colori
Vetro satinato 6 colori
Vetro acidato 3 colori
Vetro riflettente blu 5010
Specchio bianco 4000
(anta battente con interno laccato stesso colore del telaio, anta coplanare con interno in nobilitato bianco)

Finiture telaio e profili

Ardesia opaco
Champagne opaco

Maniglia - finiture

Fitted - ardesia opaco
Fitted - champagne opaco

Openings

- B Leaf door
- C Coplanar door

Door finishings

Glossy glass 6 colours
Mat glass 6 colours
Etched glass 3 colours
Blu reflecting glass 5010
White mirror 4000
(leaf door with inner side in the same colour of the frame, coplanar door with inner side in white melamine)

Frame and profiles finishings

Mat ardesia
Mat champagne

Handle - finishings

Fitted - mat ardesia
Fitted - mat champagne

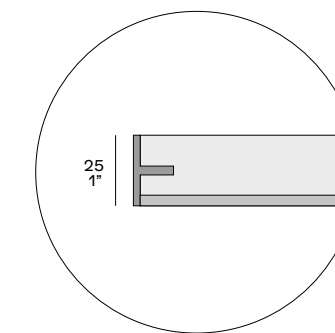

SENZAFINE BANGKOK

Design Operadesign

Aperture

- B Battente
- C Coplanare

Finiture anta

Cuoio colori

Finiture maniglia integrata

- Ardesia opaco
- Champagne opaco
- Brown nickel opaco
- Brown nickel lucido

Openings

- B Leaf door
- C Coplanar door

Door finishings

Hide colours

Integrated handle finishings

- Mat ardesia
- Mat champagne
- Mat brown nickel
- Glossy brown nickel

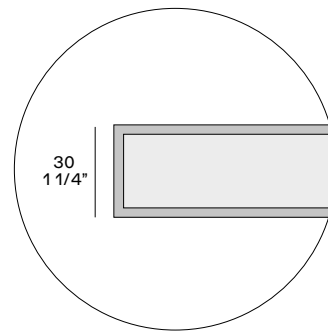

FINITURE SENZAFINE
SENZAFINE FINISHINGS

Struttura
Structure



olmo - elm
nobilitato - melamine



noce c. - walnut c.
nobilitato - melamine



rovere cenere
cenere oak
nobilitato - melamine



rovere spessart
spessart oak
nobilitato - melamine



canvas beige
nobilitato - melamine



canvas grigio
nobilitato - melamine



ardesia
nobilitato - melamine

Schienale
Back



olmo - elm
nobilitato - melamine



noce c. - walnut c.
nobilitato - melamine



rovere cenere
cenere oak
nobilitato - melamine



rovere spessart
spessart oak
nobilitato - melamine



canvas beige
nobilitato - melamine



canvas grigio
nobilitato - melamine

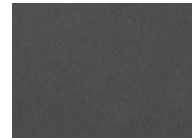

ardesia
nobilitato - melamine



roller latte
metacrilato
methacrylate

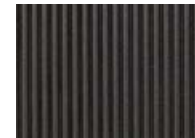

roller ardesia
metacrilato
methacrylate



skin
nobilitato - melamine
27 colori laccato opaco
27 mat lacquered colours

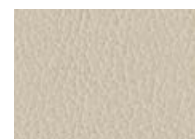

skin 94 latte
nobilitato - melamine
laccato opaco
mat lacquered

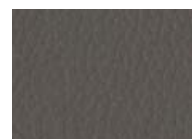

skin 97 elefante
nobilitato - melamine
laccato opaco
mat lacquered



skin 93 moro
nobilitato - melamine
laccato opaco
mat lacquered

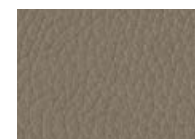

skin 98 nocciola
nobilitato - melamine
laccato opaco
mat lacquered

Schienale vetro e fianco vetro
Glass back and glass side

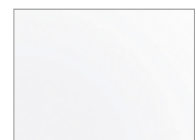

1000
trasparente
transparent



3050 fumé



2700 line

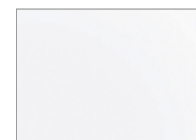

5000
trasparente riflettente
transparent reflecting



5051
bronzato riflettente
bronzed reflecting

Attrezzatura
Equipment



olmo - elm
nobilitato - melamine



noce c. - walnut c.
nobilitato - melamine



rovere cenere
cenere oak
nobilitato - melamine



rovere spessart
spessart oak
nobilitato - melamine



canvas beige
nobilitato - melamine



canvas grigio
nobilitato - melamine



ardesia
nobilitato - melamine

Ripiani tecnopelle
Techno leather shelves



05 latte
tecnopelle
techno leather

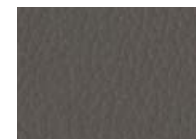

01 elefante
tecnopelle
techno leather



02 moro
tecnopelle
techno leather



06 nocciola
tecnopelle
techno leather

Ripiani vetro
Glass shelves



3050 fumé

Frontale cassetti
Drawers front



olmo - elm
nobilitato - melamine



noce c. - walnut c.
nobilitato - melamine



rovere cenere
cenere oak
nobilitato - melamine



rovere spessart
spessart oak
nobilitato - melamine

* Finitura roller anche per frontali
vassoi portaoggetti e portapan-
taloni degli elementi sospesi.
Finish roller also for trays and
trousers hangers fronts of the
hanging units.



canvas beige
nobilitato - melamine

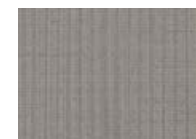

canvas grigio
nobilitato - melamine

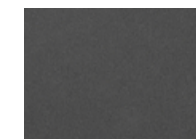

ardesia
nobilitato - melamine



roller latte
metacrilato
methacrylate *



roller ardesia
metacrilato
methacrylate *



5059
vetro riflettente fumé
fumé reflecting glass

Interno cassetti
Drawers interior



ardesia
nobilitato - melamine

Parti metalliche, ferramenta
Metal parts, hardware

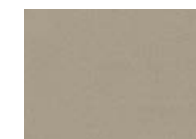

champagne opaco
mat champagne

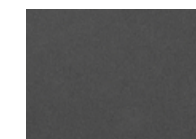

ardesia opaco
mat ardesia

FINITURE ANTE SENZAFINE
DOORS SENZAFINE FINISHINGS

Laccato opaco
Mat lacquered



Laccato lucido
Glossy lacquered

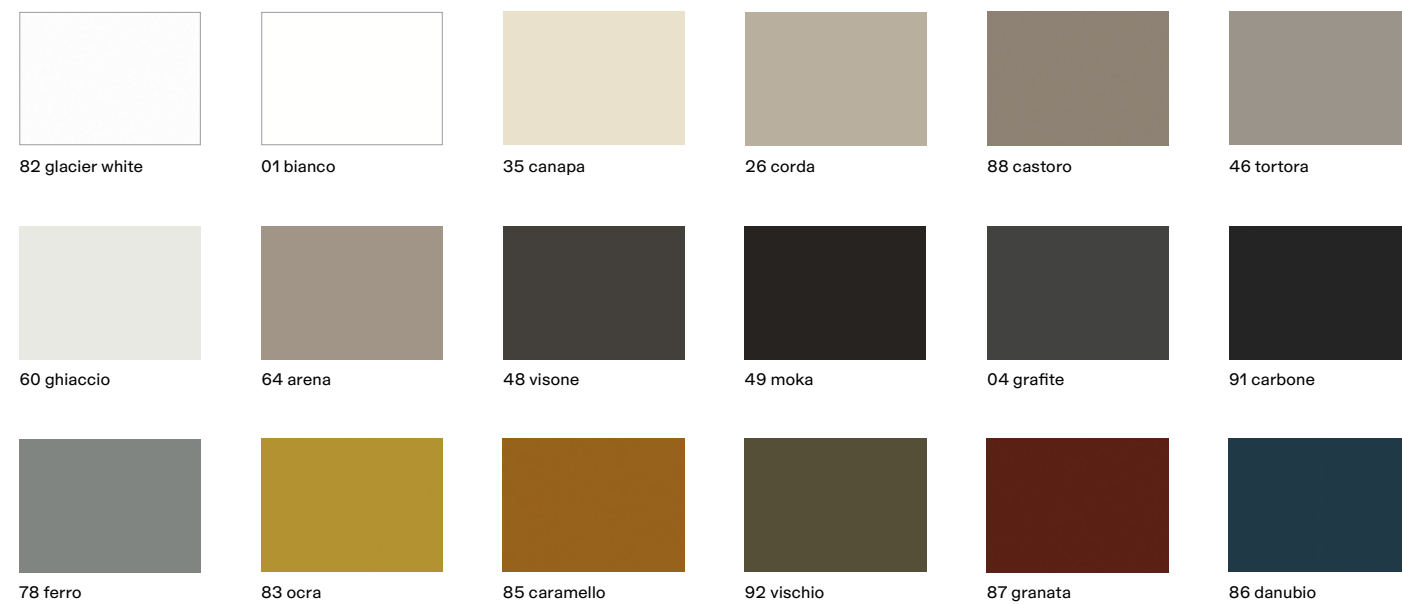

Laccato semilucido
Semi-glossy lacquered



Laccato metallico
Metallic lacquered



Essenza
Wood

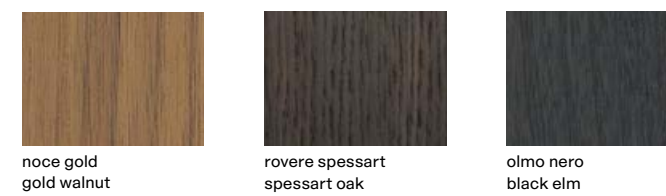

Nobilitato
Melamine

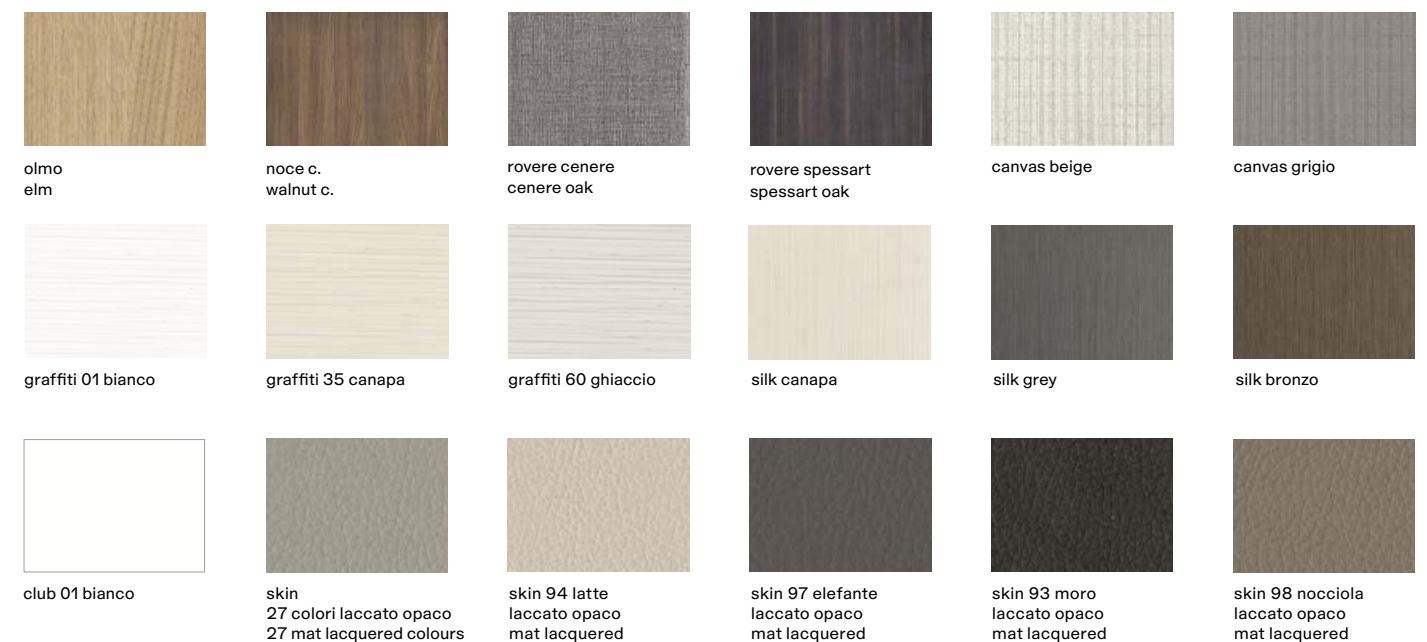

FINITURE ANTE SENZAFINE
DOORS SENZAFINE FINISHINGS

Tecnopelle
Techno leather



05 latte 01 elefante 02 moro 06 nocciola

Tessuto
Fabric



lino chiaro lino scuro

Cuoio
Hide



28 avorio 29 tortora 19 caffè 38 oliva 15 prugna 26 invecchiato



03 grigio scuro 02 nero

Vetro
Glass



1000 trasparente transparent
2000 trasparente extrachiaro-transparent extralight
3050 fumé
2700 line

Vetro riflettente
Reflecting glass

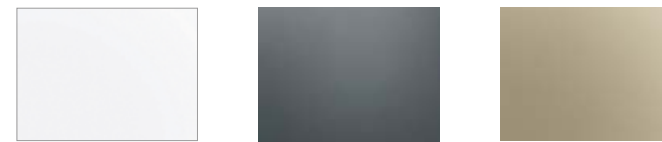

5000 trasparente transparent
5010 blu
5051 bronzato bronzed

Vetro acidato
Etched glass



5380 acciaio 5323 bronzo 5325 titanio

Specchio
Mirror

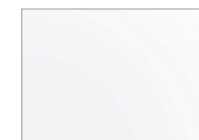

4000 bianco white

Vetro satinato
Mat glass



2301 bianco 2373 ghiaccio 1335 canapa 1364 arena 1304 grafite 1303 nero

Vetro lucido
Glossy glass



2201 bianco 2273 ghiaccio 1235 canapa 1264 arena 1204 grafite 1203 nero

Poliform Spa

via Montesanto 28
Casella postale n. 1
22044 Inverigo (CO) Italy
t +39 031 6951
f +39 031 699444
info@poliform.it
poliform.it

Poliform realizza tutte le sue collezioni in Italia usando componenti e materie prime selezionate.

All the Poliform collections are manufactured 100% in Italy using top-class components and materials.

Poliform si riserva il diritto di apportare, senza preavviso, ogni modifica mirata al miglioramento funzionale e qualitativo dei propri prodotti. Testi e disegni presenti in questo stampato hanno scopo divulgativo; per ogni aspetto tecnico e dimensionale fare riferimento ai listini aziendali e relativi aggiornamenti. I campioni di colori e materiali hanno valore indicativo.

Poliform reserves the rights at all time to apply modifications for the functional or qualitative improvement of its products. Texts and drawings present in this brochure have a divulgative purpose; for every technical and dimensional aspect please refer to the company's price lists and their relative updatings. The colour and material samples have an indicative value.



2018 Adi Compasso D'oro
Career Award