



????????

????????

?????

?????? ?????

12 ??

?????? ??????????

12 ??

???????? ???? ???? ?????

? ????????????????? ??????

???????? ???? ???? ???? ?

? ?????????? ????????? ?????? ? ??????

???????? ???? ???? ????? ???? ?

? ????????? ? ??????

???????? ???? ????????? ???? ?

? ????????? ????????? ????????? Tip-on ? ??????????

????????

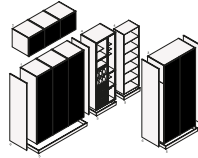
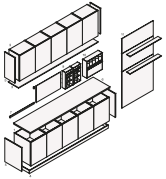

1 ??????

1 ??????

2 ??????

2 ??????? ? ? ????????

3 ????????? ???? ???? ???? ?

3 ??????? ???????

????????

4 ?????? ? ????

4 ???????, ??????? ????????

5 ???????, ??????? ????????

5 ??????? ???? ???? ??????????????

6 ??????? ???? ???? ?

????????

????????

6 ???????, ??????? ???????

7 ???????, ??????? ???????

8 ??????, ??????? ???????

9 ??????, ????????????? ???? ?

???????? ???????

10 Deep Shaker, ?????????????

?????, ??????? ???????

11 ?????? ? ???? ???? ?

????????

?????



???????? 12 ??.

???? ????????

???????? ?

?????? 12

???? ??. 410



?????? 150, 300, 450, 600

???????? ??. 410

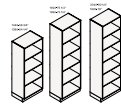

?????? 150, 300, 450, 600

???????? ????? ? . 410

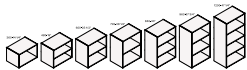

?????? 150, 300, 450, 600; ??????
606, 612, 622, 626 ???
????????????? ?????????? ? ??????
????????? 6, 12, 22, 26

???????? 26

?????? ??????? | 750 p 570

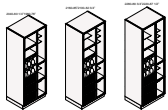

????? ??????? | 750 p 570

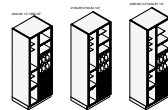

???????? 26 Trail

???? ? 300 ? 570



???????? | 300 p 570

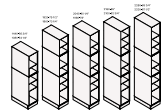

????????? ?????? ?? 300 ??????
402

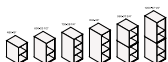

?? POLIFORM

?? Infinity

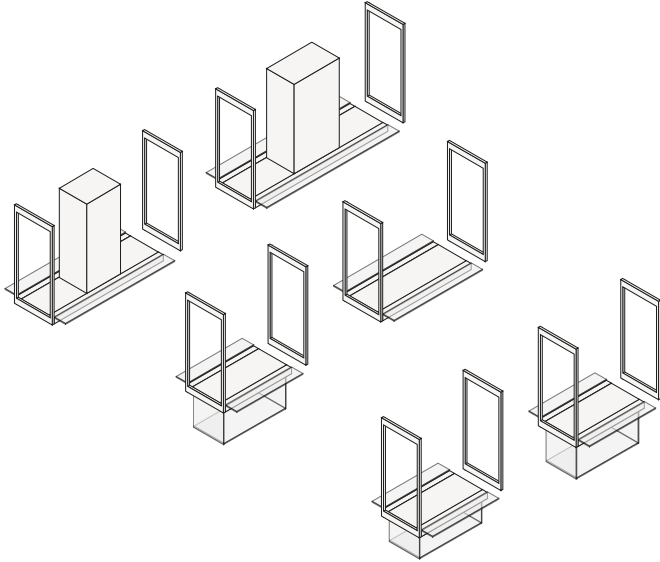

??

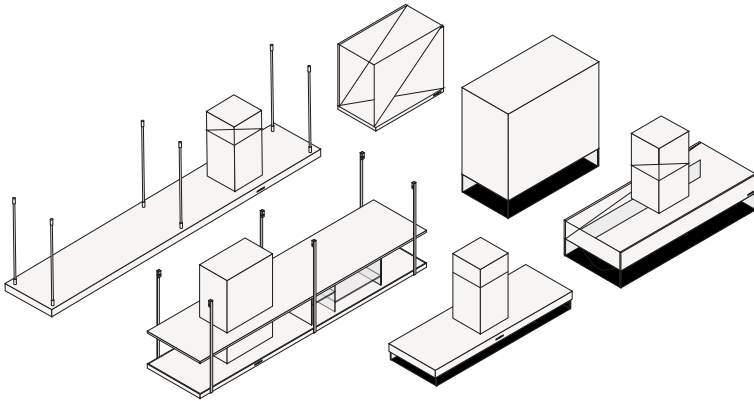

??

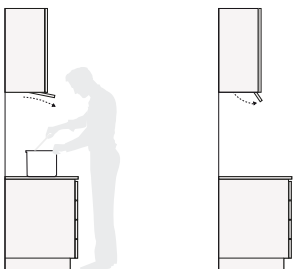

???????????????? ???????

Shaker

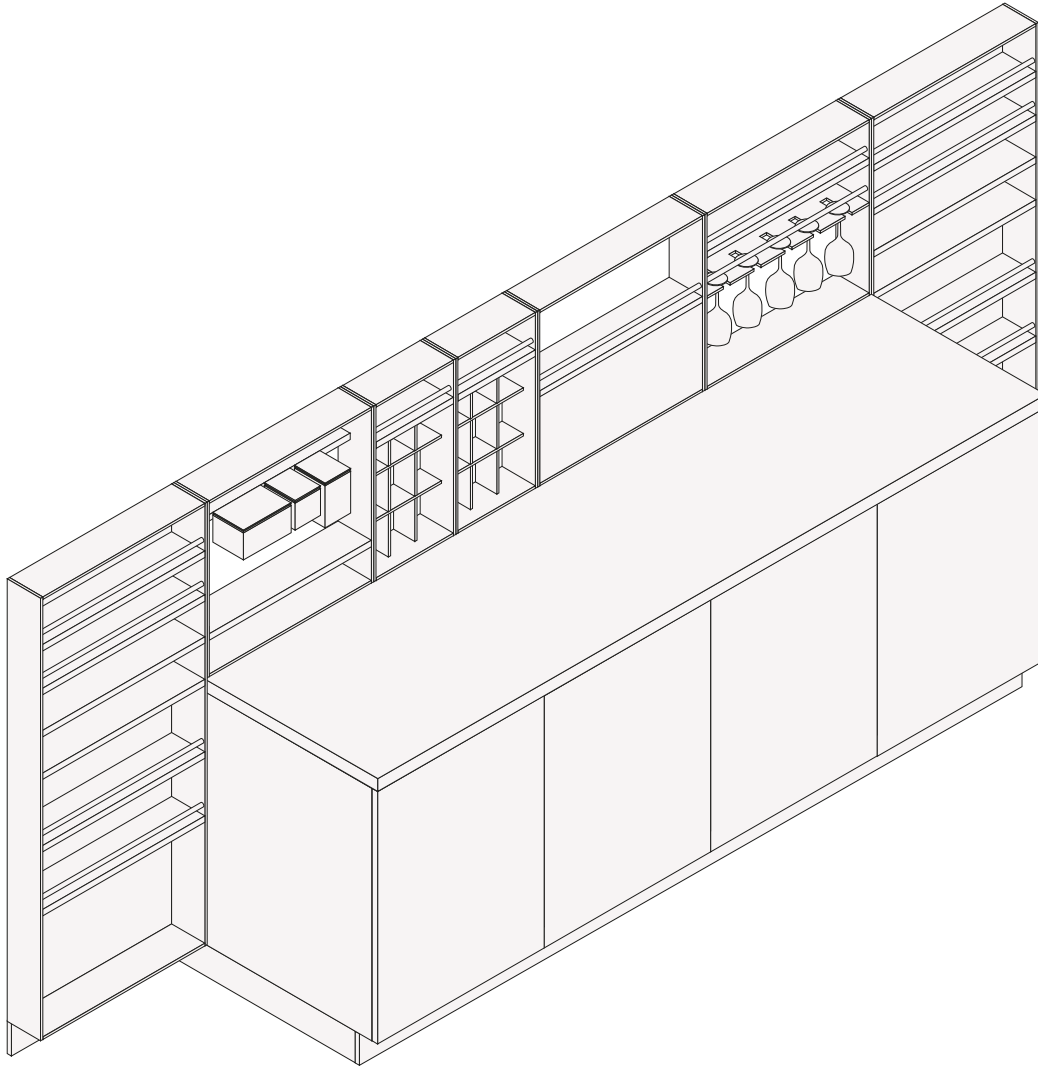

Deep Shaker

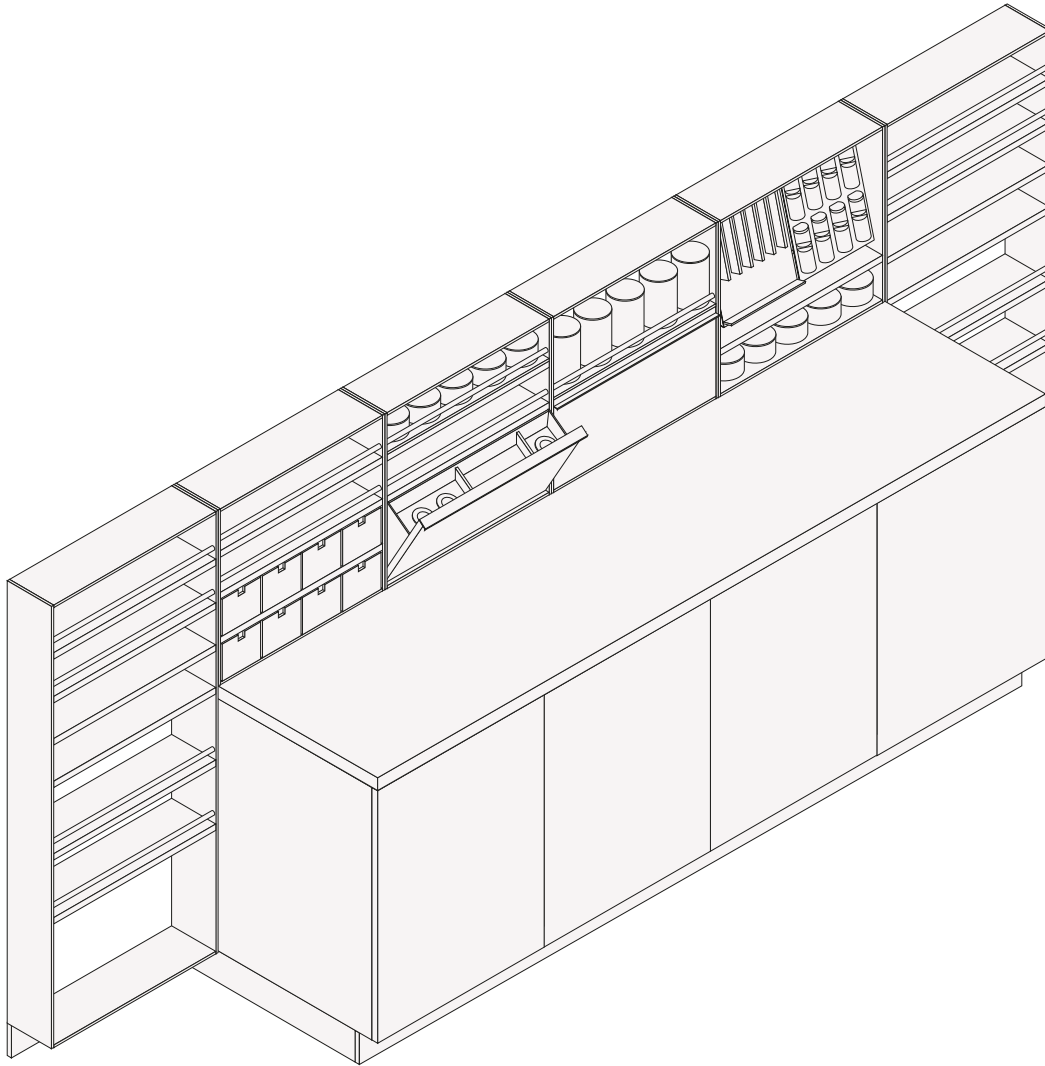

????????????? ??????

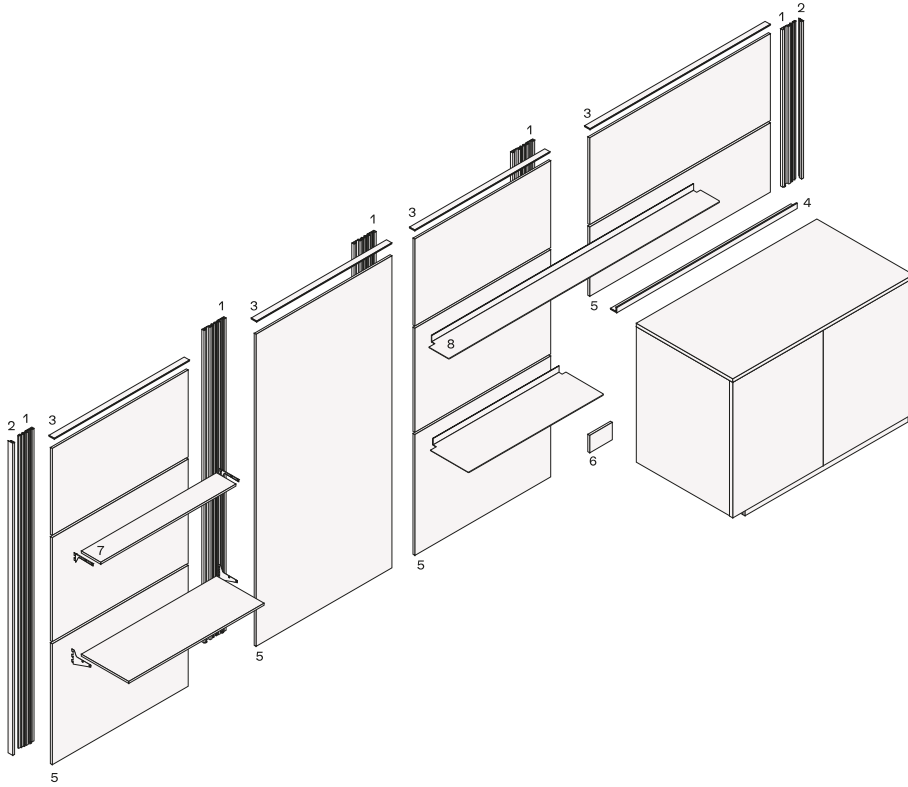

- 1 ????? ???? ?????????? ????????
- 2 ??????? ????????
- 3 ??????? ????????
- 4 ??????? ??????? ???? ?????????? ??????? ???????
- 5 ????????
- 6 ??????? 150 ? ??? ?????????? ??????? ????? ???????
- 7 ??????? ??????? 12
- 8 ??????? ??????? 3

?????? ? ? ? ? ? ? ? ? ? ? ? ? ? ? ? ?

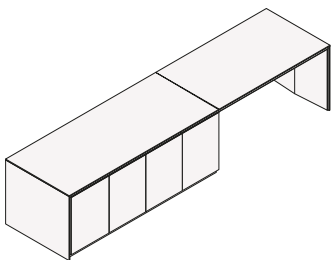
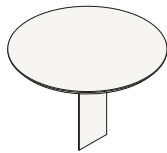
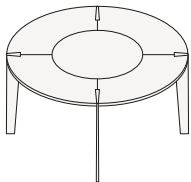
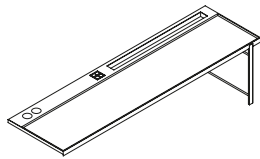
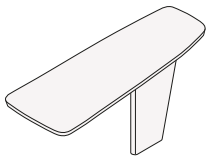
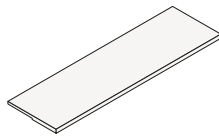
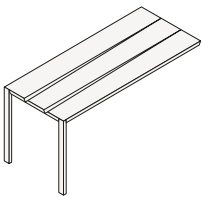
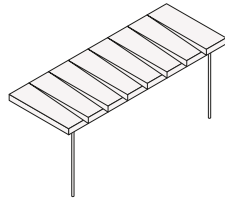
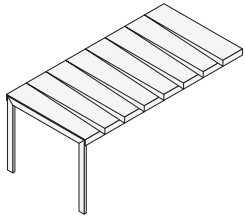

????????????

????????????????

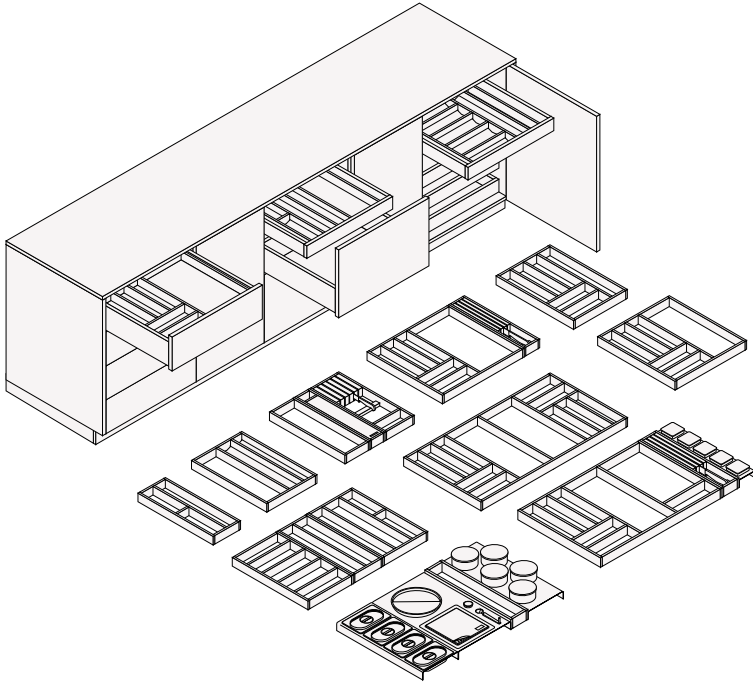

????????????????

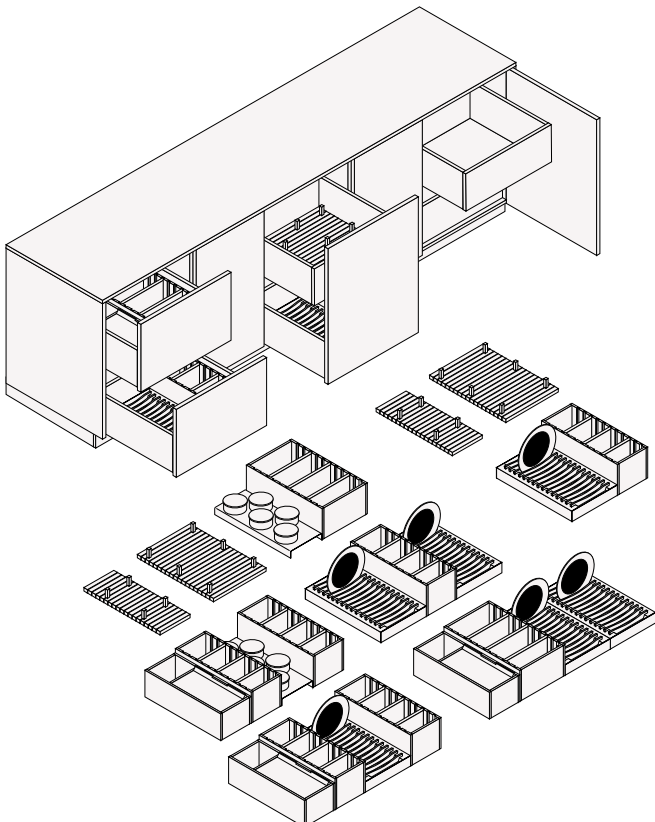

???????? ??????????

???????? ??????????????

???????? ?????????? ??????????????

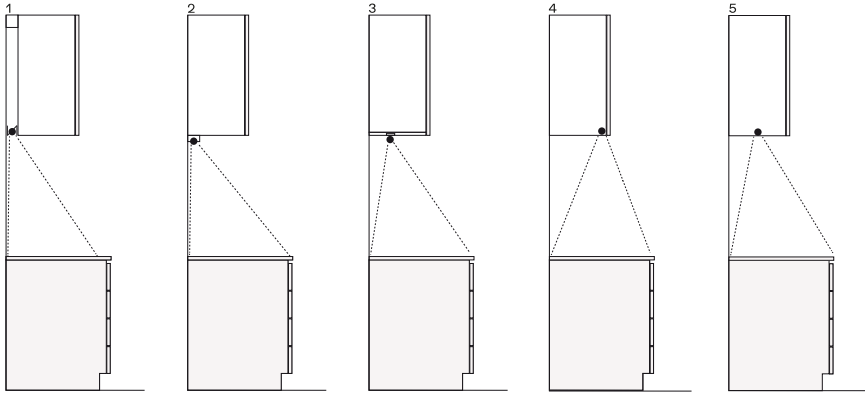

1 ????????? ?????? ????????? ?? ????????????, ?????????? ????????? ????????? 100 ??

2 ?????? ?????? ?? ????????? ???????

3 ?????? ? ?????????????? ??????????????

4 ????????? ??????? Multi-LED ?? ????????? ?????? ?? ????????? ?? ???????, ?????????????? ?????? ? ????????? ??????? d 410

5 ?????????????? ??????????, ????????????? ? ?????? ?????? ?????????? ??????

????????????

?????????? ?????????? ??? ???

1

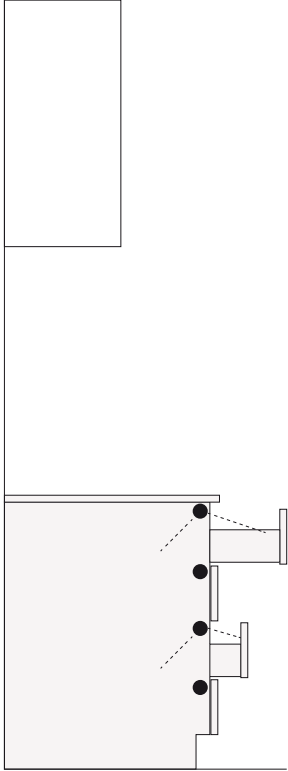

2

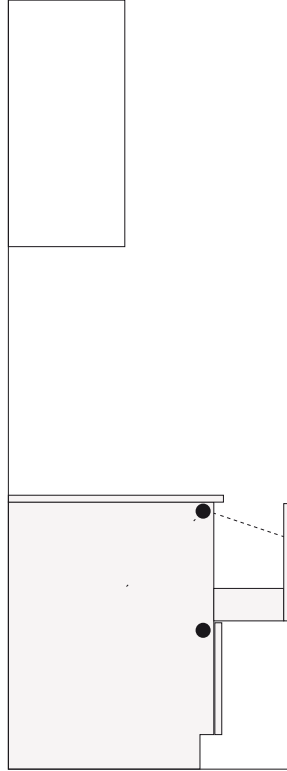

3

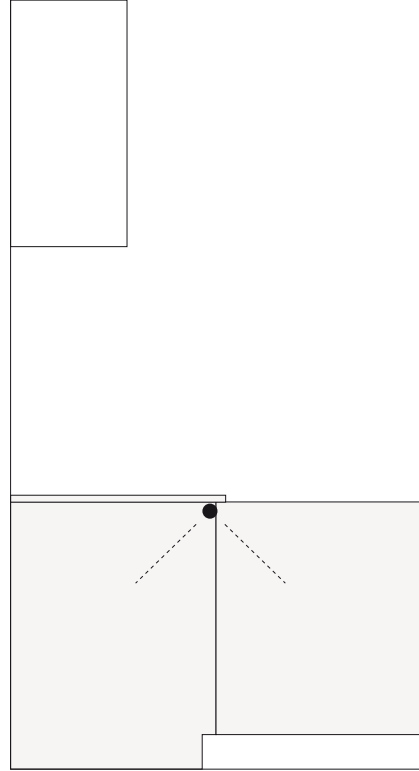

- 1 ??????? ? ?????????????? ?????? Kiton
- 2 ?????????????? ??? ?????????????????????? ????? Kiton
- 3 ?????????? ?????? ? ?????????????? ??????????? Kiton

????????? ? ?????????? ??????

?????????? ??????????? ? ? ? ? ? ? ? ? ? ? ?

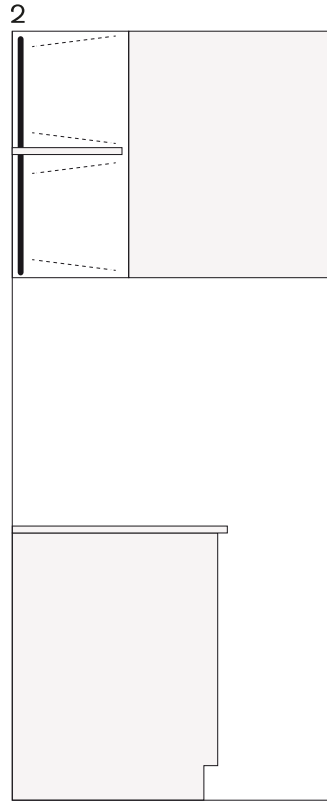
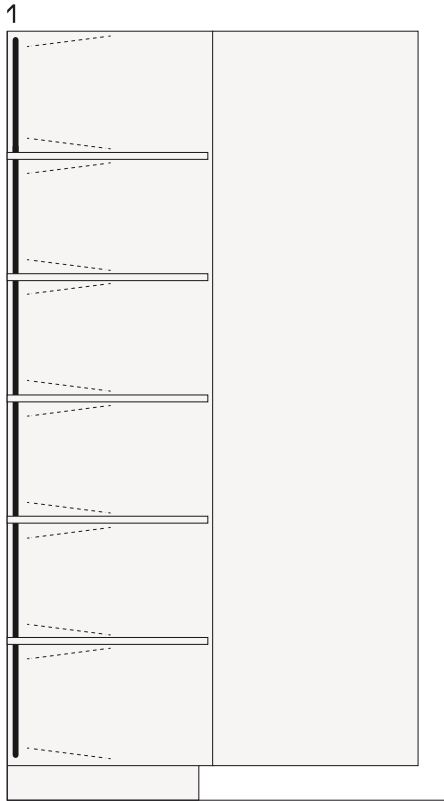

1 ?????? ? ??????????? ?????????????? ??????????????, h ?? 1320 ?? 2280
2 ?????? ? ?????????????? ?????????????? ??????????????, h ?? 360 ?? 1200

???????????????? ????????

?????????? ?????????? ?????????????? ???????

1

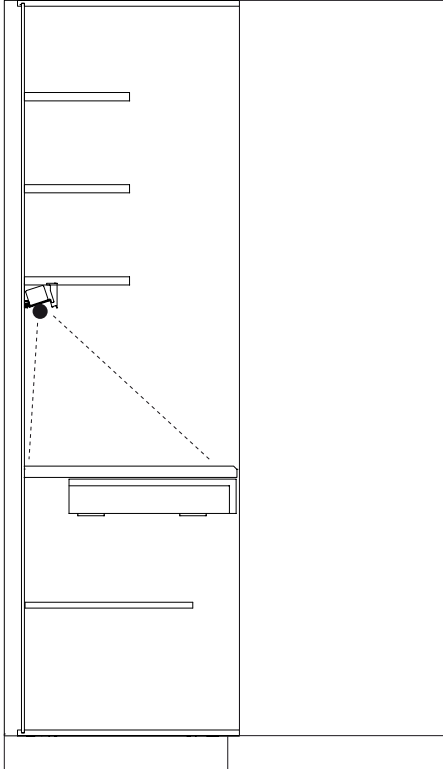

2

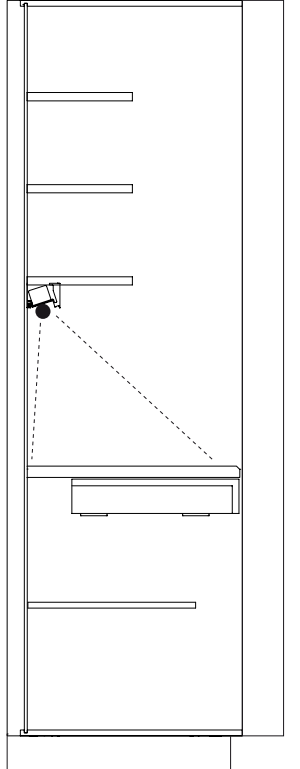

1 ??????? ? ????? ??????????? ? 900, 1200
2 ??????? ??????? ? ??????? ? ?????????? ??????, 1380 ?.