

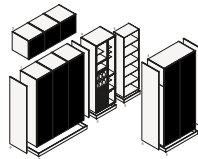

DESCRIPTION

Typology	Kitchen
Door thickness	12 mm
Top thickness	12 mm
Base units opening type	With profile
Tall units opening type	With profile and handle
Wall units opening type	With profile and handle
Tall units opening type	With handle tip-on and spacer

COMPONENTS

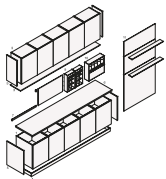

- 1 Base units
- 2 Wall units
- 3 Panel under wall unit, linear elements
- 4 Plinths, linear elements
- 5 Finishing sides, complementary elements
- 6 Tops, linear elements
- 7 Backsplashes, linear elements
- 8 Back panels, linear elements
- 9 Shaker, accessorized backs, linear elements
- 10 Deep Shaker, accessorized backs, linear elements
- 11 Wall panelling and shelves, linear elements

- 1 Tall units
- 2 Cabinets above tall unit
- 3 High tall units
- 4 Open elements
- 5 Plinths, linear elements
- 6 Finishing sides, complementary elements

DOORS

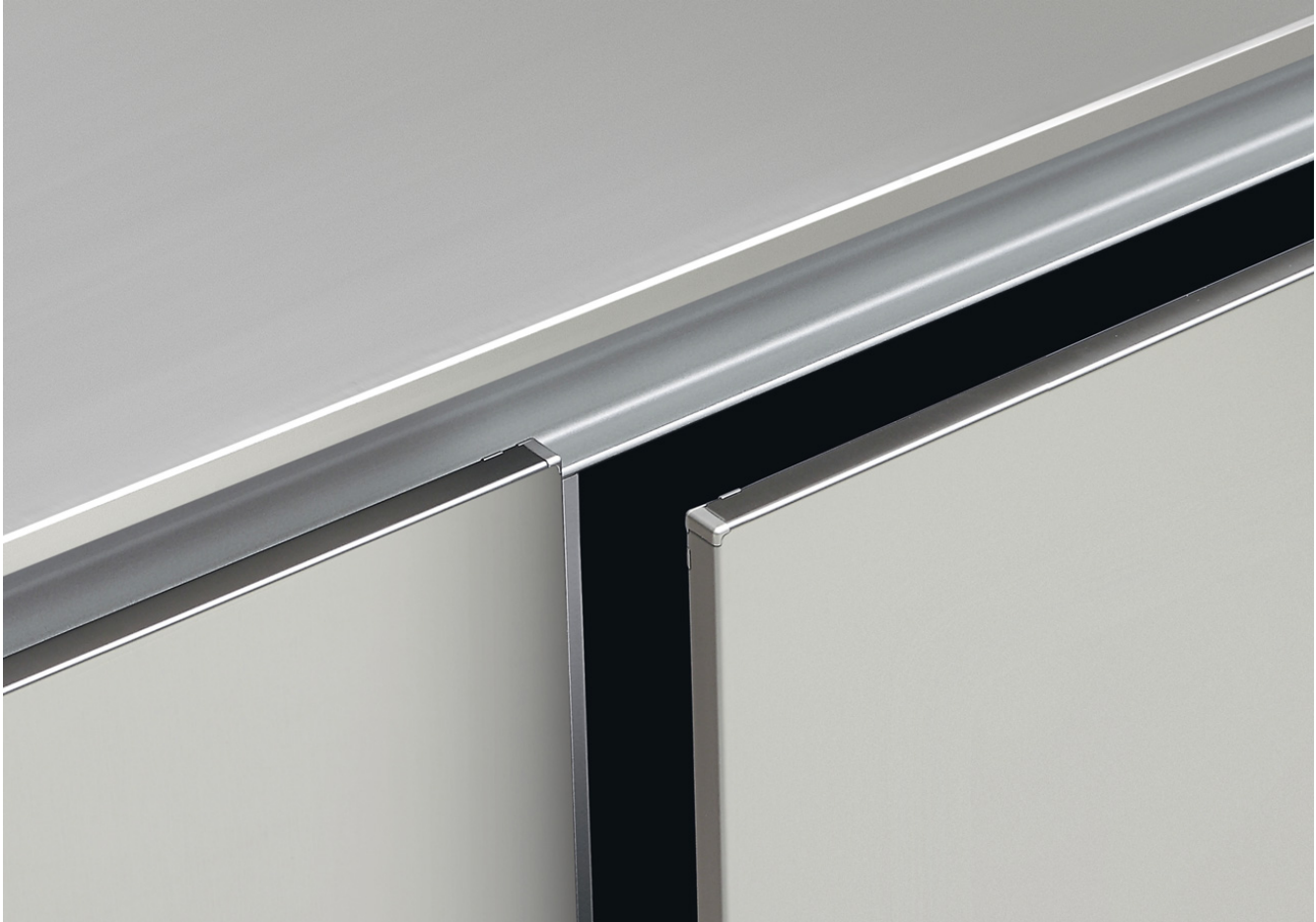

Door thickness 12 mm - 1/2".

FINISHES

SHOWCASES

Thickness 12 mm - 1/2"

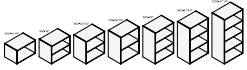
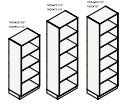

Thickness 26 mm - 1"

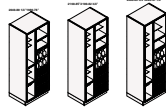
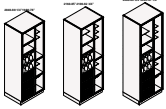

Thickness 26 mm Trail - 1"

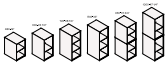
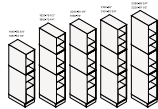

POLIFORM PERSONALISED HOODS

Infinity, modular system

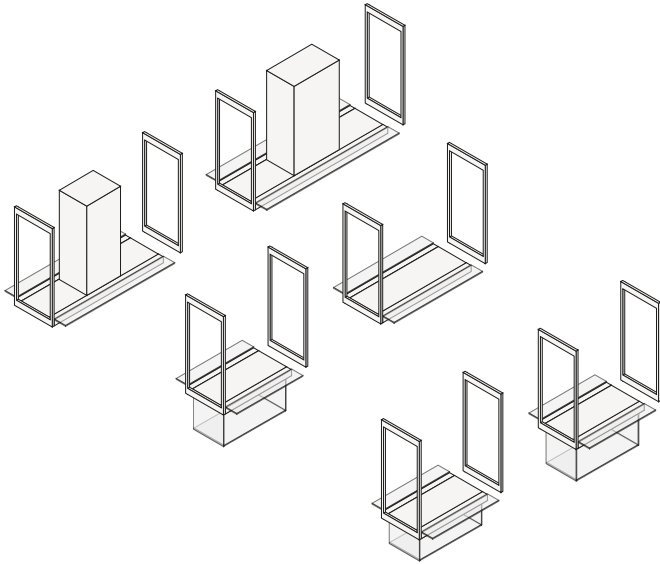

Island and wall hoods

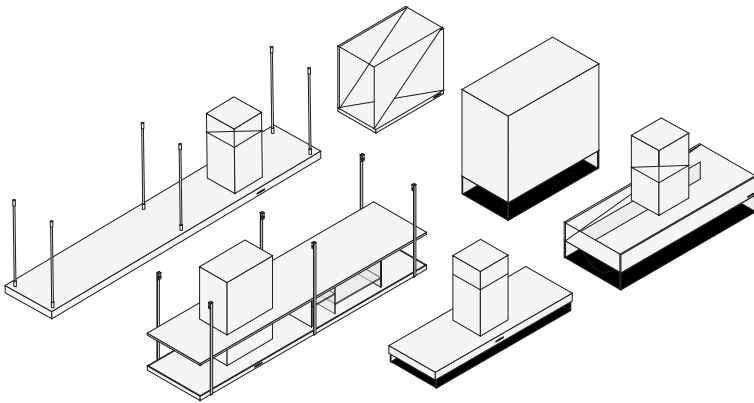

Integrated hoods

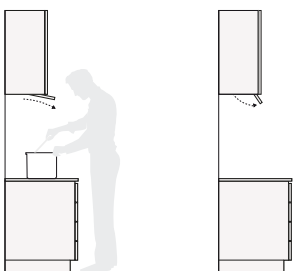

EQUIPPED BACKPANELS

Shaker

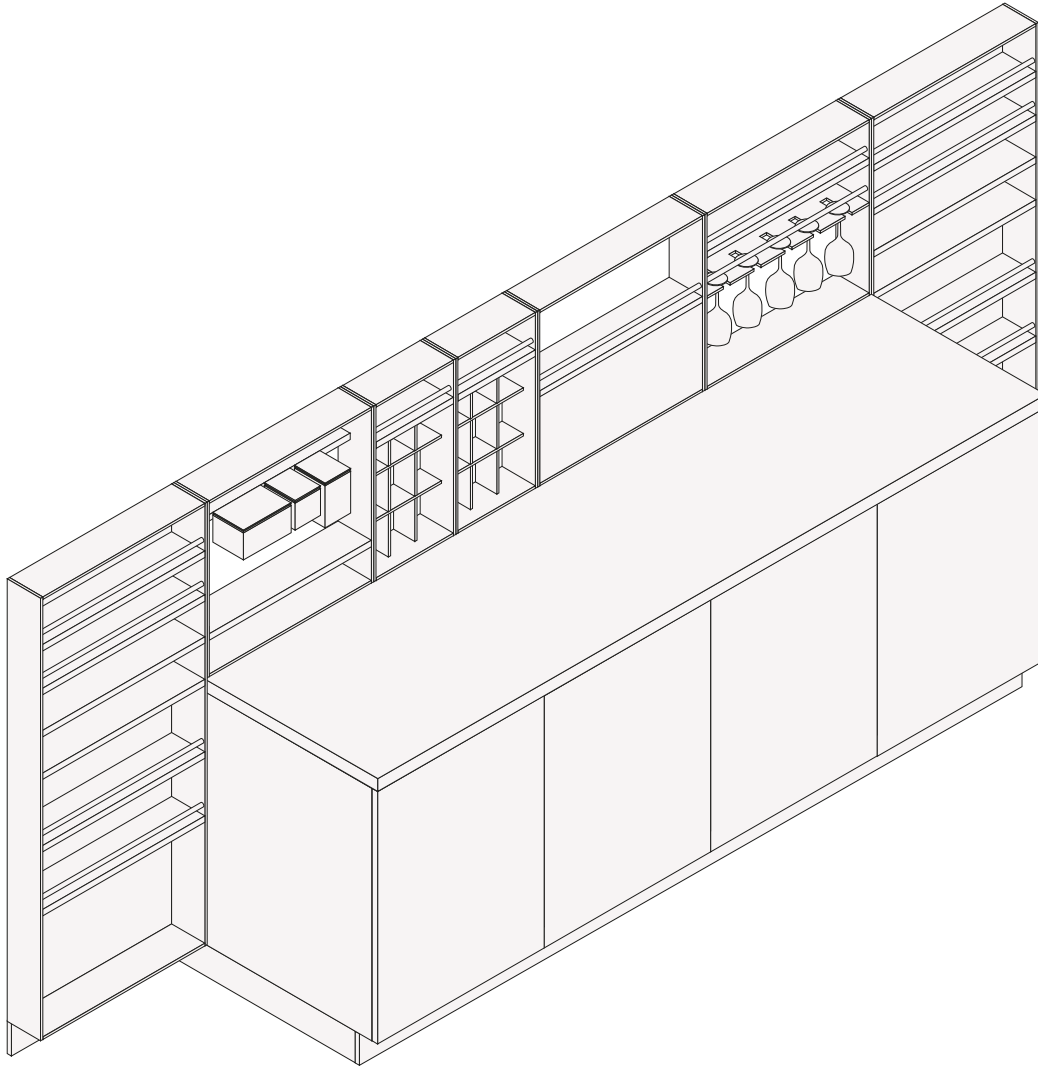

Deep Shaker

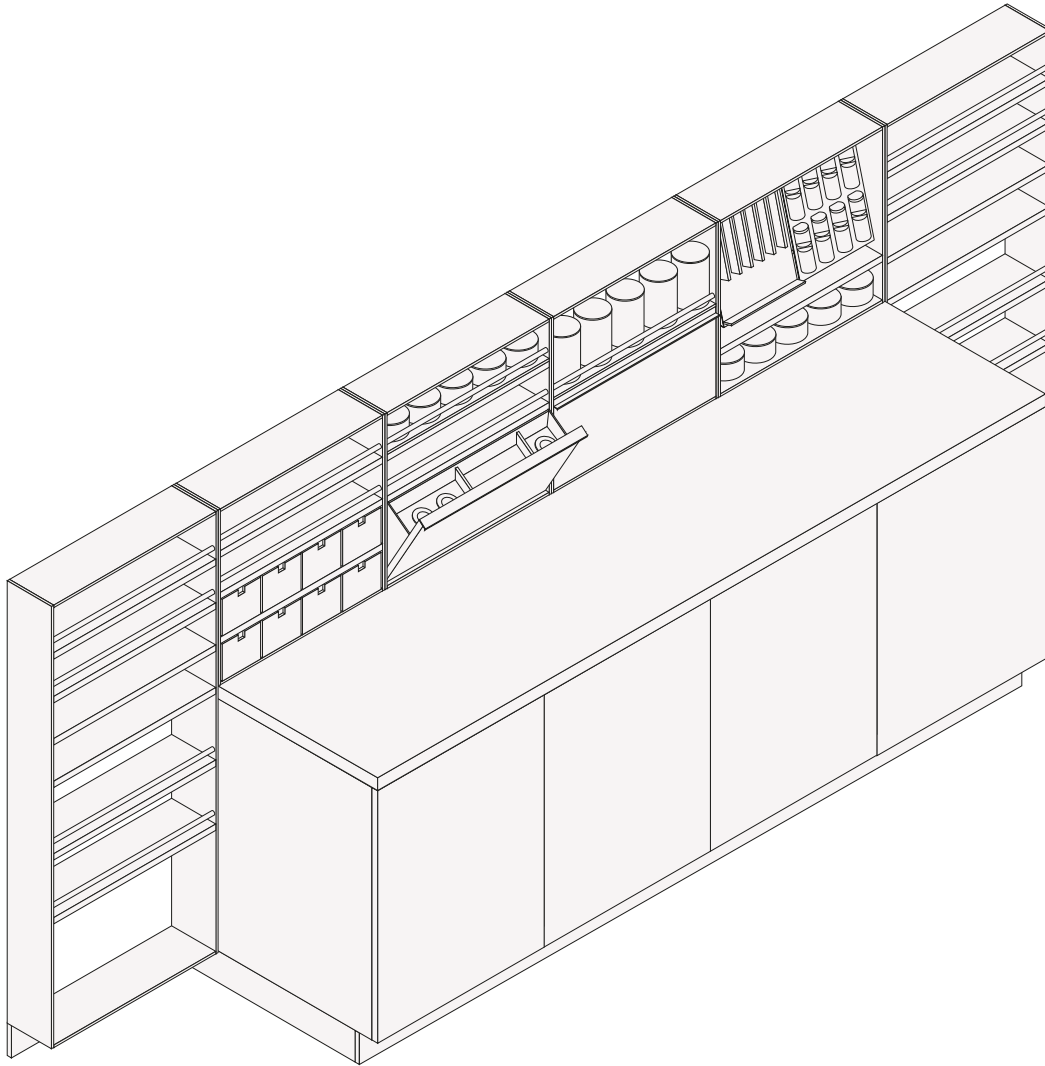

WALL PANNELLING

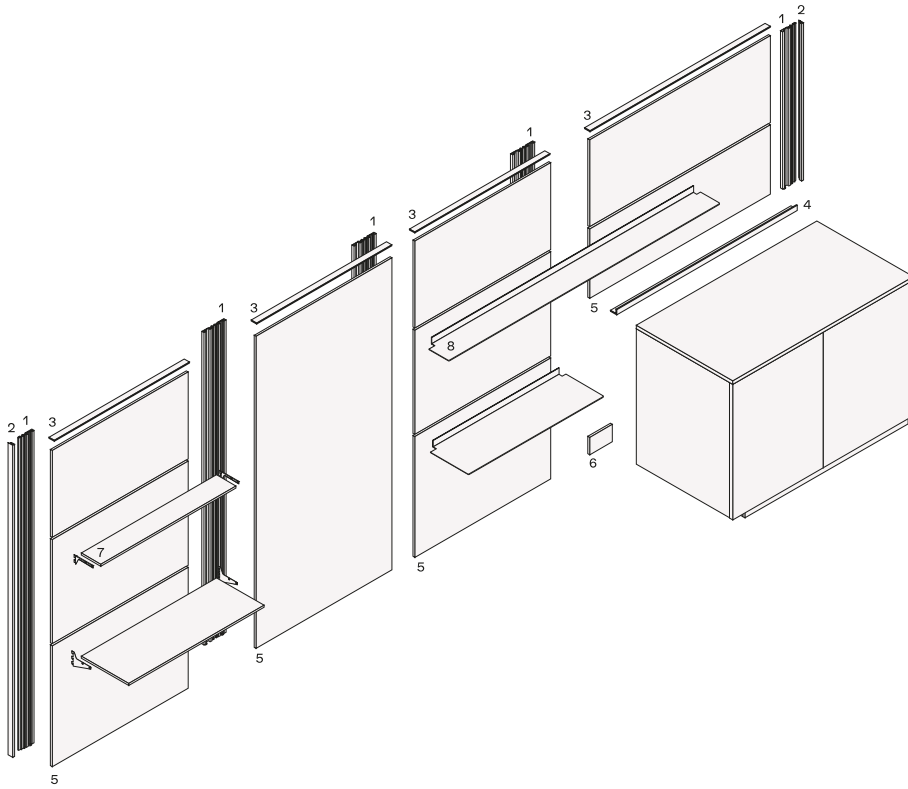

SNACK TOP

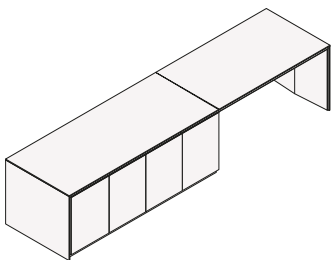
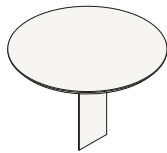
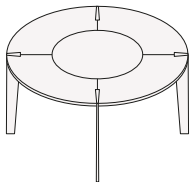
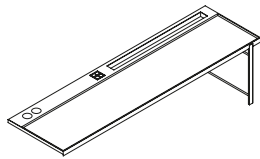
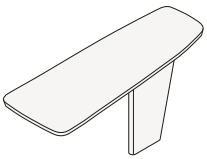
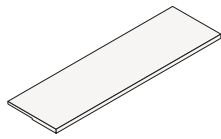
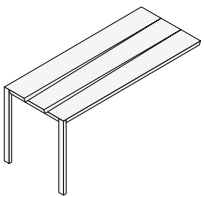
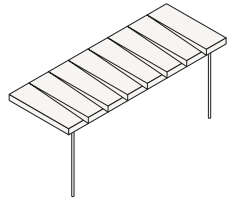
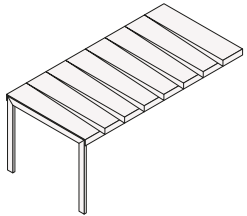

EQUIPMENT

Drawers equipments

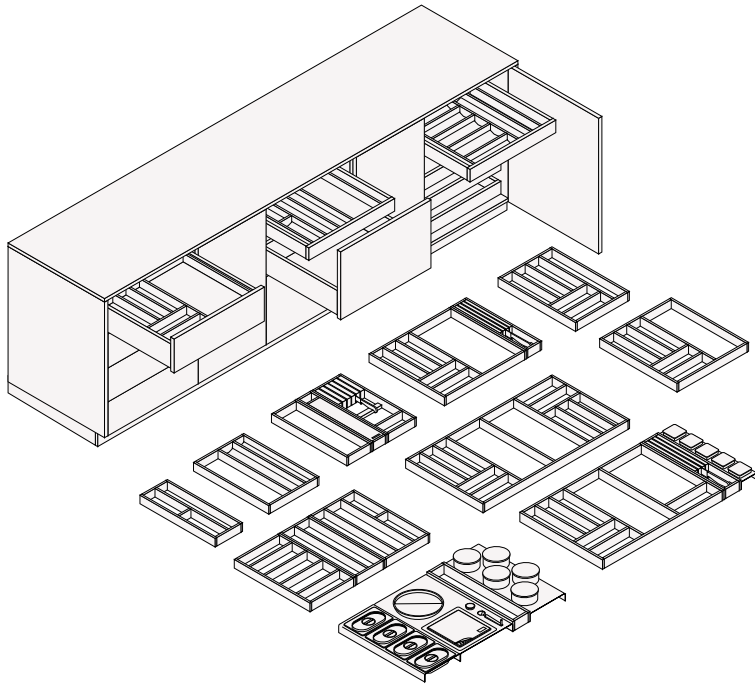

Equipped tall units

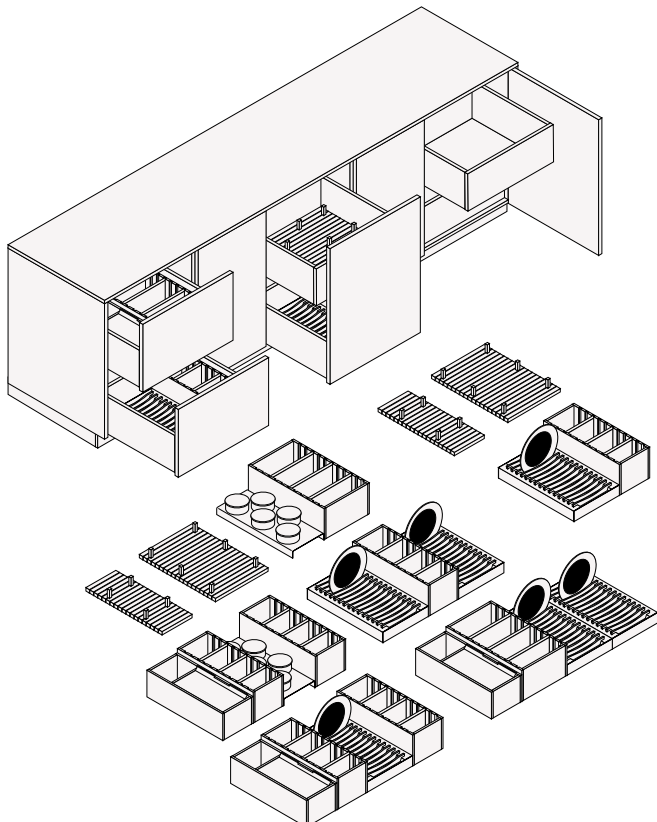

LIGHTING SOLUTIONS

Worktops

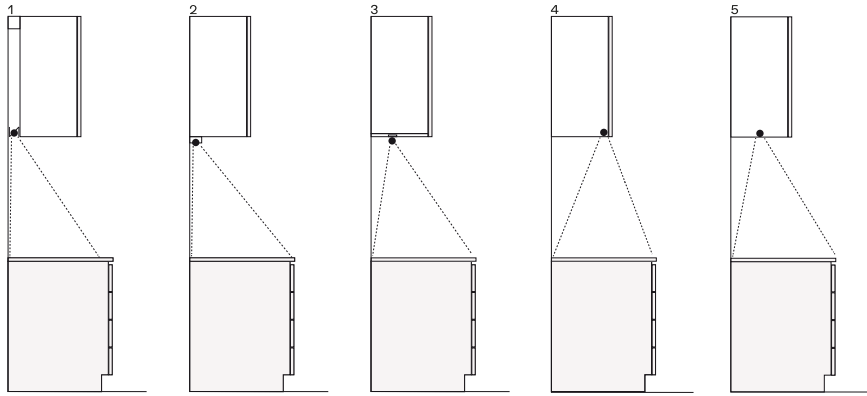

Base

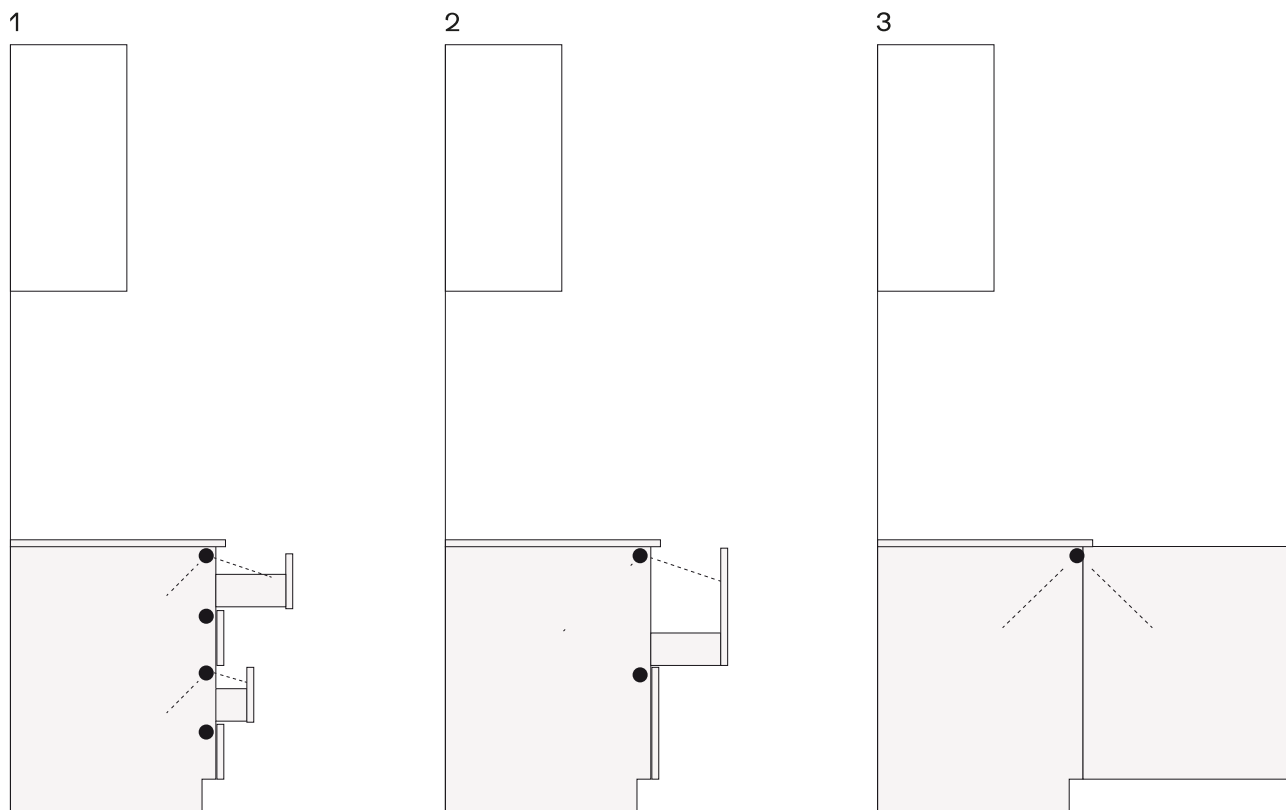

Tall and wall units

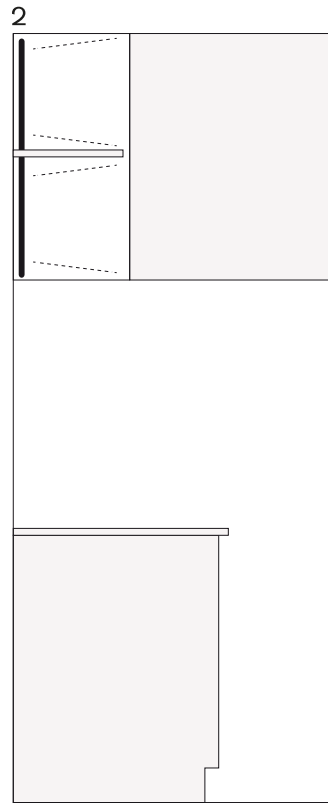
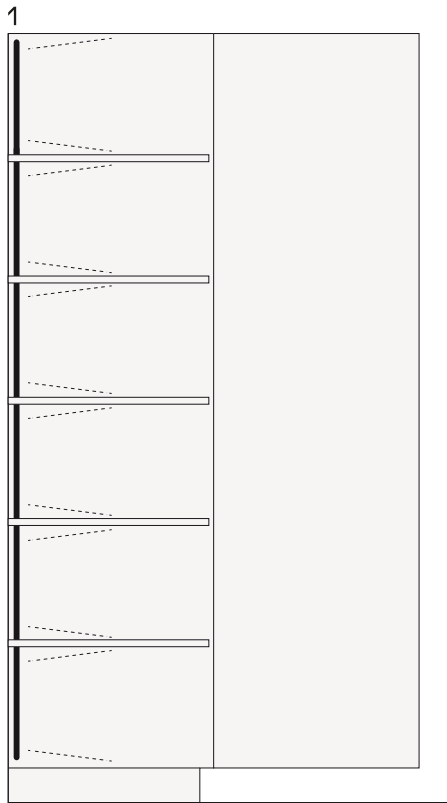

Equipped tall units

