



DESCRIZIONE

Tipologia	Cucine
Spessore anta	22 mm
Spessore piano	12-20-30-40-52 mm
Tipologia apertura basi	Con sagoma
Tipologia aperture colonne	Con sagoma e con distanziale
Tipologie aperture pensili	
Tipologie elementi sopracolonne	Con maniglia tip-on e con distanziale

COMPONENTI

ANTE



Spessore anta 22 mm.

FINITURE

VETRINE

ELEMENTI GIORNO

Spessore 12

Spessore 26

Colonne dx l 750 p 570

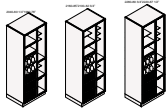

Colonne sx l 750 p 570

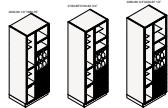

Spessore 26 Trail

Basi l 300 p 570



Colonne l 300 p 570

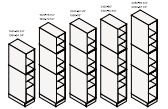

Pensili l 300 p 402

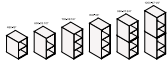

CAPPE PERSONALIZZATE POLIFORM

Sistema modulare Infinity

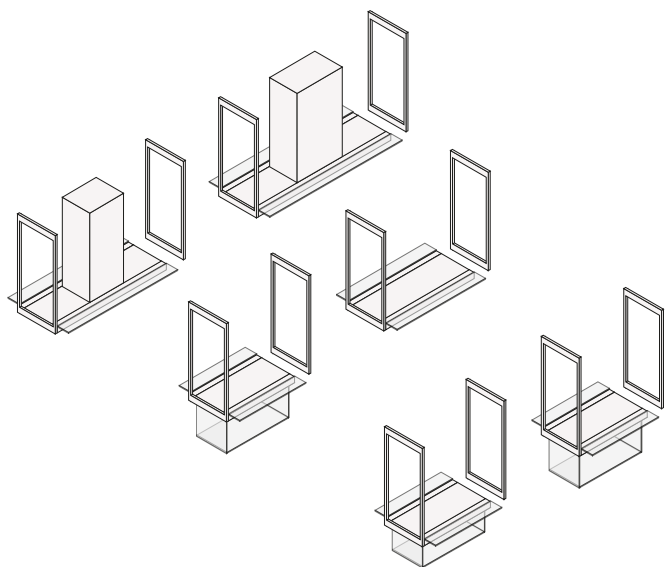

Cappa a parete e a isola

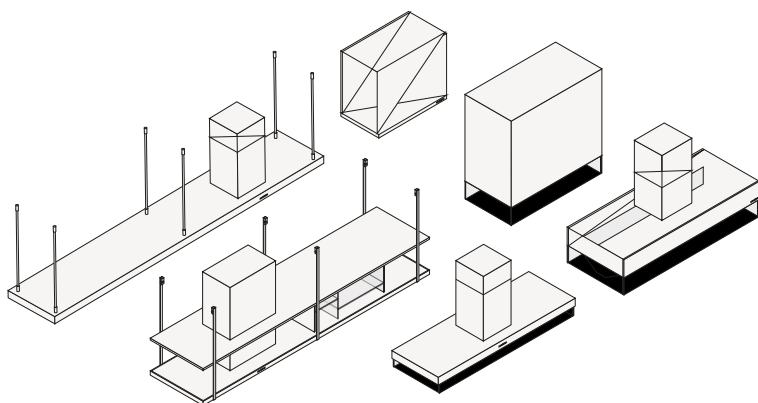

Cappe a incasso

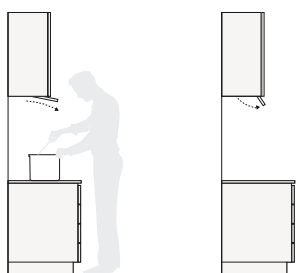

STRUCTURE

Shaker

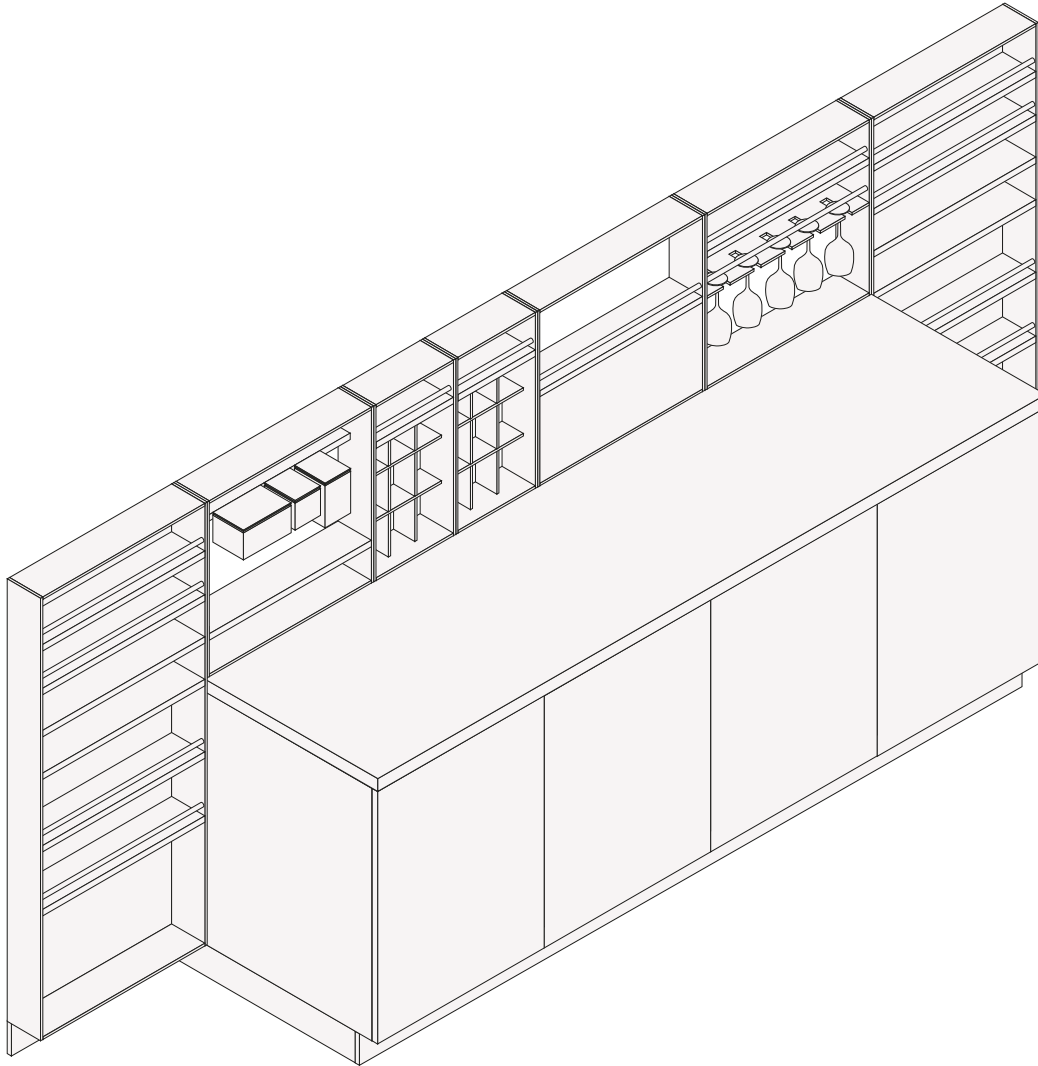

Deep Shaker

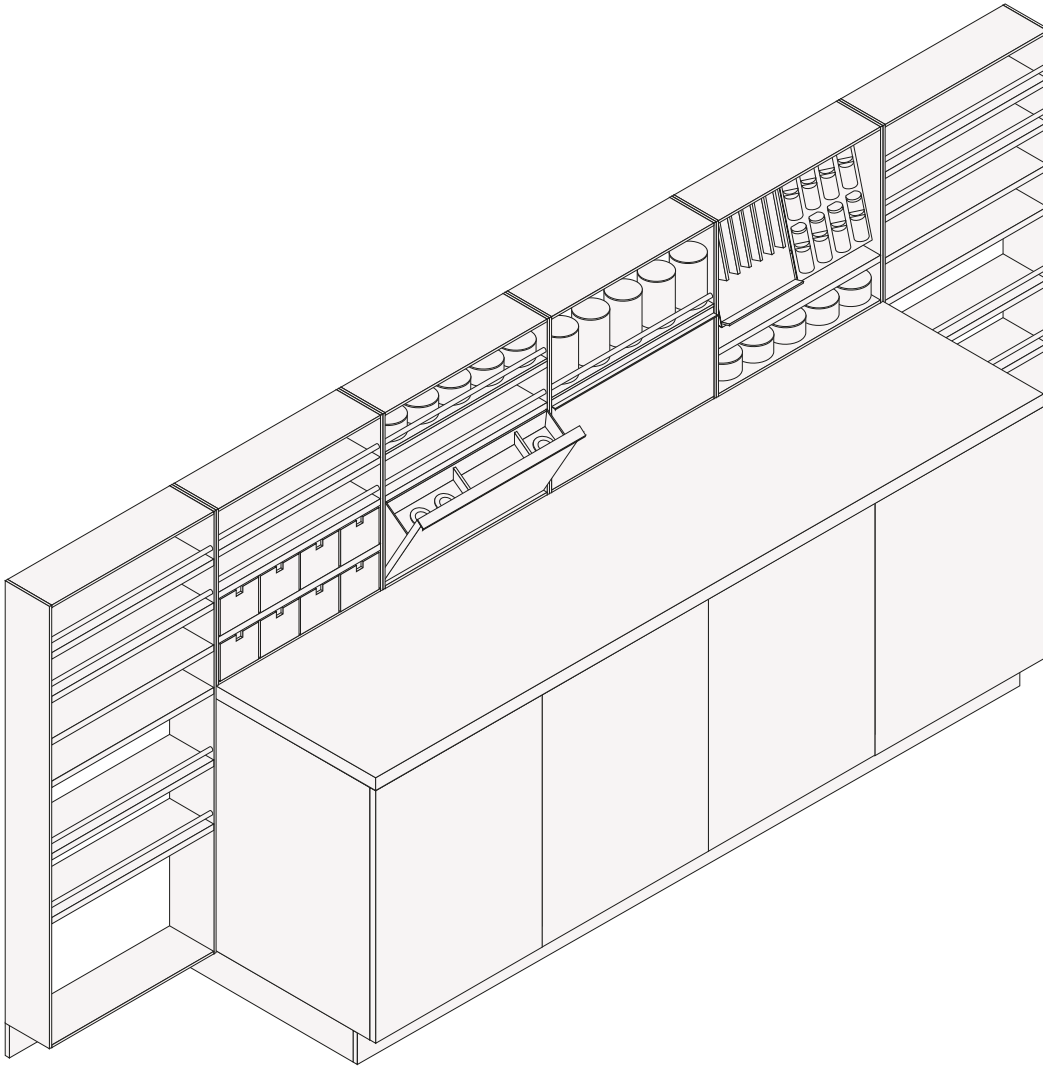

BOISERIE

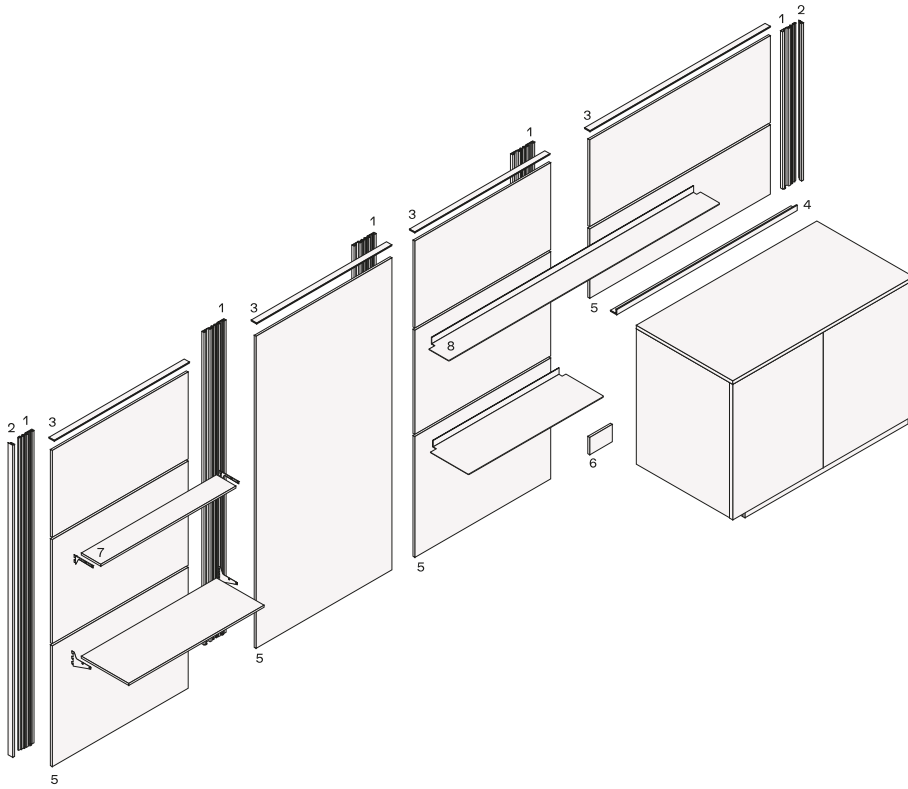

- 1 Montante per fissaggio a muro
- 2 Profilo laterale
- 3 Profilo superiore
- 4 Profilo angolare per appoggio boiserie sul top
- 5 Pannello boiserie
- 6 Pannello boiserie I 150 per tamponamento telaio arretramento zoccolo
- 7 Mensola spessore 12
- 8 Mensola spessore 3

PIANI SNACK

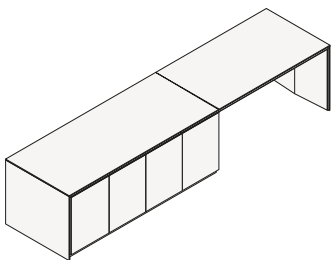
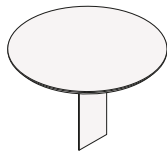
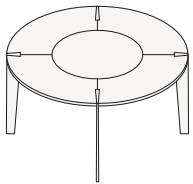
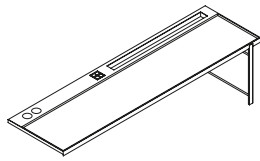
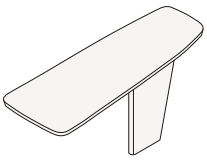
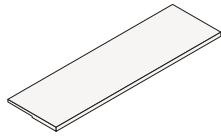
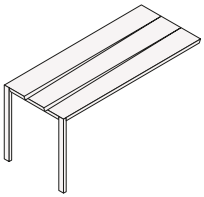
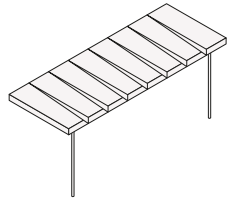
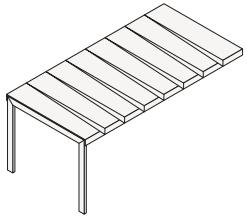

ATTREZZATURE

Attrezzatura cassetti

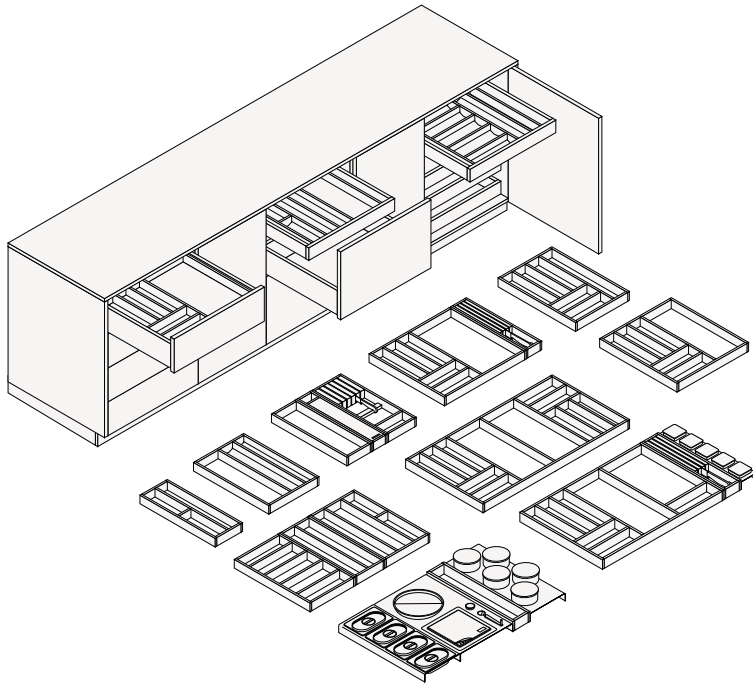

Attrezzatura estrattori

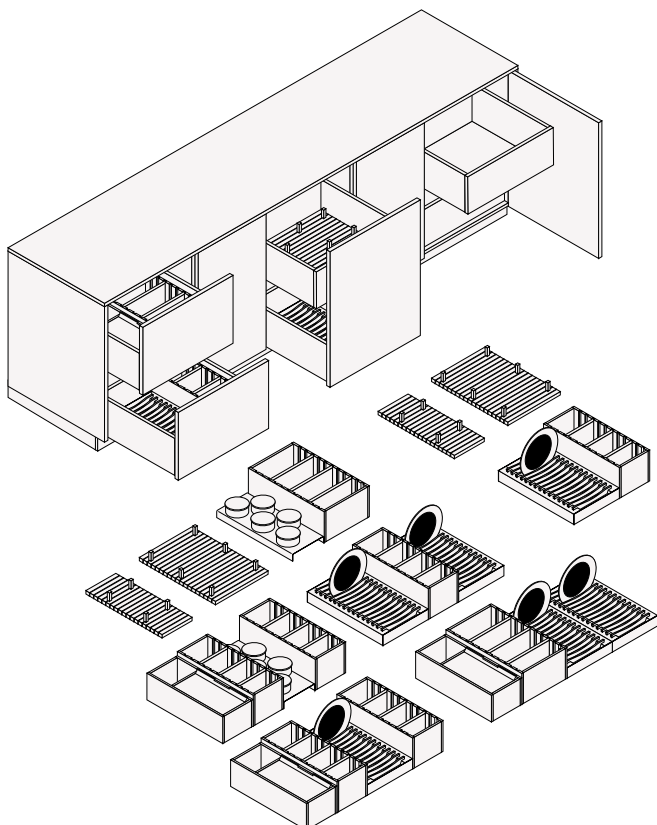

SISTEMI DI ILLUMINAZIONE

Piani di lavoro

Luci esterne pensili

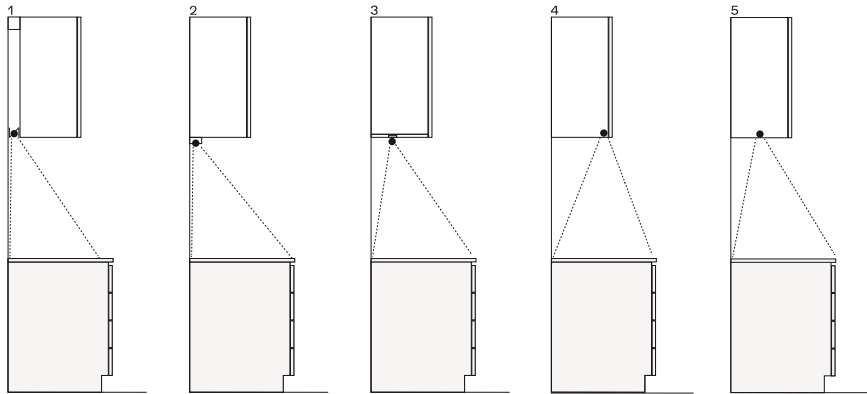

- 1 Barra retro pensile con led, soluzione con pensili avanzati di mm 100
- 2 Barra sotto pensile
- 3 Canalina multiled
- 4 Profilo luminoso multiled per pensili o pensili scolapiatti, utilizzati solo su pensili p 410
- 5 Faretto Dual Color, da incasso nel fondo del pensile

Basi

Luci interne per basi

1

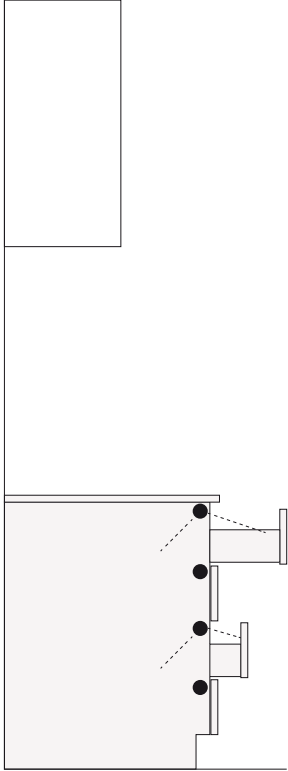

2

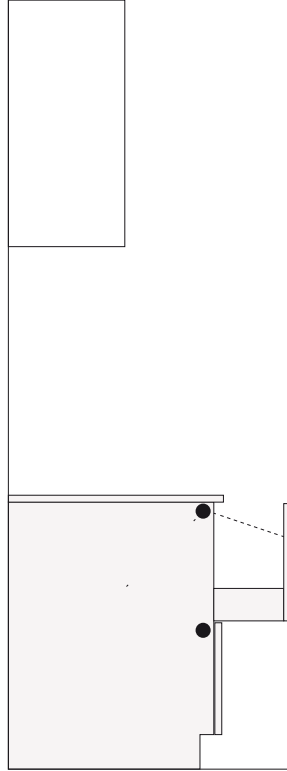

3

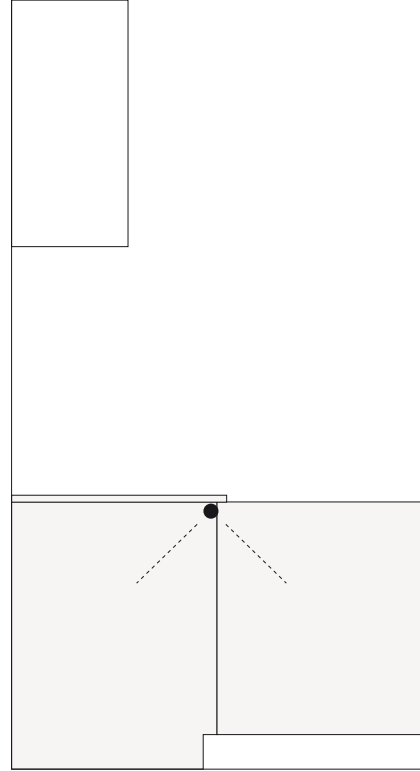

- 1 Cassetti con lampade Kiton multiled
- 2 Estrattori con lampade Kiton multiled
- 3 Anta battente con lampada Kiton multiled

Colonne e pensili

Luci interne per colonne e pensili

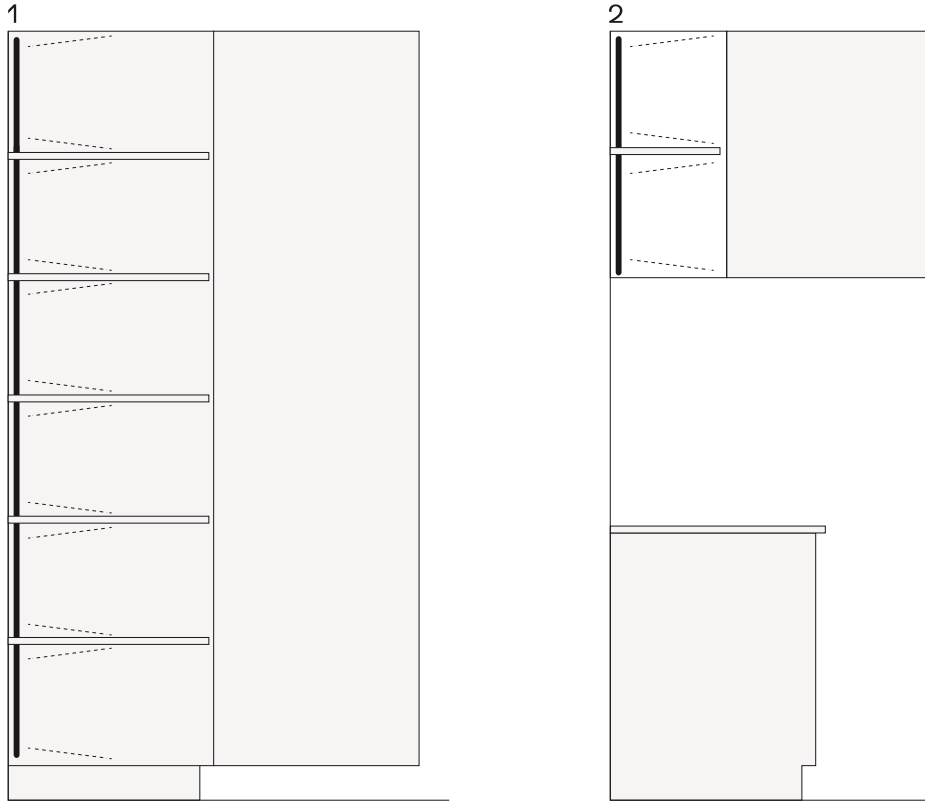

- 1 Colonne con lampade verticali multiled, h da 1320 fino a 2280
- 2 Pensili con lampade verticali multiled, h da 360 fino a 1200

Colonne attrezzate

Luci interne per colonne attrezzate

1

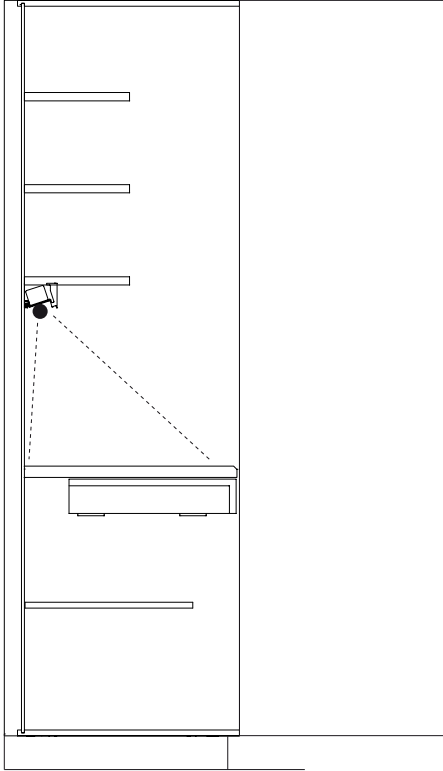

2

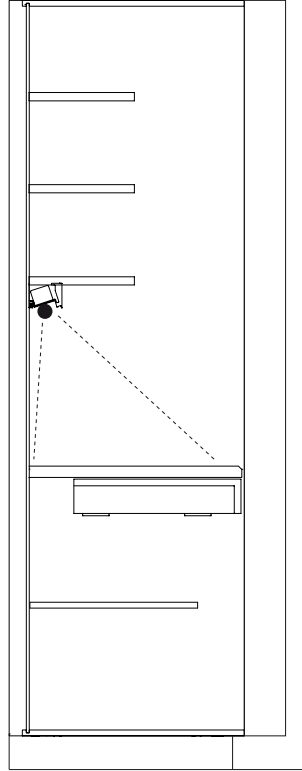

1 Colonne ad apertura totale I 900, 1200

2 Colonne e colonne High con anta a scomparsa, I 1380