



DESCRIPCIÓN

Tipo	Sofá modular sin juntas, libremente combinable
Estructura	Madera y derivados
Cojín de respaldo	Espuma de poliuretano en diferentes densidades
Rodillo	Espuma de poliuretano
Cojín del asiento	Espuma de poliuretano en diferentes densidades
Primer revestimiento	Lona de algodón y plumón
Revestimiento final	Tejido o cuero desenfundable
Base	Tablero de fibra de densidad media barnizado
Cojines opcionales	Lona de algodón y plumón

DIMENSIONES

Elementos modulares

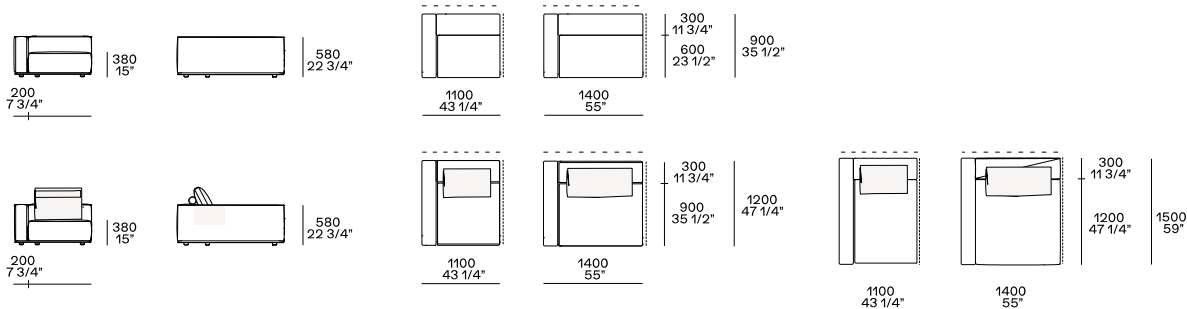

Terminal izquierda-derecha con reposabrazos Slim

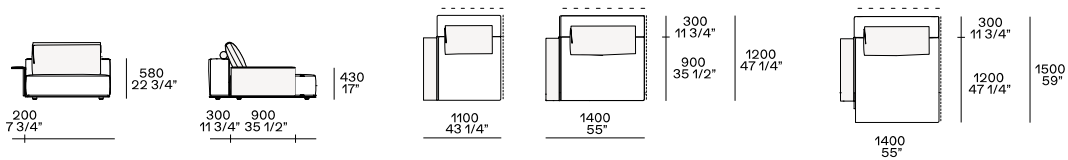

Centrale

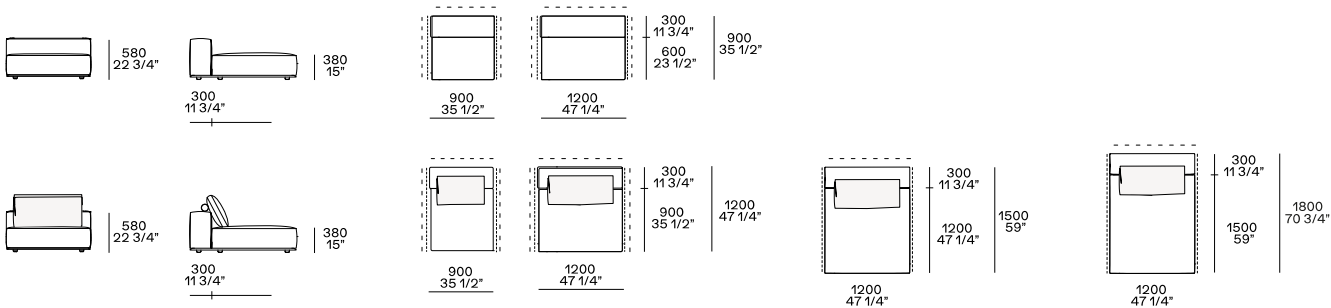

Terminal de isla izquierda-derecha

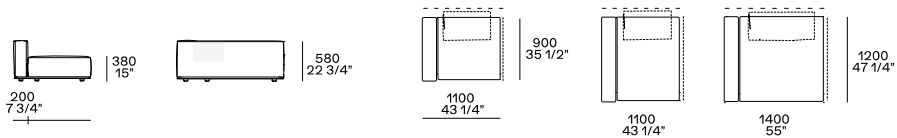

En las composiciones de doble cara, los cojines del respaldo se apoyan contra el respaldo del elemento trasero.

Central con respaldo con balda

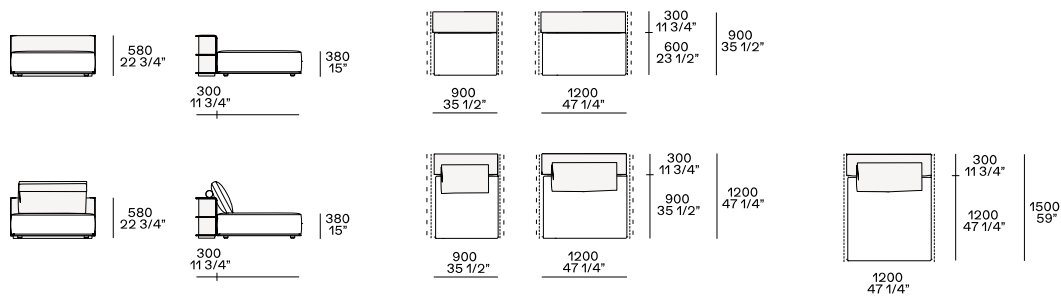

Tumbona

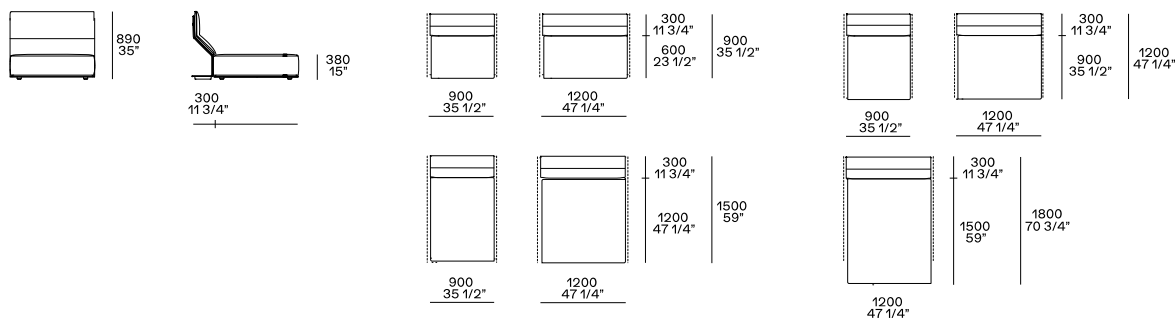

Chaise longue izquierda-derecha con reposabrazos Slim

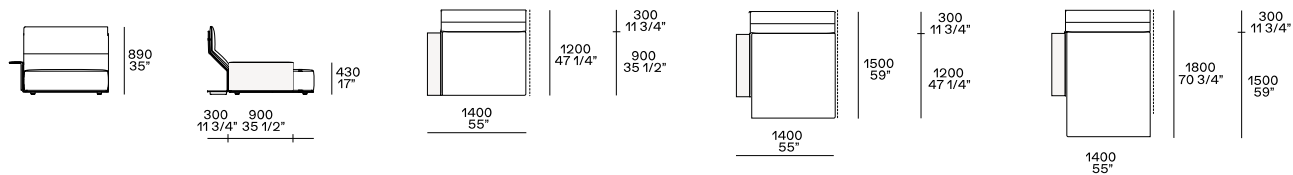

Esquina izquierda-derecha

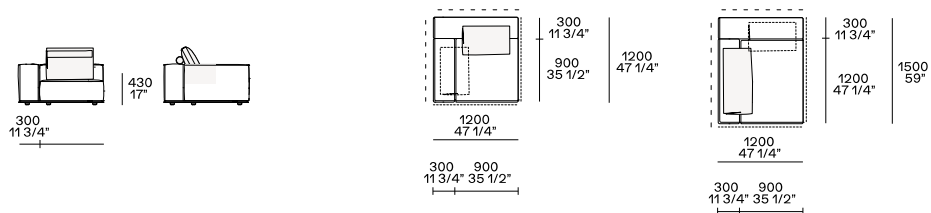

Pouf

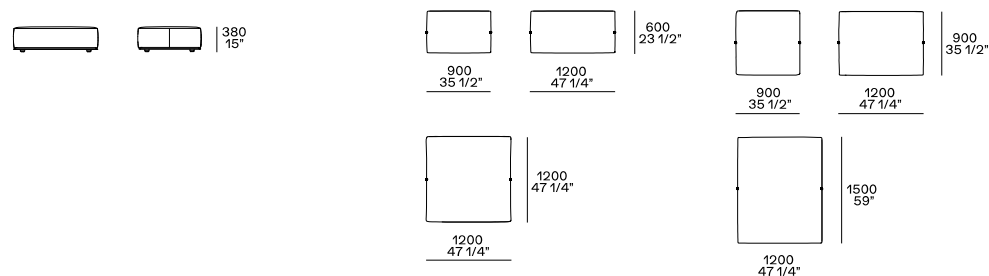

Respaldo móvil

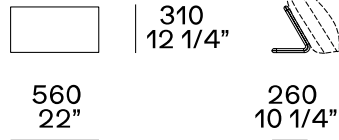
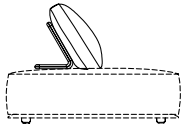

Utilizable solo en puf

Elementos independientes

Chaise longue

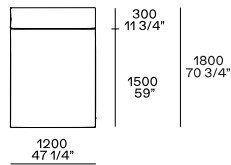
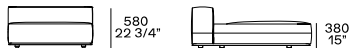

Pouf

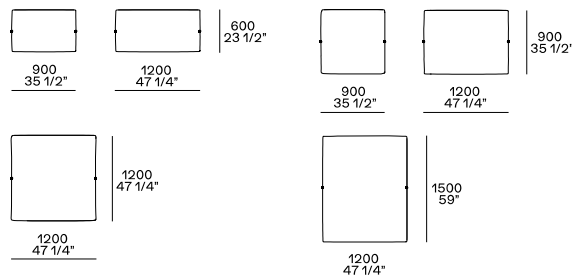

Uso terminal, central, de esquina y de doble cara en todos los lados excepto el módulo modular de doble cara de 1200x600 solo en el lado largo

Respaldo móvil

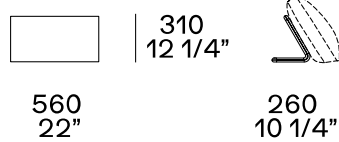
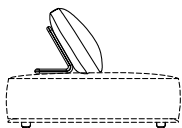

Utilizable solo en puf

Elementos para detrás del sofá

Elemento de sofá retro con estante

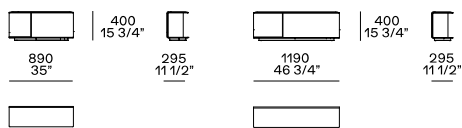

Respaldo de sofá con compartimento abierto

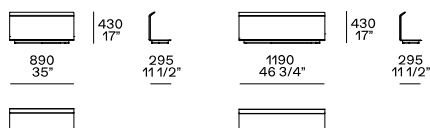

Mesa de centro sofá retro

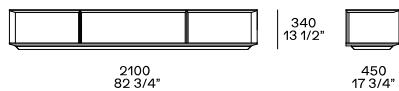
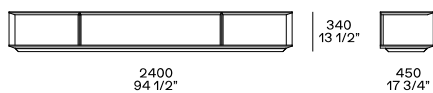
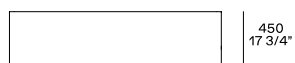
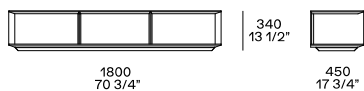

Cajón opcional

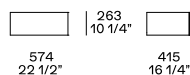

Cojines

Cojines de respaldo con o sin rollo Ø 90

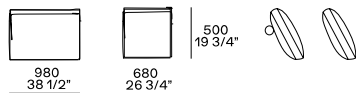

Ancho 680-980 a juego según el ancho de los respaldos

Almohada confort opcional



Reposacabezas

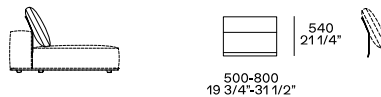

No utilizable en puf, chaise longue, elemento con repisa

Almohada de banda opcional

