

SYDNEY

Jean-Marie Massaud, 2016

Sydney è una collezione composta da divano e tavolini contraddistinti da un'estetica di forte originalità tipica della città multiculturale di cui porta il nome. Con Sydney Poliform esplora inedite possibilità creative rese reali dalla mano di Jean-Marie Massaud e dalla varietà dei materiali disponibili, in un connubio tra geometria pura e grande comfort.



Finiture

Struttura legni e derivati poliuretano a quote differenziate, prerivestimento ovatta di poliestere. Rivestimento finale tessuto sfoderabile tessuto. Cucitura cordoncino 8 colori, escluso per il rivestimento in velluto. Cuscini liberi in tre dimensioni con rivestimento tessuto, cucitura a cordoncino 8 colori (escluso velluto). Piedini in metallo verniciato brown nichel lucido e opaco.

Dimensioni

Terminale
End unit

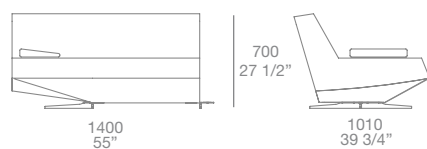

Terminale
End unit

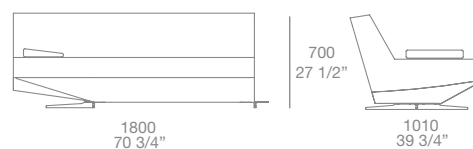

Centrale
Central units

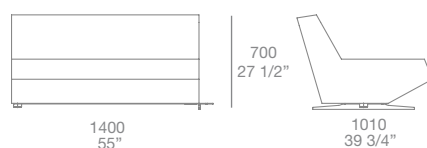

Angolo
Corner

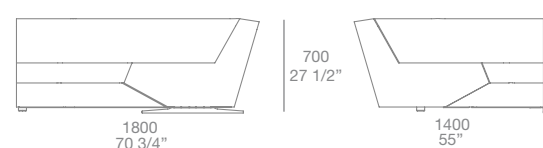

Poliform

SYDNEY

Jean-Marie Massaud, 2016

Dimensioni

Terminale penisola
Peninsula end unit

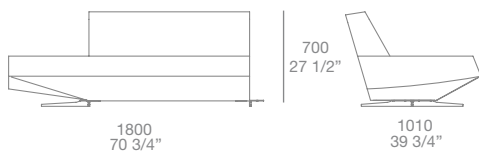

Terminale chaise longue
End unit chaise longue

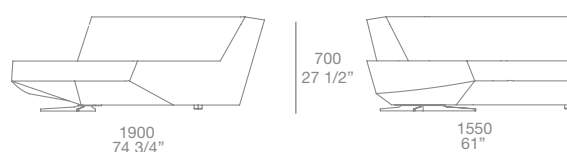

Tavolini / coffee table

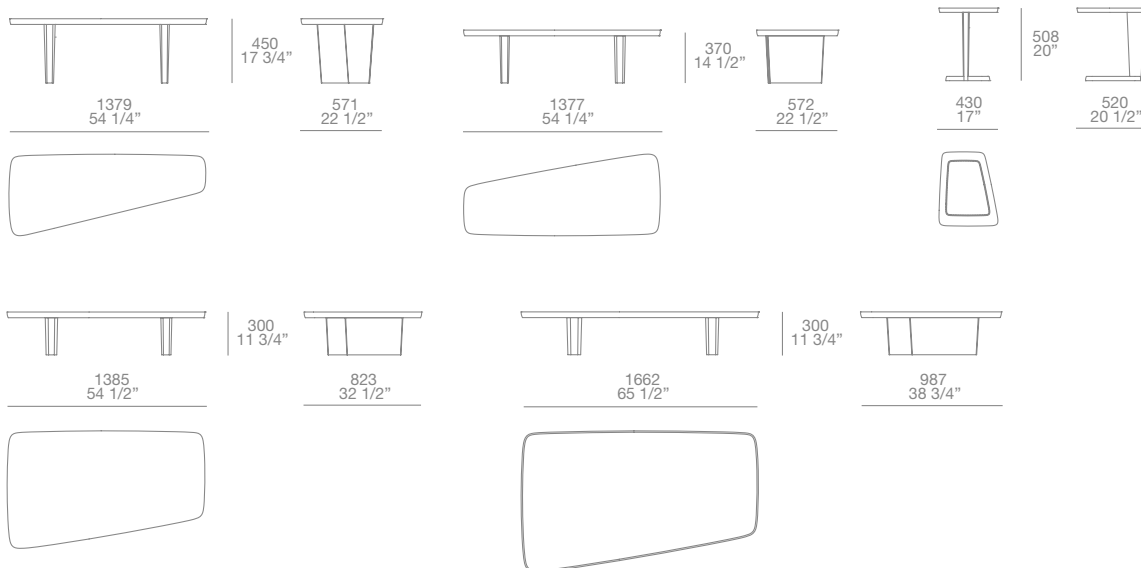

SYDNEY

Jean-Marie Massaud, 2016

Sydney is a sofa and coffee table collection with a highly original aesthetic, typical of the multi-cultural city after which it is named. With Sydney Poliform explores brand new creative possibilities, made reality by the hand of Jean-Marie Massaud in a combination of pure geometry and great comfort.



Finishing

Structure in wood by-products, flexible moulded polyurethane, precovering in polyester padding. Final cover stretched, removable in fabric. Drawstring stitch 8 colours, except for velvet cover. Loose cushions in three dimensions with cover in fabric; drawstring stitch 8 colours except for velvet. Feet in metal mat and glossy brown nickel.

Dimensions

Terminale
End unit

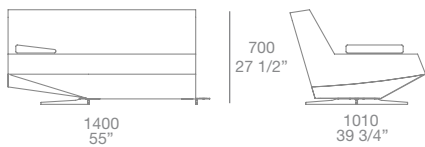

Terminale
End unit



Centrale
Central units

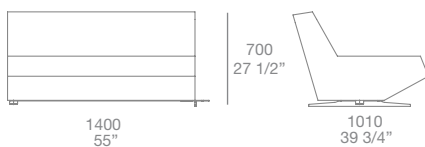

Angolo
Corner

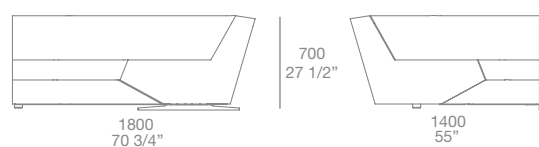

Poliform

SYDNEY

Jean-Marie Massaud, 2016

Dimensions

Terminale penisola
Peninsula end unit

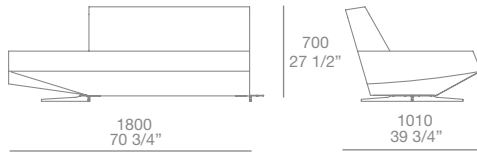

Terminale chaise longue
End unit chaise longue

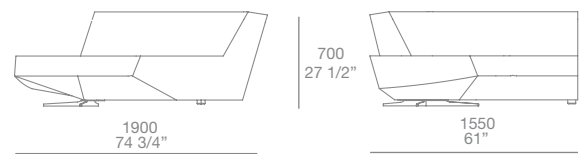

Tavolini / coffee table

